

ISSN 0390-6078

Volume 107

MARCH  
2022 - S1



 **haematologica**

Journal of the Ferrata Storti Foundation

**XVII Congress of the Italian Society of Experimental Hematology  
Roma, Italy, March 31 – April 1-2, 2022**

**ABSTRACT BOOK**

[www.haematologica.org](http://www.haematologica.org)

# **XVII Congress of the Italian Society of Experimental Hematology**

## **COMITATO SCIENTIFICO**

Maria Teresa Voso, *Presidente*  
Paola Guglielmelli, *Vice Presidente*  
Pellegrino Musto, *Past President*  
Francesco Albano  
Niccolò Bolli  
Giulia Falconi, *Segretario*  
Roberta La Starza  
Luca Malcovati, *Rappresentante Haematologica*  
Luca Maurillo  
Stefano Sacchi, *Tesoriere*  
Simona Soverini

## **SEGRETERIA SIES**

Via De' Poeti 1/7 - 40124 Bologna  
Tel. 051 6390906 - Fax 051 4219534  
E-mail: [segreteriasies@ercongressi.it](mailto:segreteriasies@ercongressi.it)  
[www.siesonline.it](http://www.siesonline.it)

## **SEGRETERIA ORGANIZZATIVA**

Studio E.R. Congressi  
Via De' Poeti 1/7 - 40124 Bologna  
Tel. 051 4210559 - Fax 051 4210174  
E-mail: [ercongressi@ercongressi.it](mailto:ercongressi@ercongressi.it)  
[www.ercongressi.it](http://www.ercongressi.it)

# **ABSTRACT BOOK**

# **XVII Congress of the Italian Society of Experimental Hematology**

*Con il contributo non condizionante di*

**diatech**  
pharmacogenetics

# XVII Congress of the Italian Society of Experimental Hematology

## Main Program

.....	1
-------	---

## Best Abstracts

.....	13
-------	----

## Oral Communications

Session	1.	C001-C008	Acute Leukemias 1 .....	19
Session	2.	C009-C016	Chronic Myeloproliferative Disorders 1 .....	23
Session	3.	C017-C024	Plasma Cell Dyscrasias 1.....	27
Session	4.	C025-C032	Lymphoproliferative Diseases .....	31
Session	5.	C033-C040	Next Generation Diagnostics and Non-neoplastic Hematology .....	35
Session	6.	C041-C048	Chronic Myeloproliferative Disorders 2 .....	40
Session	7.	C049-C056	Plasma Cell Dyscrasias 2.....	44
Session	8.	C057-C064	Acute Leukemias 2 .....	48
Session	9.	C065-C072	Immunotherapy and Transplantations .....	52

## Posters

Session	1.	P001-P002	Techniques in the Diagnosis and Follow-up of Hematologic Malignancies .....	57
Session	2.	P003-P009	Myeloproliferative Disorders .....	58
Session	3.	P010-P011	Chronic Myeloid Leukemia .....	61
Session	4.	P012-P019	Myelodysplastic Syndromes .....	62
Session	5.	P020-P033	Acute Leukemias .....	65
Session	6.	P034-P041	Chronic Lymphocytic Leukemia and Chronic Lymphoproliferative Disorders .....	73
Session	7.	P042-P049	Lymphomas.....	78
Session	8.	P050-P061	Monoclonal Gammopathies and Multiple Myeloma .....	82
Session	9.	P062-P063	Stem Cell Transplantation.....	88
Session	10.	P064-P070	Immunotherapy and Cell Therapy .....	90
Session	11.	P071-P073	Benign Hematology (Red Cell Disease Thrombosis and Hemostasis).....	94

# XVII Congress of the Italian Society of Experimental Hematology

## MAIN PROGRAM

### MOLECULAR PATHOGENESIS AND PROGNOSTIC STRATIFICATION: ACUTE MYELOID LEUKEMIA

K. Döhner

Department of Internal Medicine III, University Hospital of Ulm, Germany

With the recent developments of molecular techniques, in particular next-generation sequencing (NGS) technology, we have gained significant insights into the pathogenesis of acute myeloid leukemia (AML). Targeted gene sequencing in large AML cohorts allowed the characterization of the genomic landscape in adult AML. Moreover, novel prognostically relevant secondary and tertiary co-mutation patterns such as the *NPM1/FLT3*-ITD genotype have been identified. Based on these findings the genomic classification could be reassessed showing segregation of AML into 11 non-overlapping molecular classes. One interesting class is represented by the “chromatin-spliceosome” group, which is defined by mutations in splicing factor genes (*SRSF2* or *SF3B1*) and regulators of chromatin and transcription (*ASXL1*, *EZH2*, *MLL*-PTD, or *RUNX1*). Patients (pts) belonging to this class were associated with older age, lower WBC counts, antecedent myeloid disorders, multilineage dysplasia, and inferior outcome. Interestingly, the gene signature of this class is remarkably similar to the signature recently described in secondary AML and therefore contributes to define a uniform and biologically based definition of secondary AML. In core-binding factor leukemias, high-throughput sequencing revealed that frequent alterations in RTK/RAS signaling genes were common in both AML entities. However, also profound differences were identified between the two subsets with strong enrichment for mutations in genes involved in chromatin modification, DNA methylation and in genes encoding for members of the cohesin complex in t(8;21) AML, whereas these mutations were virtually absent in inv(16) AML. Recently, we performed targeted sequencing in 475 *FLT3*-mutated AML pts from the RATIFY trial and evaluated the prognostic and predictive impact of specific clinical variables and gene mutations. We found that co-mutation of *WT1* had a strong negative prognostic effect, whereas co-mutation of *NPM1*, and treatment with midostaurin had a significant beneficial effect on outcome. In addition, we could identify several significant interactions: *WT1:NPM1* mutations, with *NPM1* mutations abrogating the negative impact of *WT*, *WT1* mutation and treatment with midostaurin in that pts with concurrent *WT1* mutation seemed to benefit particularly from midostaurin, and the *NPM1:SMC1A* gene-gene interaction, with pts having both co-mutations showing a particularly good prognosis. Finally, the differential impact of *CEBPA* bZIP and TAD Mutations on outcome has been recently evaluated and a defined monoallelic mutation type was identified to be associated with distinct clinical features and superior outcome similar to biallelic *CEBPA* mutations.

In this lecture novel pathogenic findings in AML and their impact on classification and prognosis in the light of the up-coming AML classification and ELN risk stratification will be discussed.

### MOLECULAR PATHOGENESIS AND PROGNOSTIC STRATIFICATION OF MYELODYSPLASTIC SYNDROMES

M. Cazzola

Fondazione IRCCS Policlinico San Matteo and University of Pavia, Pavia, Italy

Myelodysplastic syndromes (MDS) are myeloid neoplasms characterized by clonal proliferation of hematopoietic stem cells, recurrent genetic abnormalities, myelodysplasia, ineffective hematopoiesis, peripheral blood cytopenia, and high risk of evolution to acute myeloid leukemia (AML).<sup>1</sup> MDS derive from growth and spread of a somatically mutated clone, whose selective advantage is provided by somatic genetic lesions termed driver mutations.<sup>2</sup> The initiating mutation occurs in a hematopoietic stem cell capable of self-renewal, while additional mutations associated with clonal progression may occur also in progenitor cells.<sup>3</sup> Several mutation-driver genes, belonging to different biological pathways, can lead to MDS; most patients have combinations of pathway mutations.<sup>4</sup> Recurrently mutated genes include those of RNA splicing, DNA methylation, histone modification, transcription regulation, DNA repair control, signaling, and cohesin complex. Only 6 genes (*SF3B1*, *TET2*, *SRSF2*, *ASXL1*, *DNMT3A*, and *RUNX1*) are mutated in at least 10% of MDS patients, with a long tail of additional genes that are mutated less frequently.<sup>4</sup> Spliceosome mutations are generally early genetic events that drive clonal dominance and shape the future trajectories of clonal evolution.<sup>5,6</sup> Somatic mutations in genes of DNA methylation and histone modification also drive clonal dominance, while the remaining mutant genes mainly contribute to clonal progression. The paradox of myelodysplastic hematopoiesis is that the founding mutation provides an advantage at stem cell and progenitor cell level, combined with a disadvantage at hematopoietic precursor level.<sup>2</sup> Evolution to AML is a process of clonal selection in which both linear and branching evolutionary patterns may occur.<sup>2</sup> MDS encompass a wide spectrum of conditions with a variable risk of death from complications of cytopenia or evolution to AML.<sup>2</sup> The IPSS-R is currently universally used for risk stratification in MDS.<sup>7</sup> In clinical practice, a cut-off of 3.5 for the IPSS-R score allows clinicians to distinguish between lower-risk (score  $\leq 3.5$ , median survival 5.9 years) and higher-risk (score  $> 3.5$ , median survival 1.5 years) MDS patients. Molecular profiling can improve risk stratification and inform clinical decision making. *SF3B1* mutation defines a relatively indolent disease,<sup>8</sup> while *SRSF2* mutation is invariably associated with aggressive conditions with high risk of progression to AML.<sup>9</sup> A biallelic defect in *TP53* predicts risk of leukemic transformation and death independently of the IPSS-R.<sup>10</sup> The International Working Group for the Prognosis of MDS (IWG-PM) is currently developing the molecular international prognostic scoring system (IPSS-M) for risk stratification in MDS. Using hematologic parameters, cytogenetic abnormalities, and somatic mutations of myeloid genes, the IPSS-M provides a more efficient risk stratification of MDS patients, representing a valuable tool for clinical decision-making.

### References

1. Arber DA, Orazi A, Hasserjian R, Thiele J, Borowitz MJ, Le Beau MM, et al. The 2016 revision to the World Health Organization classification of myeloid

- neoplasms and acute leukemia. *Blood*. 2016;127(20):2391-405.
- Cazzola M. Myelodysplastic syndromes. *N Engl J Med*. 2020;383(14):1358-74.
  - Woll PS, Kjallquist U, Chowdhury O, Doolittle H, Wedge DC, Thongjuea S, et al. Myelodysplastic syndromes are propagated by rare and distinct human cancer stem cells *in vivo*. *Cancer Cell*. 2014;25(6):794-808.
  - Papaemmanuil E, Gerstung M, Malcovati L, Tauro S, Gundem G, Van Loo P, et al. Clinical and biological implications of driver mutations in myelodysplastic syndromes. *Blood*. 2013;122(22):3616-27; quiz 99.
  - Pellagatti A, Armstrong RN, Steeples V, Sharma E, Repapi E, Singh S, et al. Impact of spliceosome mutations on RNA splicing in myelodysplasia: dysregulated genes/pathways and clinical associations. *Blood*. 2018;132(12):1225-40.
  - Shiozawa Y, Malcovati L, Galli A, Sato-Otsubo A, Kataoka K, Sato Y, et al. Aberrant splicing and defective mRNA production induced by somatic spliceosome mutations in myelodysplasia. *Nat Commun*. 2018;9(1):3649.
  - Greenberg PL, Tuechler H, Schanz J, Sanz G, Garcia-Manero G, Sole F, et al. Revised international prognostic scoring system for myelodysplastic syndromes. *Blood*. 2012;120(12):2454-65.
  - Malcovati L, Stevenson K, Papaemmanuil E, Neuberg D, Bejar R, Boulwood J, et al. SF3B1-mutant MDS as a distinct disease subtype: a proposal from the International Working Group for the Prognosis of MDS. *Blood*. 2020;136(2):157-70.
  - Todisco G, Creignou M, Galli A, Guglielmelli P, Rumi E, Roncador M, et al. Co-mutation pattern, clonal hierarchy, and clone size concur to determine disease phenotype of SRSF2(P95)-mutated neoplasms. *Leukemia*. 2021;35(8):2371-81.
  - Bernard E, Nannya Y, Hasserjian RP, Devlin SM, Tuechler H, Medina-Martinez JS, et al. Implications of TP53 allelic state for genome stability, clinical presentation and outcomes in myelodysplastic syndromes. *Nat Med*. 2020;26(10):1549-56.

## EXTRACELLULAR VESICLES: RECENT ADVANCES AND PERSPECTIVES

A. Radeghieri<sup>1,2</sup>, L. Paolini<sup>1,2</sup>, A. Zendrini<sup>1,2</sup>, S. Alacqua<sup>1</sup>, P. Bergese<sup>1,2,3,4</sup>

<sup>1</sup>Department of Molecular and translational medicine, University of Brescia, Italy; <sup>2</sup>CSGI - Consorzio Interuniversitario per lo Sviluppo dei Sistemi a Grande Interfase, Florence, Italy; <sup>3</sup>National Interuniversity Consortium of Materials Science and Technology (INSTM), Florence; <sup>4</sup>Institute for Research and Biomedical Innovation (IRIB) - National Research Council of Italy (CNR), Palermo, Italy

Extracellular vesicles (EVs) are cell-derived heterogeneous soft nanoparticles with outstanding medical translational opportunities. Despite the increased number of EV publications, current knowledge on EVs remains fragmented and sectorial due to technical difficulties hampering their separation and characterization, especially from complex biological fluids. Indeed *in vivo* derived biofluids, such as plasma and urine, are highly susceptible to the influence of pre-analytical variables and are populated by diverse Extracellular nanoparticles.<sup>1</sup> Therefore, EV precise role *in vivo* remains questionable.<sup>2</sup> It is still unclear what are the mechanisms driving the release of distinct EV subpopulations i.e. exosomes, ectosomes (or microvesicles) and apoptotic bodies, how these EV subpopulations change their properties in different biofluids, and also whether definite populations of EVs are preferentially taken up by particular mechanisms. Furthermore the colloidal nature of EVs, *i.e.* their biophysical and nanoscale features (such as size distribution, surface charge, topology, mechanical, optical and interfacial properties) and its relationship to EV function in all the overmentioned contexts is largely overlooked. It is clear that the ability to determine such EV features with a multidisciplinary approach in clinical samples will allow a real breakthrough in EV translational studies.<sup>3</sup> Our research group has been among the first tackling this point featuring one of the first stories of integration of molecular biology, nanotechnology, colloidal and clinical chemistry in EV research. Such approach was applied to understand the pathogenic mechanisms underlying hematological disorders like Multiple Myeloma (MM), fostering differential diagnosis with Monoclonal Gammopathy of Undetermined Significance (MGUS).<sup>4,5</sup> By combining colloidal and nanoscience concepts and technologies we implemented a nanoplasmonic assay exploiting the peculiar interaction of gold nanoparticles with lipid membranes and soluble proteins.<sup>6</sup> This assay together with Atomic force microscopy, Surface Plasmon Resonance, and bio-

chemical analysis, revealed residual protein contaminants hampers EV biological activity<sup>7</sup> and helped to identify novel MM EV features. We then leveraged this perspective to study EVs in the coagulation process, a still very debated theme. By analyzing plasma EVs we revealed active Antithrombin protein travels physisorbed on the surface of EVs conferring them anticoagulant activity, thus reopening the game on the role of EVs in coagulation.<sup>8,9</sup>

## References

- Busatto S, Zendrini A, Radeghieri A, et al. The nanostructured secretome. *Biomater Sci*. Dec 17 2019;8(1):39-63. doi:10.1039/c9bm01007f
- Yates AG, Pink RC, Erdbrugger U, et al. In sickness and in health: The functional role of extracellular vesicles in physiology and pathology *in vivo*: Part I: Health and Normal Physiology: Part I: Health and Normal Physiology. *J Extracell Vesicles*. Jan 2022;11(1):e12151. doi:10.1002/jev.2.12151
- Paolini L, Zendrini A, and Radeghieri A. Biophysical properties of extracellular vesicles in diagnostics. *Biomarkers in Medicine*. 2018;doi:10.2217/bmm-2017-0458
- Di Noto G, Chiarini M, Paolini L, et al. Immunoglobulin Free Light Chains and GAGs Mediate Multiple Myeloma Extracellular Vesicles Uptake and Secondary NfκappaB Nuclear Translocation. *Front Immunol*. 2014;5:517. doi:10.3389/fimmu.2014.00517
- Di Noto G, Bugatti A, Zendrini A, et al. Merging colloidal nanoplasmonics and surface plasmon resonance spectroscopy for enhanced profiling of multiple myeloma-derived exosomes. *Biosens Bioelectron*. Mar 15 2016;77:518-24. doi:10.1016/j.bios.2015.09.061
- Zendrini A, Paolini L, Busatto S, et al. Augmented COLORimetric NANoplasmonic (CONAN) Method for Grading Purity and Determine Concentration of EV Microliter Volume Solutions. *Front Bioeng Biotechnol*. 2019;7:452. doi:10.3389/fbioe.2019.00452
- Paolini L, Zendrini A, Noto GD, et al. Residual matrix from different separation techniques impacts exosome biological activity. *Sci Rep*. 2016;6:23550. doi:10.1038/srep23550
- Buzas EI, Toth EA, Sodar BW, Szabo-Taylor KE. Molecular interactions at the surface of extracellular vesicles. *Semin Immunopathol*. Apr 16 2018;doi:10.1007/s00281-018-0682-0
- Radeghieri A, et al. (2021) Active antithrombin glycoforms are selectively physisorbed on plasma extracellular vesicles bioRxiv 2021.07.16.452649; doi: https://doi.org/10.1101/2021.07.16.452649

## PICK A WORD: HOW EXTRACELLULAR VESICLES DICTATE THE NORMAL AND LEUKEMIC HEMATOPOIETIC LANDSCAPE

D. Forte

Department of Experimental, Diagnostic and Specialty Medicine (DIMES), Institute of Hematology "L. & A. Seragnoli"- IRCCS Azienda Ospedaliero-Universitaria di Bologna, Bologna, Italy

Extracellular Vesicles (EVs) are submicron vesicles released from various cell types including blood cells with pleiotropic effects on targeted cells. Indeed, EVs are emerging as carriers of complex intercellular information able to influence key cell functions such as stem cell renewal and differentiation, inflammation, metabolism and immune surveillance.<sup>1-2</sup> Despite growing evidence on their deep characterization, there is still a huge debate on EV identification partly due to the differences reported in biogenesis mechanisms and composition, as well as to the complexity of EV isolation/characterization methods. Within the bone marrow (BM) niches, where the hematopoietic stem and progenitor cells (HSPCs) reside, EVs are emerging as important key regulators during homeostasis. Interestingly, the cargo of EVs contributes to cell-cell crosstalk via the bloodstream influencing normal hematopoiesis.<sup>3</sup> In particular, EVs may orchestrate specific cell-type commitment, promoting megakaryopoiesis, supporting erythroid differentiation and contributing to the maintenance of HSPC stemness.<sup>4</sup> These functional activities of EVs might be implicated in transfusion and regenerative medicine as well as in the elaboration of targeted therapeutic approaches. However, to date, only few studies reported the EV contribution to hemopoietic stem cells (HSC) maintenance over time. Recently, besides the decline in EV concentration with aging, it has been demonstrated that changes in EV content may drive HSC aging and lead to malignant transformation.<sup>5-6</sup> Of note, EVs may contain tumor-derived materials that act as a reservoir of clinically relevant biomarkers. In this regard, toward preci-

sion medicine, EVs may be considered a promising tool for non-invasive liquid biopsy replacing bone marrow aspirates.<sup>1-2</sup> We and others previously reported that circulating malignant EVs may be diagnostic and prognostic biomarkers in hematological malignancies with the potential of patients' stratification and outcome prediction.<sup>7-8</sup> In the leukemic landscape, EVs from leukemic (stem) cells and/or the tumor niche promote a leukemic-supportive BM microenvironment at the expense of normal hematopoiesis.<sup>3</sup> In fact, leukemic EVs might impair HSPC clonogenicity and increase their mobilization from the BM. On the other side, it has also been observed indirect mechanisms where EVs alter the marrow stromal compartment impairing its supportive role in normal hematopoiesis.<sup>4,5,9</sup> Intriguingly, accumulating evidence describes the modulation of energy metabolism driven by EVs<sup>10</sup>. However, the EV influence on the metabolic regulation of HSC is still elusive. Thus, despite the variety across the studies, the EVs have emerged as one of the most exciting research areas in blood cancers acting as the 'words' given to the key actors within the hematopoietic system. Overall, the challenge for the future is to interpret the EV-driven "words" which are used by the leukemic cells to propagate their malignant messages.

## References

- Trino S, Lamorte D, Caivano A, De Luca L, Sgambato A, Laurenzana I. Clinical relevance of extracellular vesicles in hematological neoplasms: from liquid biopsy to cell biopsy. *Leukemia*. 2021 Mar;35(3):661-678.
- Forte D, Barone M, Palandri F, Catani L. The "Vesicular Intelligence" Strategy of Blood Cancers. *Genes (Basel)*. 2021 Mar 13;12(3):416.
- Butler JT, Abdelhamed S, Kurre P. Extracellular vesicles in the hematopoietic microenvironment. *Haematologica*. 2018 Mar;103(3):382-394.
- normal hematopoiesis and hematological malignancies. *Heliyon*. 2021 Jan 20;7(1):e06030.
- Goldberg LR. Extracellular Vesicles and Hematopoietic Stem Cell Aging. *Arterioscler Thromb Vasc Biol*. 2021 Aug;41(8):e399-e416.
- Grenier-Pleau I, Abraham SA. Extracellular vesicles tell all: How vesicle-mediated cellular communication shapes hematopoietic stem cell biology with increasing age. *Exp Hematol*. 2021 Sep;101-102:7-15.
- with response to ruxolitinib and distinct disease severity in patients with myelofibrosis. *Br J Haematol*. 2019 Jun;185(5):987-991.
- Laurenzana I, et al. Analysis of Amount, Size, Protein Phenotype and Molecular Content of Circulating Extracellular Vesicles Identifies New Biomarkers in Multiple Myeloma. *Int J Nanomedicine*. 2021 May 7;16:3141-3160.
- Samii A, Razmkhah F. Transformation of Hematopoietic Stem and Progenitor Cells by Leukemia Extracellular Vesicles: A Step Toward Leukemogenesis. *Stem Cell Rev Rep*. 2020 Dec;16(6):1081-1091.
- Isaac R, Reis FCG, Ying W, Olefsky JM. Exosomes as mediators of intercellular crosstalk in metabolism. *Cell Metab*. 2021 Sep 7;33(9):1744-1762.

## EXTRACELLULAR VESICLES AND THEIR ROLE IN TUMOR MICROENVIRONMENT.

I. Tanasi, N. Turazzi, A. Russignan, M. Krampera

Department of Medicine, Section of Hematology, University of Verona, Italy

Extracellular vesicles (EVs) are membrane-surrounded cellular particles released by virtually any cell type, containing a cargo of bioactive molecules, including lipids, proteins, and nucleic acids.<sup>1</sup> EVs are released in physiological and pathological conditions and act as a very efficient intercellular communication system by releasing their content into target cells, thus affecting their fate and influencing several biological processes.<sup>2</sup> In different types of cancers, including hematological neoplasms, EVs have emerged as new critical players, contributing to tumor-to-stroma, stroma-to-tumor, and tumor-to-tumor cell communication. The bone marrow (BM) microenvironment includes hematopoietic progenitors (HSCs) and BM stromal components, i.e. endothelial cells, adipocytes and mesenchymal stromal cells (MSCs). MSCs are multipotent cells exhibiting self-renewal potential and intrinsic multilineage differentiation, thus representing an essential component of the BM hematopoietic niche.<sup>3</sup> In addition to their role in normal hematopoiesis, several studies suggest the involvement of MSCs and their released exosomes in the pathogenesis of HM.<sup>3,4</sup> Indeed, growing evidence supports the hypothesis

of a vicious circle among BM stromal cells and malignant cells, in which EVs represent an important communication tool (Figure 1). By targeting and modifying stromal and endothelial cells in the BM niche, tumor-derived EVs may reprogram the bone marrow (BM) microenvironment to establish a clonal hematopoietic niche.<sup>5</sup> (Kumar 2018) Also, these functional modifications induce the formation of a permissive tumor microenvironment, which in turn may influence cancer cells proliferation, survival, and migration.<sup>6,7</sup> Additionally, stromal-derived exosomes could also affect drug sensitivity of malignant cells,<sup>8,9</sup> and the modified tumor-microenvironment could represent a sanctuary site for resistant clones and the fertile ground for late relapse.

Accordingly, the pharmacological inhibition of stromal EVs biogenesis, release or uptake led to reduced cancer cell survival and proliferation and, interestingly, suppressed the stromal protective effect on malignant cells.<sup>10</sup>

In conclusion, stromal cell-derived EVs display great potential as therapeutic targets to restore normal hematopoiesis and disrupt the abnormal interactions between stromal and cancer cells, preventing the supportive role of BM microenvironment in hematological diseases development and progression and favoring the achievement of more profound and sustained remissions.

Notwithstanding, further efforts are needed to answer many unsolved questions related to the clinical use of EVs.

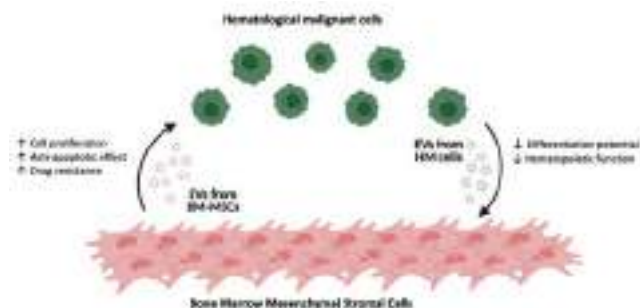

Figure 1. Extracellular vesicles-based cross-talk between bone marrow microenvironment and hematological malignant cells. Legend: EVs= extracellular vesicles; HM= hematological malignant; BM-MSCs=bone marrow-mesenchymal stromal cells.

## References

- Zaborowski, M.P.; Balaj, L.; Breakefield, X.O.; Lai, C.P. Extracellular Vesicles: Composition, Biological Relevance, and Methods of Study. *Bioscience* 2015, 65, 783–797, doi:10.1093/biosci/biv084.
- Mathieu, M.; Martin-Jaular, L.; Lavieu, G.; Théry, C. Specificities of Secretion and Uptake of Exosomes and Other Extracellular Vesicles for Cell-to-Cell Communication. *Nat Cell Biol* 2019, 21, 9–17, doi:10.1038/s41556-018-0250-9.
- Adamo, A.; Dal Collo, G.; Bazzoni, R.; Krampera, M. Role of Mesenchymal Stromal Cell-Derived Extracellular Vesicles in Tumor Microenvironment. *Biochim Biophys Acta Rev Cancer* 2019, 1871, 192–198, doi:10.1016/j.bbcan.2018.12.001.
- Barrera-Ramirez, J.; Lavoie, J.R.; Maganti, H.B.; Stanford, W.L.; Ito, C.; Sabloff, M.; Brand, M.; Rosu-Myles, M.; Le, Y.; Allan, D.S. Micro-RNA Profiling of Exosomes from Marrow-Derived Mesenchymal Stromal Cells in Patients with Acute Myeloid Leukemia: Implications in Leukemogenesis. *Stem Cell Rev Rep* 2017, 13, 817–825, doi:10.1007/s12015-017-9762-0.
- Kumar, B.; Garcia, M.; Weng, L.; Jung, X.; Murakami, J.L.; Hu, X.; McDonald, T.; Lin, A.; Kumar, A.R.; DiGiusto, D.L.; et al. Acute Myeloid Leukemia Transforms the Bone Marrow Niche into a Leukemia-Permissive Microenvironment through Exosome Secretion. *Leukemia* 2018, 32, 575–587, doi:10.1038/leu.2017.259.
- Roccaro, A.M.; Sacco, A.; Maiso, P.; Azab, A.K.; Tai, Y.-T.; Reagan, M.; Azab, F.; Flores, L.M.; Campigotto, F.; Weller, E.; et al. BM Mesenchymal Stromal Cell-Derived Exosomes Facilitate Multiple Myeloma Progression. *J. Clin. Invest.* 2013, 123, 1542–1555, doi:10.1172/JCI66517.
- Crompton, E.; Van Damme, M.; Pieters, K.; Vermeersch, M.; Perez-Morga, D.; Mineur, P.; Maerevoet, M.; Meuleman, N.; Bron, D.; Lagneaux, L.; et al. Extracellular Vesicles of Bone Marrow Stromal Cells Rescue Chronic Lymphocytic Leukemia B Cells from Apoptosis, Enhance Their Migration and Induce Gene Expression Modifications. *Haematologica* 2017, 102, 1594–1604, doi:10.3324/haematol.2016.163337.

8. Viola, S.; Traer, E.; Huan, J.; Hornick, N.I.; Tyner, J.W.; Agarwal, A.; Loriaux, M.; Johnstone, B.; Kurre, P. Alterations in Acute Myeloid Leukaemia Bone Marrow Stromal Cell Exosome Content Coincide with Gains in Tyrosine Kinase Inhibitor Resistance. *Br. J. Haematol.* 2016, 172, 983–986, doi:10.1111/bjh.13551.
9. Liu, Y.; Song, B.; Wei, Y.; Chen, F.; Chi, Y.; Fan, H.; Liu, N.; Li, Z.; Han, Z.; Ma, F. Exosomes from Mesenchymal Stromal Cells Enhance Imatinib-Induced Apoptosis in Human Leukemia Cells via Activation of Caspase Signaling Pathway. *Cytotherapy* 2018, 20, 181–188, doi:10.1016/j.jcyt.2017.11.006.
10. Zheng, Y.; Tu, C.; Zhang, J.; Wang, J. Inhibition of Multiple Myeloma-derived Exosomes Uptake Suppresses the Functional Response in Bone Marrow Stromal Cell. *Int J Oncol* 2019, 54, 1061–1070, doi:10.3892/ijo.2019.4685.

## CIRCULAR RNAS IN PEDIATRIC T-CELL ACUTE LYMPHOBLASTIC LEUKEMIA: NEW BIOMARKERS

A. Buratin<sup>1,2</sup>, C. Borin<sup>3</sup>, E. Gaffo<sup>1</sup>, B. Palhais<sup>4</sup>, A. Dal Molin<sup>1</sup>, C. Tretti<sup>3,5</sup>, M. Paganin<sup>1,3</sup>, V. Serafin<sup>3,5</sup>, J. Roels<sup>4</sup>, J. Morscio<sup>4</sup>, G. Germano<sup>3,5</sup>, T. Taghon<sup>4</sup>, G. te Kronnie<sup>1</sup>, P. Van Vlierberghe<sup>4</sup>, S. Bresolin<sup>3,5</sup>, S. Bortoluzzi<sup>1</sup>

<sup>1</sup>Department of Molecular Medicine, University of Padova, Padova, Italy; <sup>2</sup>Department of Biology, University of Padova, Padova, Italy; <sup>3</sup>Onco-hematology, stem cell transplant and gene therapy laboratory, IRP-Istituto di Ricerca Pediatrica, Padova, Italy; <sup>4</sup>Cancer Research Institute Ghent (CRIG), Ghent, Belgium; <sup>5</sup>Department of Women's and Children's Health, University of Padova, Padova, Italy

Circular RNAs (circRNAs) are abundantly expressed in the hematopoietic compartment, and their dysregulation can drive oncogenesis. CircRNAs regulate cellular processes through interactions with microRNAs or proteins and encode peptides<sup>1–3</sup>. Previous studies of gene, miRNA, and lncRNA expression contributed to determining the molecular networks involved in T-cell Acute Lymphoblastic Leukemia (T-ALL), a disease for which there is still a high need for a better understanding of the underlying mechanisms, and to define new biomarkers and targetable molecules. The study of circRNAs adds a new layer to the transcriptomic characterization of the pediatric T-ALL. First, we analyzed with our in-house developed software CirComPara2<sup>4</sup> RNA-seq data of 25 T-ALL patients of five cytogenetic subgroups (immature, HOXA overexpressing, TLX1, TLX3, TAL1, and LMO2 rearranged) and five sorted populations of developing thymocytes as normal counterpart. Almost 70 thousands circRNAs were detected and the 3,447 most expressed underwent further study, revealing a dramatic dysregulation of the circRNAome in T-ALL<sup>5</sup>: 944 circRNAs were significantly differentially expressed in T-ALL compared with normal thymocytes, mostly upregulated in malignant cells. These included circRNAs with well-known oncogenic potential, other from genes linked to leukemogenesis, and several circRNAs not yet characterized. Of note, circRNAs ectopically expressed with specificity for each oncogenic group defined circRNA signatures of T-ALL molecular subtypes. For each T-ALL subgroup, a circRNA-miRNA-gene interaction network was obtained, defining intriguing new oncogenic axes. Functional studies conducted using transient circRNA silencing *in vitro* indicated that circZNF609 plays an oncogenic role in T-ALL, sustaining cell viability while negatively impacting apoptosis. CircFBXW7 was highly expressed in T-ALL, with extreme heterogeneity in our cohort (Figure 1A). Activation of pro-proliferative signaling pathways in patients with lower circFBXW7 levels was highlighted by gene expression profile analysis (Figure 1B). In line, circFBXW7 silencing *in vitro* suggested a tumor suppressor role of this circRNA in T-ALL, inciting deeper study of the mechanisms involved. The splicing factor Quaking (QKI), a tumor suppressor abnormally depleted in T-ALL<sup>6</sup>, has been recently shown to regulate circRNA biogenesis<sup>7</sup>. Thus, we investigated the link between QKI and the aberrant circRNA expression in T-ALL. Comprehensive bioinformatics analysis of RNA-seq data from patients, and circRNA profiling upon QKI knock-down in Jurkat cell line, concordantly indicated that QKI depletion strikingly affects the circRNA dysregulation in T-ALL and can drive circRNA-involving oncogenic axes (Figure 1C-D). In summary, our studies

of circRNAs are providing new biomarkers and revealing new mechanisms of malignant transformation in T-ALL.

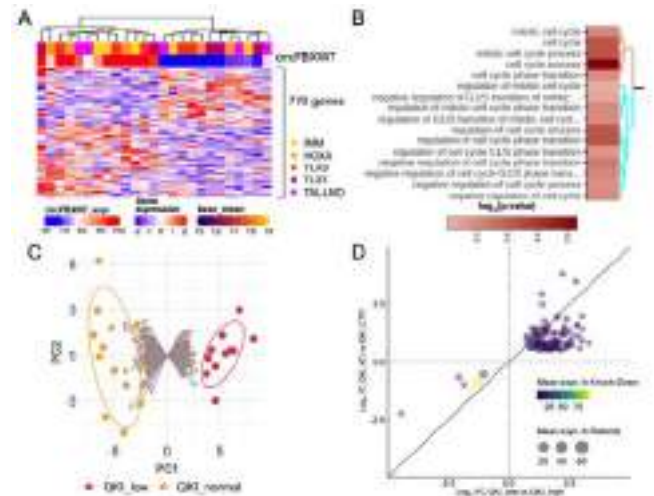

**Figure 1.** A) Expression heatmap of 170 genes with profiles significantly correlated with the circFBXW7 level in T-ALL patients. B) Enriched Gene Ontology terms among gene expression changes upon circFBXW7 silencing *in vitro* highlight the activation of Cell Cycle processes. C) Principal Component analysis of T-ALL patients using circRNA expression profiles separates two groups with low and normal QKI expression. D) Scatterplot of Log Fold Change of expression variation of circRNAs upon QKI knock-down in T-ALL patients (QKI<sub>low</sub> vs QKI<sub>high</sub>) and Jurkat cells (QKI<sub>KD</sub> vs QKI<sub>CTR</sub>).

**Figure 1.**

## References

1. Bonizzato, A., Gaffo, E., Te Kronnie, G. & Bortoluzzi, S. CircRNAs in hematopoiesis and hematological malignancies. *Blood Cancer J.* 6, e483 (2016).
2. Gaffo E, Boldrin E, Dal Molin A, Bresolin S, Bonizzato A, Trentin L, Frasson C, Debatin K-M, Meyer L, te Kronnie G, Bortoluzzi S. Circular RNA differential expression in blood cell populations and exploration of circRNA deregulation in pediatric acute lymphoblastic leukemia. *Sci. Rep.* 9, 14670 (2019).
3. Dal Molin A, Bresolin S, Gaffo E, Tretti C, Boldrin E, Meyer LH, Guglielmelli P, Vannucchi AM, Te Kronnie G, Bortoluzzi S. CircRNAs Are Here to Stay: A Perspective on the Recombinome. *Front. Genet.* 10, 88 (2019).
4. Gaffo, E., Buratin, A., Dal Molin, A. & Bortoluzzi, S. Sensitive, reliable and robust circRNA detection from RNA-seq with CirComPara2. *Brief. Bioinform.* 23, (2022).
5. Buratin A, Paganin M, Gaffo E, Dal Molin A, Roels J, Germano G, Siddi MT, Serafin V, De Decker M, Gachet S, Durinck K, Speleman F, Taghon T, Te Kronnie G, Van Vlierberghe P, Bortoluzzi S. Large-scale circular RNA deregulation in T-ALL: unlocking unique ectopic expression of molecular subtypes. *Blood Adv* 4, 5902–5914 (2020).
6. Van Vlierberghe P, van Grotel M, Tchinda J, Lee C, Beverloo HB, van der Spek PJ, Stubbs A, Cools J, Nagata K, Fornerod M, Buijs-Gladdines J, Horstmann M, van Wering ER, Soulier J, Pieters R, Meijerink JP. The recurrent SET-NUP214 fusion as a new HOXA activation mechanism in pediatric T-cell acute lymphoblastic leukemia. *Blood* 111, 4668–4680 (2008).
7. Conn SJ, Pillman KA, Toubia J, Conn VM, Salmandis M, Phillips CA, Roslan S, Schreiber AW, Gregory PA, Goodall GJ. The RNA binding protein quaking regulates formation of circRNAs. *Cell* 160, 1125–1134 (2015).

## MICRORNAS IN B CELL PRECURSOR ACUTE LYMPHOBLASTIC LEUKEMIA: STRICT COOPERATION WITH ONCOGENES AND TUMOR SUPPRESSORS

E. Boldrin<sup>1,2</sup>, E. Gaffo<sup>3</sup>, A. Niedermayer<sup>1</sup>, J.M. Boer<sup>4,5</sup>, M. Zimmermann<sup>6</sup>, D. Weichenhan<sup>7</sup>, R. Claus<sup>7,8</sup>, V. Münch<sup>1</sup>, Q. Sun<sup>1</sup>, S. Enzenmüller<sup>1</sup>, F. Seyfried<sup>1</sup>, S. Demir<sup>1</sup>, J. Zinngrebe<sup>1</sup>, G. Cario<sup>9</sup>, M. Schrappe<sup>9</sup>, M.L. Den Boer<sup>4,5</sup>, C. Plass<sup>7</sup>, K-M. Debatin<sup>1</sup>, G. Te Kronnie<sup>10</sup>, S. Bortoluzzi<sup>3,11</sup>, L.H. Meyer<sup>1</sup>

<sup>1</sup>Department of Pediatrics and Adolescent Medicine, Ulm University Medical Center, Ulm, Germany; <sup>2</sup>Department of Biology, University of Padua, Padua, Italy; <sup>3</sup>Department of Molecular Medicine, Padua University, Padua, Italy; <sup>4</sup>Princess Máxima Center for Pediatric Oncology, Utrecht, The Netherlands; <sup>5</sup>Onco Institute, Utrecht, The



Netherlands; <sup>6</sup>Department of Pediatric Hematology and Oncology, Medical School Hannover, Hannover, Germany; <sup>7</sup>Division of Cancer Epigenomics, German Cancer Research Center, Heidelberg, Germany. <sup>8</sup>Department of Hematology/Oncology, Augsburg University Medical Center, Augsburg, Germany; <sup>9</sup>Pediatric Hematology and Oncology, University Hospital Schleswig Holstein, Campus Kiel, Germany; <sup>10</sup>Department of Women's and Children's Health, Padua University, Padua, Italy; <sup>11</sup>Interdepartmental Research Center for Innovative Biotechnologies, Padua University, Padua, Italy

**Introduction:** B cell precursor acute lymphoblastic leukemia (BCP-ALL) is the most common malignancy of childhood. Despite cure rates up to 90%, relapse is still associated with poor prognosis, encouraging the research for critical pathways as prognostic markers and therapeutic targets. Frequent deletions in genes involved in cell cycle regulation indicate the importance of proliferative advantage for progression and prognosis of ALL. MicroRNAs (miRNAs) are critical regulators of gene expression, and their deregulation contributes to leukemia development and progression.

**Methods:** We analyzed the expression of miRNAs in pediatric BCP-ALL diagnostic and patient-derived xenograft (PDX) samples by small RNA sequencing and qRT-PCR. MiRNA function was assessed *in vivo* and *in vitro* by overexpression and inhibition in PDX using lentiviral transduction.

**Results:** Our group previously showed that rapid engraftment of leukemia cells transplanted into NOD/SCID mice is associated with poor patient outcome. Here, we identified methylation-dependent downregulation of the miR-497/195 cluster in PDX with rapid engraftment/poor outcome, suggesting a tumor suppressive role for miR-497/195. Lower event-free survival in ALL with low miR-497/195 expression was confirmed in two independent patient cohorts. Multivariate analysis indicated cluster expression as a prognostic marker independent from age, white blood cell count, and IKZF1<sup>plus</sup>. Overexpression of miR-497/195 in three different PDX samples inhibited *in vivo* leukemia development and prolonged recipient survival. Transcriptome analysis indicated miR-497/195-mediated inhibition of proliferation as a mechanism for decreased leukemia growth, which was validated in overexpression and inhibition studies *ex vivo*. MiR-497/195 regulation of its known targets CCND3 and CDK4 was partially responsible for this effect, suggesting CDK4 inhibition as a possible therapeutic strategy. Indeed, activity of the CDK inhibitor Palbociclib was altered by modulation of miR-497/195 expression. Importantly, CDK4 is also inhibited by CDKN2A/B, which are frequently deleted in BCP-ALL, further suggesting a critical role for this pathway in ALL. We found that low miR-497/195 expression together with deletion of *CDKN2A/B* was associated with early relapse and significantly lower relapse-free survival in ALL, indicating that concomitant loss of CDK inhibitors cooperates in promoting leukemia cell proliferation, leading to inferior patient outcome.

**Conclusion:** We showed that methylation-dependent inhibition of miR-497/195 mediates increased proliferation in BCP-ALL, promoting leukemia growth *in vivo* and *ex vivo* via upregulation of CDK4 and CCND3. Loss of tumor suppressive miR-497/195 leads to poor patient outcome combined with deletion of *CDKN2A/B*, pointing to deregulated cell cycle function both as prognostic factor and potential therapeutic target in BCP-ALL.

## References

- Boldrin, E., et al. (2021). MicroRNA-497/195 is tumor suppressive and cooperates with CDKN2A/B in pediatric acute lymphoblastic leukemia. *Blood* 138, 1953-1965.
- Carrasco Salas, P., et al. (2016). The role of CDKN2A/B deletions in pediatric acute lymphoblastic leukemia. *Pediatr Hematol Oncol* 33, 415-422.
- Meyer, L.H., et al. (2011). Early relapse in ALL is identified by time to leukemia in NOD/SCID mice and is characterized by a gene signature involving survival pathways. *Cancer cell* 19, 206-217.
- Schotte, D. (2011). MicroRNA characterize genetic diversity and drug resistance in pediatric acute lymphoblastic leukemia. *Haematologica* 96, 703-711.

Stanulla, M., et al. (2018). IKZF1plus Defines a New Minimal Residual Disease-Dependent Very-Poor Prognostic Profile in Pediatric B-Cell Precursor Acute Lymphoblastic Leukemia. *Journal of clinical oncology: official journal of the American Society of Clinical Oncology* 36, 1240-1249.

## NEW GENOMIC, TRANSCRIPTOMIC AND CELLULAR RISK FACTORS IN MULTIPLE MYELOMA

M. Martello

IRCCS Azienda Ospedaliero-Universitaria di Bologna - Istituto di Ematologia "Seragnoli" Dipartimento di Medicina Specialistica, Diagnostica e Sperimentale - Università di Bologna, Bologna, Italy

Therapeutic strategies in Multiple Myeloma (MM) have been adapted only to age and comorbidities for a long time. Given the currently available therapeutic and technologic arsenal, the time may have come to refine this adaptation, particularly for those patients defined high-risk who should benefit from the most intensive and efficient combinations already at diagnosis.<sup>1</sup> Similarly, risk stratification is crucial also in pre-neoplastic phases such as Smouldering Myeloma (SMM) for allowing comparison across trials.<sup>2</sup>

Risk assessment both in SMM and MM is currently under debates. Indeed, many clinical and biological (i.e. genomic, transcriptomic and cellular) prognostic factors may contribute to its definition, which should to be considered at three level: qualitative, quantitative and in time- dependent manner, therefore giving back a more dynamic risk profile assessment.<sup>4</sup>

High-risk MM accounts for around 25% of patients and is characterized by a short survival of 2–3 years, mostly due to drug resistance and early relapse.<sup>4</sup> Extramedullary disease and higher levels of circulating tumour cells have also been associated with shorter survival.<sup>5</sup> Other clinical factors affecting survival are response to therapies, early relapse after transplantation, and disease stage, as assessed by the International Staging System (ISS). To date, the most important prognostic factors are considered the genetic abnormalities in tumour plasma cells and the quality of the response to treatment.

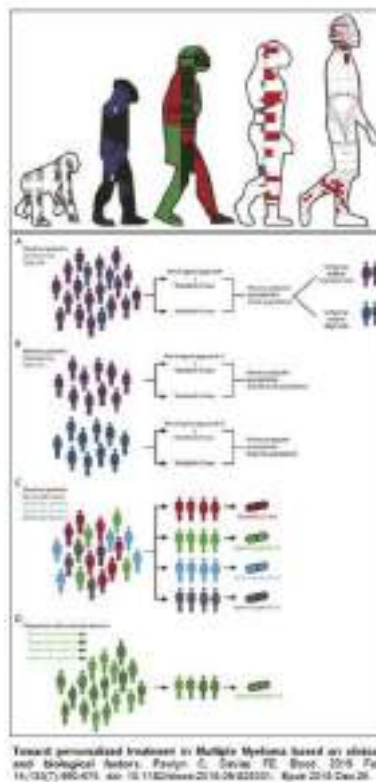

Figure 1.

During the last years the employment of next-generation sequencing techniques has heavily improved both the minimal residual disease assessment and the whole characterization of molecular abnormalities (e.g. copy number alterations, translocations, mutations).<sup>9</sup> Minimal residual disease represents the best prognosticator so far. However, several studies have highlighted that also MRD negative patients might experience disease progression.<sup>10</sup>

In these perspectives, it is crucial to determine all the prognostic factors, either molecular, cellular transcriptional and, obviously, clinical that best characterize patients' disease, aiming to an accurate risk stratification from diagnosis, and providing a re-assessment during disease evolution (from SMM to MM) and across disease course.

## References

1. Corre J, Munshi NC, Avet-Loiseau H. Risk factors in multiple myeloma: is it time for a revision? *Blood*. 2021;137(1):16-19.
2. Lonial S, Rajkumar SV, Mateos MV. Risk stratified management approaches for smouldering multiple myeloma: clinical research becomes clinical practice. *Lancet Haematol*. 2022 Feb;9(2):e162-e165. doi: 10.1016/S2352-3026(21)00335-5. PMID: 35114153.
3. Cazaubiel, T.; Mulas, O.; Montes, L.; Schavgoulidze, A.; Avet-Loiseau, H.; Corre, J.; Perrot, A. Risk and Response- Adapted Treatment in Multiple Myeloma. *Cancers* 2020, 12, 3497. <https://doi.org/10.3390/cancers12123497>
4. Costa LJ, Usmani SZ. Defining and Managing High-Risk Multiple Myeloma: Current Concepts. *J Natl Compr Canc Netw*. 2020 Dec 2;18(12):1730-1737. doi: 10.6004/jnccn.2020.7673. PMID: 33285523.
5. Usmani SZ, Heuck C, Mitchell A, et al. Extramedullary disease portends poor prognosis in multiple myeloma and is over-represented in high-risk disease even in the era of novel agents. *Haematologica*. 2012;97(11):1761-1767.
6. Palumbo A, Avet-Loiseau H, Oliva S, et al. Revised international staging system for multiple myeloma: a report from International Myeloma Working Group. *J Clin Oncol*. 2015;33(26):2863-2869.
7. Corre J, Perrot A, Caillot D, et al. del(17p) without TP53 mutation confers a poor prognosis in intensively treated newly diagnosed patients with multiple myeloma. *Blood*. 2021;137(9):1192-1195.
8. Martello M, Poletti A, Borsi E, et al. Clonal and subclonal TP53 molecular impairment is associated with prognosis and progression in multiple myeloma. *Blood Cancer J*. 2022 Jan 26;12(1):15. doi: 10.1038/s41408-022-00610-y. PMID: 35082295.
9. Pawlyn C, Davies FE. Toward personalized treatment in multiple myeloma based on molecular characteristics. *Blood*. 2019; 133: 660-675
10. Munshi NC, Avet-Loiseau H, Anderson KC, et al. A large meta-analysis establishes the role of MRD negativity in long-term survival outcomes in patients with multiple myeloma. *Blood Adv*. 2020;4(23):5988-5999.

## METABOLIC STRATEGIES OF MYELOID BLAST SURVIVAL

G. Simonetti<sup>1,2</sup>, C. Mengucci<sup>3,4</sup>, A. Padella<sup>1</sup>, E. Fonzi<sup>5</sup>, G. Picone<sup>3</sup>, C. Delpino<sup>6</sup>, J. Nanni<sup>7</sup>, R. De Tommaso<sup>2</sup>, E. Franchini<sup>1</sup>, C. Papayannidis<sup>7</sup>, G. Marconi<sup>8</sup>, M. Pazzaglia<sup>2</sup>, M. Perricone<sup>2</sup>, E. Scarpì<sup>5</sup>, M.C. Fontana<sup>1</sup>, S. Bruno<sup>2</sup>, M. Tebaldi<sup>5</sup>, A. Ferrari<sup>1</sup>, M.T. Bochicchio<sup>1</sup>, A. Ghelli Luserna Di Rorà<sup>1</sup>, M. Ghetti<sup>1</sup>, R. Napolitano<sup>1</sup>, A. Astolfi<sup>9</sup>, C. Baldazzi<sup>7</sup>, V. Guadagnuolo<sup>2</sup>, E. Ottaviani<sup>7</sup>, I. Iacobucci<sup>10</sup>, M. Cavo<sup>2,7</sup>, G. Castellani<sup>2</sup>, T. Haferlach<sup>11</sup>, D. Remondini<sup>4</sup>, F. Capozzi<sup>3</sup>, G. Martinelli<sup>12</sup>

<sup>1</sup>Biosciences Laboratory, IRCCS Istituto Romagnolo per lo Studio dei Tumori (IRST) "Dino Amadori", Meldola, FC, Italy; <sup>2</sup>Department of Experimental, Diagnostic and Specialty Medicine, University of Bologna, Bologna, Italy; <sup>3</sup>Department of Agricultural and Food Sciences, University of Bologna, Cesena, FC, Italy; <sup>4</sup>Department of Physics and Astronomy, University of Bologna, Bologna, Italy; <sup>5</sup>Unit of Biostatistics and Clinical Trials, IRCCS Istituto Romagnolo per lo Studio dei Tumori (IRST) "Dino Amadori", Meldola, FC, Italy; <sup>6</sup>Departamento de Ingeniería Química, Universidad Nacional del Sur, Bahía Blanca, Argentina; <sup>7</sup>IRCCS Azienda Ospedaliero-Universitaria di Bologna, Istituto di Ematologia "Seràgnoli", Bologna, Italy; <sup>8</sup>Hematology Unit, IRCCS Istituto Romagnolo per lo Studio dei Tumori (IRST) "Dino Amadori", Meldola, FC, Italy; <sup>9</sup> Department of Biomedical and Specialty Surgical Sciences, University of Ferrara, Ferrara, Italy; <sup>10</sup>Department of Pathology, St. Jude Children's Research Hospital, Memphis, TN, USA; <sup>11</sup>MLL Munich Leukemia Laboratory, Munich, Germany; <sup>12</sup>Scientific Directorate, IRCCS Istituto Romagnolo per lo Studio dei Tumori (IRST) "Dino Amadori", Meldola, FC, Italy

Personalized medicine in acute myeloid leukemia (AML) is restricted to few patients with targetable genomic lesions.<sup>1,2</sup> However, this approach does not account for leukemia complexity, which encompasses genomic, epigenetic, transcriptomic, microenvironmental and metabolic features.<sup>3</sup> In particular, the metabolome is the results of these interactions and provides a sensitive measure of the AML phenotype. Our work aims to provide a comprehensive characterization of metabolic changes occurring in AML and map connections between their metabolic and genomic profiles. We analyzed serum and urine metabolomic profiles of 119 AML patients and 145 healthy controls by nuclear magnetic resonance and intracellular metabolites of 50 bone marrow blast and 42 control samples by mass spectrometry. Genomic data were obtained by WES or targeted NGS and integrated with DNA- and RNA-seq data from the TCGA-LAML and Beat AML datasets. Leukemia stem-progenitor cells undergo metabolic switches. We observed decreased levels of intermediates of the of TCA cycle, D-Arginine, D-ornithine and linoleic acid metabolism.<sup>4</sup> Moreover, integrated intracellular and biofluid data highlighted changes in the metabolism of polyamine, purine, polyunsaturated fatty acids and keton bodies in AML. At genomic level, 66% of patients (436/658) carried somatic mutations of metabolic enzymes and regulators, mainly targeting the lipid, carbohydrate and bioenergetic pathways. Damaging mutations (56% overall) in the bioenergetic, nucleotide and oxidation pathways were associated with chromatin/spliceosome-mutated (mut), *TP53*-mut/aneuploid and *NPM1*-mut AML, respectively (p=.008, p=.040, p=.024). Metabolic reprogramming also varies according to the molecular background. The intracellular metabolome distinguished three AML clusters, showing enrichment of the above mentioned genomic subgroups (p=.023). Among *NPM1*-mut AML, cases with increased serum choline+trimethylamine-N-oxide and leucine levels were characterized by higher mutation load (p<.001), mutations in cohesin/DDR genes (p=.024), transcriptomic signatures of reduced inflammation and better *ex vivo* response to EGFR and MET inhibition. *In silico* prediction of transcriptomic-driven metabolic perturbations on a genome-scale metabolic network suggested alterations in NAD and purine metabolism in this subgroup. The *TP53*-enriched cluster had low serum levels of threonine and glucose, with reduced lactate excretion compared with wildtype cases. Moreover, upregulated genes in complex karyotype AML were involved in inositol phosphate metabolism, C20 prostanoid and heme biosynthesis, glycolysis, urea cycle. Overall, our data show that AML is characterized by genomic-driven and functional metabolic alterations. Ketone bodies represent a novel exploitable vulnerability. The integration of genomic and metabolic profiles suggests specific metabolic dependencies to be therapeutically validated in complex karyotype and *NPM1*-mut AML subgroups.

## References

1. Burd, A. et al. Precision medicine treatment in acute myeloid leukemia using prospective genomic profiling: feasibility and preliminary efficacy of the Beat AML Master Trial. *Nat. Med.* (2020) doi:10.1038/s41591-020-1089-8.
2. Papaemmanuil, E. et al. Genomic Classification and Prognosis in Acute Myeloid Leukemia. *N. Engl. J. Med.* (2016) doi:10.1056/NEJMoa1516192.
3. Panuzzo, C., Jovanovski, A., Shahzad Ali, M., Cilloni, D. & Pergolizzi, B. Revealing the Mysteries of Acute Myeloid Leukemia: From Quantitative PCR through Next-Generation Sequencing and Systemic Metabolomic Profiling. *J. Clin. Med.* 11, 483–495 (2022).
4. Simonetti, G. et al. Integrated genomic-metabolic classification of acute myeloid leukemia defines a subgroup with NPM1 and cohesin/DNA damage mutations. *Leukemia* (2021) doi:10.1038/s41375-021-01318-x.
5. Presti, C. Lo, Fauvelle, F., Jacob, M. C., Mondet, J. & Mossuz, P. The metabolic reprogramming in acute myeloid leukemia patients depends on their genotype and is a prognostic marker. *Blood Adv.* (2021) doi:10.1182/blood-advances.2020002981.

## NEW FRONTIERS IN MEASURABLE RESIDUAL DISEASE DETECTION

F. Buccisano, R. Palmieri

*Department of Biomedicine and Prevention, University Tor Vergata, Rome, Italy*

Measurable residual disease (MRD) has been widely recognized as a surrogate marker of the quality of response in patients with Acute Myeloid Leukemia (AML).<sup>1</sup> Due to the heterogeneity of AML, a variety of techniques for MRD determination have been developed and progressively introduced into daily clinical practice. However, regardless of which technique better suits the specific case, the reliability of an MRD assay can be guaranteed only when strict requirements of harmonization and reproducibility are met. Due to the increasing number of studies adopting MRD as a treatment driver,<sup>2,3</sup> the European LeukemiaNet (ELN) MRD Working Party recently released an update of the 2018 guidelines.<sup>4,5</sup> Beside a better definition of several technical aspects,<sup>6</sup> the updated recommendations reiterated the role of MRD status as a surrogate biomarker of response and its possible influence on the decision-making process of post-remission treatment selection and new drug development and approval. As a future perspective, the authors suggest implementing MRD assessment through Next-Generation Sequencing (NGS) to refine prognosis in combination with Multiparametric Flow Cytometry (MFC) analysis, although, to date, there are still insufficient data to recommend NGS for MRD monitoring as a stand-alone technique. The role of MRD in the context of less intensive therapies, particularly after the approval of hypomethylating agents and venetoclax combinations, deserves further exploration. The possible role of Azacitidine/Venetoclax combination in increasing the proportion of MRD negative responses has been recently investigated in a post-hoc analysis of the VIALE-A trial.<sup>7</sup> Out of 164 evaluable patients, almost half (42%) achieved MRD negativity, defined as <0.1% residual leukemic cells as measured by MFC. MRD negative patients showed significant longer overall (OS) and disease-free survival (DFS) as compared to the MRD positive counterpart. Although further studies are needed to confirm these findings, the outcomes of this analysis provide evidence on the feasibility and prognostic relevance of MRD monitoring among patients treated with lower-intensity approaches. The prognostic impact of MRD status was also investigated in the setting of patients undergoing post-remission maintenance therapy. In the QUAZAR trial,<sup>8</sup> oral Azacitidine prolonged OS and DFS in patients aged  $\geq 55$  years with AML in first remission after intensive chemotherapy who were not candidates for further intensive therapies. However, as a higher rate of MRD positive to negative conversion rate (37% vs 19%) was observed in the Azacitidine arm, maintenance therapy could be effective not only in “keeping” but also “influencing” MRD status, thus representing an additional not-necessarily intensive (yet effective and remission-oriented) treatment option in AML. These technical and clinical evidences about MRD will be further expanded in the presentation.

### References

- Short NJ, Zhou S, Fu C, et al. Association of Measurable Residual Disease With Survival Outcomes in Patients With Acute Myeloid Leukemia. *JAMA Oncol* [Epub ahead of print].
- Venditti A, Piciocchi A, Candoni A, et al. GIMEMA AML1310 trial of risk-adapted, MRD-directed therapy for young adults with newly diagnosed acute myeloid leukemia. *Blood*;134(12):.
- Löwenberg B, Pabst T, Maertens J, et al. Addition of lenalidomide to intensive treatment in younger and middle-aged adults with newly diagnosed AML: the HOVON-SAKK-132 trial. *Blood Adv* 2021;5(4):1110–1121.
- Schuurhuis GJ, Heuser M, Freeman S, et al. Minimal/measurable residual disease in AML: consensus document from ELN MRD Working Party. *Blood* 2018;blood-2017-09-801498.
- Heuser M, Freeman SD, Ossenkoppele GJ, et al. 2021 Update on MRD in acute myeloid leukemia: a consensus document from the European LeukemiaNet MRD Working Party. *Blood* 2021;138(26):2753–2767.
- Tettero JM, Freeman S, Buecklein V, et al. Technical Aspects of Flow Cytometry-based Measurable Residual Disease Quantification in Acute Myeloid Leukemia: Experience of the European LeukemiaNet MRD Working Party. *HemaSphere* 2021;6(1):E676.

- Pratz KW, Jonas BA, Pullarkat V, et al. Measurable Residual Disease Response and Prognosis in Treatment-Naïve Acute Myeloid Leukemia With Venetoclax and Azacitidine. *J Clin Oncol* 2021;1–12.

## TO START OR NOT TO START THIS IS THE QUESTION: COMPARING OPINIONS ON THE TREATMENT OF EARLY MYELOFIBROSIS - FRONT OF YES

F. Palandri, D. Bartoletti, G. Auteri

*IRCCS Azienda Ospedaliero-Universitaria di Bologna, Istituto di Ematologia “L. and A. Seràgnoli”, Italy*

With the advent of targeted therapies, such as the Janus kinase inhibitors, many patients have experienced substantial clinical benefits, including reduction in splenomegaly and symptoms and, in some instances, improvement or stabilization of bone marrow fibrosis and reduction of JAK2 V617F allele burden. These observations raise the possibility of patients in earlier phases of the disease also benefiting from treatment with targeted therapies. To date, no specific guideline has been developed—on, for example, the basis of adverse prognostic features—to allow identification of patients with early-stage MF who have inadequately controlled disease or who should receive a more personalized or preemptive therapeutic approach. Nonetheless, early-stage MF may have a significant burden of the disease. Indeed, over 40% of IPSS lower-risk patients carry moderate to severe systemic symptoms<sup>1</sup>, and an increased total symptom score was found to correlate with larger splenomegaly. Finally, around 40% of IPSS lower-risk patients are at High Molecular Risk, which is associated with worse prognosis<sup>2,3</sup>. Patients with symptomatic disease and/or HMR mutations might deserve earlier initiation of ruxolitinib. Also, a more advanced disease and a delay in treatment start may reduce ruxolitinib efficacy. In an Italian retrospective study, spleen/symptoms responses are lower if time interval between MF diagnosis and ruxolitinib start > 2 years, if larger splenomegaly/higher TSS, if transfusion dependency/lower platelet count and in int-2/high IPSS risk patients. The use of lower ruxolitinib doses may also result in reduced efficacy<sup>4</sup>. In a pooled analysis data of the COMFORT-I and COMFORT-II studies, the risk of death was reduced by 30% in patients randomized to ruxolitinib compared with that in patients in the control group (median OS: ruxolitinib, 5.3 years; control, 3.8 years). The survival advantage in the crossover group was less than the ruxolitinib-randomized group, suggesting greater clinical benefit with earlier intervention<sup>5</sup>. A recent analysis of the COMFORT studies suggests that earlier (<12 months) ruxolitinib initiation for intermediate-2 and high-risk MF is associated with improved clinical outcomes, including fewer cytopenia events, durable SVR, symptom burden, and OS. On multivariable analysis, shorter disease duration before ruxolitinib initiation was significantly associated with greater spleen volume reduction<sup>6</sup>. Although “watch and wait” remains a common treatment approach for newly diagnosed patients, these data suggest that patients with MF may benefit from earlier intervention.

Additional studies to further evaluate the impact of early intervention are warranted.

### References

- Mesa R, Miller CB, Thyne M, Mangan J, Goldberger S, Fazal S, et al. Myeloproliferative neoplasms (MPNs) have a significant impact on patients' overall health and productivity: the MPN Landmark survey. *BMC cancer*. 2016 Feb 27;16:167.
- Guglielmelli P, Biamonte F, Rotunno G, Artusi V, Artuso L, Bernardis I, et al. Impact of mutational status on outcomes in myelofibrosis patients treated with ruxolitinib in the COMFORT-II study. *Blood*. 2014 Apr 3;123(14):2157-60.
- Vannucchi AM, Lasho TL, Guglielmelli P, Biamonte F, Pardanani A, Pereira A, et al. Mutations and prognosis in primary myelofibrosis. *Leukemia*. 2013 Sep;27(9):1861-9.
- Palandri F, Palumbo GA, Bonifacio M, Tiribelli M, Benevolo G, Martino B, et al. Baseline factors associated with response to ruxolitinib: an independent study on 408 patients with myelofibrosis. *Oncotarget*. 2017 Oct 3;8(45):79073-86.
- Verstovsek S, Gotlib J, Mesa RA, Vannucchi AM, Kiladjan JJ, Cervantes F, et al. Long-term survival in patients treated with ruxolitinib for myelofibrosis:

- COMFORT-I and -II pooled analyses. *Journal of hematology & oncology*. 2017 Sep 29;10(1):156.
- Verstovsek S, Kiladjan J, Vannucchi AM, Mesa RA, Scherber R, Hamer-Maansson JE, et al. Does Early Intervention in Myelofibrosis Impact Outcomes? a Pooled Analysis of the Comfort I and II Studies. *American Society of Hematology. ASH 2021*, abstract 1505.
  - Roboz GJ, Ravandi F, Wei AH, et al. Oral azacitidine prolongs survival of patients with AML in remission independent of measurable residual disease status. *Blood* [Epub ahead of print].

## DRIVERS OF PROGRESSION IN MPNS

R. Manfredini

Centre for Regenerative Medicine "S. Ferrari", Dept. of Life Sciences, University of Modena & Reggio Emilia, Italy

Philadelphia-negative myeloproliferative neoplasms (MPNs) are a class of clonal hematological disorders characterized by the expansion of terminally differentiated myeloid cells. Polycythemia vera (PV), essential thrombocythemia (ET) and primary myelofibrosis (PMF) represents the main clinical entities included in this group of myeloid neoplasms according to the 2016 WHO classification and arise from the acquisition of somatic mutations in hematopoietic stem/progenitor cells.<sup>1</sup> The vast majority of MPN patients harbor one of the three "driver" mutations affecting *JAK2*, *MPL* or *CALR* genes that are considered responsible for the development of the myeloproliferative phenotype.<sup>2</sup> Nevertheless, MPNs are chronic disorders characterized by increased risk of progression to secondary acute myeloid leukemia (sAML).<sup>3</sup> Leukemic transformation is diagnosed based on the percentage of blast count in peripheral blood and bone marrow, the blast phase is defined by the presence of blasts more than 20% and is typically preceded by an accelerated phase (blast count 10-9%).<sup>4</sup> sAML have a particular dismal prognosis and presents with clinical features different from *de novo* AML.<sup>5</sup> The molecular landscape clearly distinguishes sAML from *de novo* AML since it is rarely associated with the presence of *FLT3* or *NPM1* mutations while the most frequent hits involve TP53, epigenetic regulators (e.g. *ASXL1*, *IDH1/2*, *EZH2* and *TET2*) or spliceosome modulators (e.g. *SRSF2*) (Figure 1).<sup>6</sup>

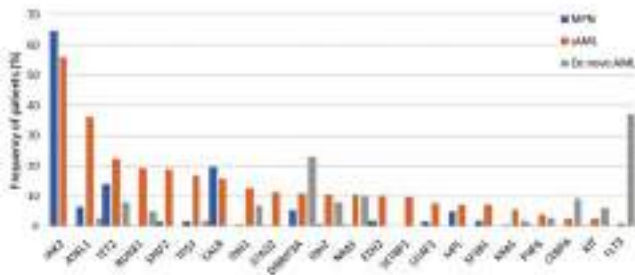

**Figure 1. Mutational landscape in MPNs, post-MPN sAML and *de novo* AML.** Bars represent the frequency of gene mutations in MPN (adapted from Grinfeld et al., *New England Journal of Medicine* 2018), post-MPN sAML (McNamara et al., *Blood Advances* 2018 and Lasho et al., *Blood Advances* 2018) and *de novo* AML (Patel et al., *New England Journal of Medicine* 2012).

Several clinical and molecular features have been associated to an increased risk of disease progression in MPNs contributing to the refinement of contemporary prognostic models.<sup>7</sup> Cytogenetic abnormalities and specific gene mutations turned out as the most important risk factors for disease progression leading to the development of a refined genomic based classification scheme for MPNs highlighting that the presence of TP53 deletions or mutations are associated to the highest risk of transformation.<sup>3</sup> Furthermore, it was previously demonstrated that harboring at least one high molecular risk (HMR) mutation (i.e. those affecting *ASXL1*, *EZH2*, *IDH1/2*, *SRSF2* and *U2AF1*) represents a risk factor for leukemic transformation.<sup>8</sup> The prognostic relevance of "non-driver" mutations was strengthened by clonality studies that highlighted their

pathogenic role in sAML development. Indeed, single cell genomics provided the opportunity to clarify clonal architecture in MPNs with an unprecedented resolution level and allowed a precise description of the clonal dynamics and molecular events that accompany the process of leukemic transformation.<sup>9,10</sup> These studies provide novel and accurate information about clonal architecture and mutation acquisition order, demonstrating that clonal heterogeneity dramatically increases during disease evolution; nevertheless, they also demonstrated that, in most cases, clones driving MPNs progression are already detectable during chronic phase thus providing a new layer of potentially useful information that might influence clinical decision making.

## References

- Arber DA, Orazi A, Hasserjian R, et al. The 2016 revision to the World Health Organization classification of myeloid neoplasms and acute leukemia. *Blood*. 2016;127(20):2391-2405. doi:10.1182/blood-2016-03-643544
- Tefferi A. Primary myelofibrosis: 2021 update on diagnosis, risk-stratification and management. *Am J Hematol*. 2021;96(1):145-162. doi:10.1002/ajh.26050
- Grinfeld J, Nangalia J, Baxter EJ, et al. Classification and Personalized Prognosis in Myeloproliferative Neoplasms. *N Engl J Med*. 2018;379(15):1416-1430. doi:10.1056/NEJMoa1716614
- Mudireddy M, Gangat N, Hanson CA, Ketterling RP, Pardanani A, Tefferi A. Validation of the WHO defined 20% circulating blasts threshold for diagnosis of leukemic transformation in primary myelofibrosis. *Blood Cancer J*. 2018;8(6):57. Published 2018 Jun 11. doi:10.1038/s41408-018-0095-2
- Yogarajah M, Tefferi A. Leukemic Transformation in Myeloproliferative Neoplasms: A Literature Review on Risk, Characteristics, and Outcome. *Mayo Clin Proc*. 2017;92(7):1118-1128. doi:10.1016/j.mayocp.2017.05.010
- Dunbar AJ, Rampal RK, Levine R. Leukemia secondary to myeloproliferative neoplasms. *Blood*. 2020;136(1):61-70. doi:10.1182/blood.2019000943
- Tefferi A, Guglielmelli P, Lasho TL, et al. MIPSS70+ Version 2.0: Mutation and Karyotype-Enhanced International Prognostic Scoring System for Primary Myelofibrosis. *J Clin Oncol*. 2018;36(17):1769-1770. doi:10.1200/JCO.2018.78.9867
- Vannucchi AM, Lasho TL, Guglielmelli P, et al. Mutations and prognosis in primary myelofibrosis. *Leukemia*. 2013;27(9):1861-1869. doi:10.1038/leu.2013.119
- Parenti S, Rontautoli S, Carretta C, et al. Mutated clones driving leukemic transformation are already detectable at the single-cell level in CD34-positive cells in the chronic phase of primary myelofibrosis. *NPJ Precis Oncol*. 2021;5(1):4. Published 2021 Feb 4. doi:10.1038/s41698-021-00144-9
- Mylonas E, Yoshida K, Frick M, et al. Single-cell analysis based dissection of clonality in myelofibrosis. *Nat Commun*. 2020;11(1):73. Published 2020 Jan 7. doi:10.1038/s41467-019-13892-x

## SARS-COV2 COAGULOPATHY: AN INTRICATED PUZZLE

M. Napolitano, S. Siragusa

Department of Health Promotion, Mother and Child Care, Internal Medicine and Medical Specialties (PROMISE), University of Palermo, Italy

Severe COVID-19 leads to severe respiratory insufficiency, the disease course is often complicated by thromboembolic events and, on a laboratory perspective, it is characterised by an increase in D-dimer levels, even without thrombosis of the large vessels. COVID-19-associated coagulopathy has been evaluated by several clinical trials, focused on antithrombotic strategies. We here describe available evidences on COVID-19-associated hypercoagulability. The occurrence of thromboembolic complications in patients affected by COVID-19 is particularly high for subjects admitted to intensive care units, even if it remains higher than reported for other infections (i.e. secondary to influenza virus) also in medical units. Studies performed on autopsy of patients died from COVID-19 have shown pulmonary macroemboli, endothelial damage, microemboli, and obstruction of alveolar capillaries. Thrombotic complications are secondary to an imbalance of the coagulation system with a procoagulant phenotype, mirrored by increased D-dimer, increased viscoelastic blood properties and enhanced platelet activation. Increased D-dimer plasma levels have been associated with a poor prognosis. Platelet counts and prothrombin time are usually normal in asymptomatic subjects with Sars-Cov2 infection but they tend to become

abnormal when clinical conditions deteriorate. COVID-19 coagulopathy has been classified into 3 stages: Stage 1, involving asymptomatic patients with mild systemic coagulopathy; stage 2 with respiratory symptoms requiring oxygen supply, evolving pulmonary inflammation and coagulopathy with thrombosis of the small vessels; stage 3 with severe respiratory distress requiring mechanical ventilatory support, massive inflammatory reaction and development of overt coagulopathy. This last stage is characterized by high D-dimer and fibrinogen levels, prolonged prothrombin time, reduced platelet counts, and a very high incidence of venous thromboembolism. NLRP3 inflammasome has been involved in the pathogenesis of respiratory disease, the cytokine storm induced by COVID-19, leads to endothelial dysfunction with high levels of D-dimer, thrombin and fibrin degradation products, thrombocytopenia and prolonged clotting times. These abnormalities, on a clinical perspective, induce hypoxia, thrombosis and microvascular occlusion, in addition to thrombosis of central vein catheters and ischemic events. COVID-19 induces a high prothrombotic phenotype, thus low-molecular-weight heparin thromboprophylaxis should be administered to all in-hospital patients with COVID-19. The most appropriate anti-thrombotic prophylaxis in out-patients still needs to be defined. Prophylaxis with intermediate dose low-molecular-weight heparin is recommended by some guidelines for critically ill patients.

## References

- Levi M, Thachil J, Iba T, Levy JH. Coagulation abnormalities and thrombosis in patients with COVID-19. *Lancet Haematol.* 2020;7:e438–e440
- Middeldorp S, Coppens M, van Haaps TF. Incidence of venous thromboembolism in hospitalized patients with COVID-19. *J Thromb Haemost.* 2020;18:1995–2002
- Boonyawat K, Chantrathammachart P, Numthavaj P. Incidence of thromboembolism in patients with COVID-19: a systematic review and meta-analysis. *Thromb J.* 2020;18:34.
- Iba T, Levy JH, Connors JM, Warkentin TE, Thachil J, Levi M. The unique characteristics of COVID-19 coagulopathy. *Crit Care.* 2020;24:360.
- Lucchesi A, Silimbani P, Musuraca G, Cerchione C, Martinelli G, Di Carlo P, Napolitano M. Clinical and biological data on the use of hydroxychloroquine against SARS-CoV-2 could support the role of the NLRP3 inflammasome in the pathogenesis of respiratory disease. *J Med Virol.* 2021 Jan;93(1):124-126. doi: 10.1002/jmv.26217. Epub 2020 Jul 6. PMID: 32579244; PMCID: PMC7361389.

## TERAPIA CHEMO-FREE NELLA LEUCEMIA LINFOBLASTICA ACUTA 3000 INCLUSI 12

S. Chiaretti

*Department of Translational and Precision Medicine 'Sapienza' University of Rome, Italy*

Acute lymphoblastic leukemia (ALL), the most common cancer in childhood represents a success story in oncohematology. Indeed, in the mid-sixties the disease was fatal in children as well adults. With the introduction of intensive polichemotherapeutic regimens, the survival of childhood ALL is reaching 80%; in adults, the outcome is still inferior, though is constantly improving, approaching almost 50%, thus meaning that that there is large space for improvement.

Furthermore, in the last decades, the use of “omics” technologies has permitted to identify specific lesions that might drive targeted treatments, thus sparing non leukemic cells. Ultimately, the use of monoclonal antibodies, either nude or conjugates, among which blinatumomab and inotuzumab have entered predominantly the clinical practice, have represented another step forward in the treatment.

With these premises in mind, the question on the applicability of a chemo-free approach for ALL is more and more fascinating.

The illuminating example in this respect is represented by Philadelphia + ALL (Ph+ ALL): until the early 2000, this subgroup was considered as the subset with the worst prognosis; later, the introduction of tyrosine kinase inhibitors (TKIs), alone or in combinations with chemotherapy and allogeneic transplant, has permitted to achieve long

term survival rates in the range of 50%; finally, the sequential/concomitant use of blinatumomab has established short-term survival rates reaching 90% or more, thus is proving that when a causal target is identified, an ad hoc targeting is not only feasible but indeed successful.

Other possible examples in this respect are represented by so called Ph-like ALL, characterized by a transcriptomic similar to that of Ph+ ALL but lacking the t(9;22) where the use a TKI is proving effective in controlling the disease, in conjunction with a chemotherapeutic backbone. Large efforts are ongoing to identify genetic lesions for which a targeted approach is feasible. Among the most recurrent genetic lesions, it must be recalled the JAK/STAT pathway, the RAS pathway, and in T-lineage ALL, the NOTCH pathway. Furthermore, the BCL-2 pathway, which is providing some results in the relapsed/refractory setting, might be in principle be used in the majority of ALL subsets.

In general, to make the principle of chemo-free approach feasible, two conditions must be met: first, the targeted lesion must be a driver mutation (i.e. causal of the disease); second, the drug must be promptly available, which is often not the case. Thus, in the era of personalized and precision medicine, it is mandatory to seek for drug accessibility. Efforts should be made not only for target discovery, but also to reduce the time between target identification and drug availability.

## References

- Pui CH, Relling MV, Downing JR. Acute lymphoblastic leukemia. *N Engl J Med.* 2004 Apr 8;350(15):1535-48. doi: 10.1056/NEJMra023001. PMID: 15071128.
- Roberts KG, Gu Z, Payne-Turner D, et al. High Frequency and Poor Outcome of Philadelphia Chromosome-Like Acute Lymphoblastic Leukemia in Adults. *J Clin Oncol.* 2017 Feb;35(4):394-401. doi: 10.1200/JCO.2016.69.0073.
- Foà R, Bassan R, Vitale A, et al. Dasatinib-Blinatumomab for Ph-Positive Acute Lymphoblastic Leukemia in Adults. *N Engl J Med.* 2020 Oct 22;383(17):1613-1623.
- Chiaretti S, Messina M, Della Starza I, et al. Philadelphia-like acute lymphoblastic leukemia is associated with minimal residual disease persistence and poor outcome. First report of the minimal residual disease-oriented GIMEMA LAL1913. *Haematologica.* 2021 Jun 1;106(6):1559-1568.
- Martinelli G, Papayannidis C, Piciocchi A, et al. INCB84344-201: Ponatinib and steroids in frontline therapy of unfit patients with Ph+ acute lymphoblastic leukemia. *Blood Adv.* 2021 Oct 14;bloodadvances.2021004821.
- Short NJ, Kantarjian H, Konopleva MY, et al. Combination of ponatinib and blinatumomab in Philadelphia chromosome-positive acute lymphoblastic leukemia: Early results from a phase II study. Presented at: 2021 ASCO Annual Meeting; June 4-8, 2021.
- Pullarkat VA, Lacayo NJ, Jabbour E, et al. Venetoclax and Navitoclax in Combination with Chemotherapy in Patients with Relapsed or Refractory Acute Lymphoblastic Leukemia and Lymphoblastic Lymphoma. *Cancer Discov.* 2021 Jun;11(6):1440-1453.
- Bourquin JP. A precision medicine approach to haematological malignancies. *Lancet Haematol.* 2017 Dec;4(12):e567-e568.

## GIMEMA LECTURE: INDEPENDENT CLINICAL RESEARCH AS AN ESSENTIAL PLATFORM FOR PROVIDING QUALITY CARE TO HEMATOLOGICAL PATIENTS IN THE NHS

A. Piciocchi<sup>1</sup>, M. Messina<sup>1</sup>, P. Fazi<sup>1</sup>, M. Vignetti<sup>1,2</sup>

<sup>1</sup>GIMEMA Foundation, Rome, Italy; <sup>2</sup>Department of Translational and Precision Medicine, Hematology, Sapienza University of Rome, Rome, Italy

1982 marked the birth of GIMEMA (Gruppo Italiano Malattie Ematologiche dell'Adulto) group. It was founded by a small number of Italian hematology centers, who realized that they could achieve scientifically significant results only by joining forces and comparing case histories. It was the beginning of a path that led to dramatic successes. Today, after 40 years, GIMEMA is a well known non-profit research Foundation which operates, through its various bodies, to conduct research into leukemia and other blood diseases. Non-profit trials aim to achieve, on the one hand, a clear benefit for patients in the sense of offering additional opportunities for therapeutic and health perspectives, and, on the other hand, an advantageous cost-effectiveness of the health system while opti-

mizing the quality of care services. Over the years, the scientific-methodological approach of the GIMEMA Foundation pointed to improving patient outcomes study after study, using the results of the former study as the starting hypothesis for the next trial. The advantage of doing this in a non-profit setting has allowed us to carry out studies in which different drugs, from different companies, could be used together and compared, modifying treatment schemes without commercial interests. The most successful examples, recognized worldwide, of this approach are represented by the results obtained in the acute promyelocytic leukemia and in the Philadelphia positive leukemias (Acute Lymphoblastic Leukemia and Chronic Myeloid Leukemia). Indeed survival rates at 2-years for acute promyelocytic leukemia and Acute Lymphoblastic Leukemia patients increased from 10% to 99% and from 30% to 90%, respectively. Lastly in Chronic Myeloid Leukemia with the introduction of new therapies, 10-year survival increased from 20% to 80%. The oral presentation will focus on the above mentioned experiences. In conclusion, GIMEMA trials are meant to offer a therapeutic option to all patients affected by hematological disorders, particularly leukemias, representing an essential platform to provide quality care to hematology patients and an advantageous cost-effectiveness for the National Health System. An added value is the promotion of translational research, ancillary to all GIMEMA protocols, that is pivotal in the era of the precision medicine and allows to carry out the most advanced innovative trials.

## ROLE OF THE MICROENVIRONMENT IN THE PATHOGENESIS OF MYELODYSPLASTIC SYNDROMES

G. Falconi<sup>1</sup>, E. Galossi<sup>1</sup>, M.T. Voso<sup>1,2</sup>

<sup>1</sup>Department of Biomedicine and Prevention, University of Rome Tor Vergata, Rome, Italy; <sup>2</sup>Fondazione Santa Lucia, Laboratorio di Neuro-Oncoematologia, Roma, Italy

By definition, myelodysplastic syndromes (MDS) are considered clonal myeloid neoplasms of the hematopoietic progenitor or stem cells (HPSC), in which disease initiation and progression are mostly driven by hematopoietic cell-intrinsic genetic events.

During the past 20 years, the bone marrow (BM) microenvironment, has been shown to exhibit a potentially permissive or causative role, challenging the belief that hematopoietic cell disorder is solely an element of the initiation and progression of MDS. In particular, a large number of studies have shown that MDS are associated with an abnormal BM microenvironment, with mesenchymal stem cells (MSC) as a major component of this disrupted architecture.<sup>1-2</sup> BM-MSCs, physiologically, support HSC maintenance, self-renewal, and differentiation, through hematopoietic-stromal interactions and production and secretion of cytokines. In addition, BM-MSCs display immune-regulatory functions, by maintaining the stability of the BM immune microenvironment and reducing the damage caused to HSC by stress stimuli.

The first experimental evidence supporting the crucial role of BM-MSCs in the initiation of MDS comes from *in vivo* models, where endonuclease Dicer1 deletion restricted to the stromal compartment is able to induce a MDS-like syndrome evolving into overt leukemia in mice.<sup>3</sup>

From a functional point of view, BM-MSCs isolated from patients with MDS exhibit decreased proliferative and clonogenic capacity, altered morphology, increased senescence, defective osteogenic differentiation potential, impaired immune-regulatory properties, and reduced ability to support HSC growth and differentiation, as compared to normal MSC.<sup>1,4-6</sup> Moreover, several studies have reported the occurrence of non-clonal chromosomal aberrations in BM-MSCs isolated from patients with MDS, mainly numerical, which only very rarely correspond to the cytogenetic markers observed in the leukemic clone of the same individuals.<sup>7</sup>

Currently, although the understanding of the genetics and gene expression characteristics associated with *ex vivo*-expanded MDS-MSCs remains limited and not always congruent between different paper, the

study of functional changes in MDS-MSCs is increasingly attracting the attention of researchers for its future potential in prognostic and therapeutic terms. Restoring MDS-MSCs function as an option for MDS treatment has gradually advanced from its theoretical basis to the translational research level. Several recent papers have shown that the *in vitro* treatment of MDS-MSCs with the TGF-beta pathway inhibitor luspatercept or the demethylating agent 5-Azacytidine may reset their normal features inducing an increase of their clonogenic and proliferation capacity.<sup>8-9</sup> Moreover, improving MSC function may delay disease progression and enhance cytopenia of MDS as demonstrated after transplantation of NHD13 mouse hematopoietic cells into normal mouse BM.<sup>10</sup> Finally, all changes observed in MDS-MSCs may provide potential targets to be combined with the standard therapy against HSC and so lead to a new treatment strategy for MDS patients.

## References

- Geyh S, Oz S, Cadeddu RP, et al. Insufficient stromal support in MDS results from molecular and functional deficits of mesenchymal stromal cells. *Leukemia*. 2013;27(9):1841-51.
- Aanei CM, Flandrin P, Eloae FZ, et al. Intrinsic growth deficiencies of mesenchymal stromal cells in myelodysplastic syndromes. *Stem Cells Dev*. 2012;21(10):1604-15.
- Raaijmakers MH, Mukherjee S, Guo S, et al. Bone progenitor dysfunction induces myelodysplasia and secondary leukaemia. *Nature*. 2010;464(7290):852-7.
- Poon Z, Dighe N, Venkatesan SS, et al. Bone marrow MSCs in MDS: contribution towards dysfunctional hematopoiesis and potential targets for disease response to hypomethylating therapy. *Leukemia*. 2019;33(6):1487-1500.
- Falconi G, Fabiani E, Fianchi L, et al. Impairment of PI3K/AKT and WNT/beta-catenin pathways in bone marrow mesenchymal stem cells isolated from patients with myelodysplastic syndromes. *Exp Hematol*. 2016;44(1):75-83.e1-4.
- Chen X, Li N, Weng J, et al., Senescent Mesenchymal Stem Cells in Myelodysplastic Syndrome: Functional Alterations, Molecular Mechanisms, and Therapeutic Strategies. *Front Cell Dev Biol*. 2021;8:617466.
- Blau O, Baldus CD, Hofmann WK, et al., Mesenchymal stromal cells of myelodysplastic syndrome and acute myeloid leukemia patients have distinct genetic abnormalities compared with leukemic blasts. *Blood*. 2011;118(20):5583-92.
- Wobus M, Mies A, Asokan N, et al. Luspatercept restores SDF-1-mediated hematopoietic support by MDS-derived mesenchymal stromal cells. *Leukemia*. 2021;35(10):2936-2947.
- Maurizi G, Mattiucci D, Mariani M, et al. DNA demethylating therapy reverts mesenchymal stromal cells derived from high risk myelodysplastic patients to a normal phenotype. *Br J Haematol*. 2017;177(5):818-822.
- Balderman SR, Li AJ, Hoffman CM, et al., Targeting of the bone marrow microenvironment improves outcome in a murine model of myelodysplastic syndrome. *Blood*. 2016;127(5):616-25.

## THE TUMOR MICROENVIRONMENT IN HODGKIN LYMPHOMA: CLINICAL IMPLICATIONS

S. Hohaus<sup>1,2</sup>

<sup>1</sup>Dipartimento di Diagnostica per Immagini, Radioterapia Oncologica ed Ematologia, Fondazione Policlinico Universitario A. Gemelli, IRCCS, Roma; <sup>2</sup>Dipartimento di Scienze radiologiche ed ematologiche, Università Cattolica del Sacro Cuore, Roma, Italy

A hallmark of Hodgkin lymphoma (HL) is the abundant inflammatory tumor microenvironment (TME) surrounding the neoplastic Hodgkin and Reed-Sternberg (HRS) cells. HRS cells shape the TME, and a complex crosstalk between immune and stromal cells in the TME guarantees immune escape, survival and proliferation of HRS cells. Direct cell-to-cell interactions, secretion of messenger proteins, exosomes, transfer of membrane proteins by trogocytosis and formation of extracellular traps are ways of communication in the TME. Studies using multigene signatures, mass cytometry, proteomic profiling and single cell RNA sequencing helped to elucidate the balance in number and functional state of the different cell populations characterizing the immunosuppressive TME and associations between TME characteristics and prognosis. T cells are the dominant cell population, and numerous

studies addressed the functional state of T cells in the microenvironment underlining a shift to a regulatory and T helper 2 functional state among the CD4+ cells and an inefficient cytotoxic T cell (CTL) response as typical for the TME in HL. Myeloid cells, including both tissue macrophages and granulocytes, appear to play a pivotal role in shifting T cell function. Tumor-associated macrophages (TAM) are often skewed to the alternatively activated M2 phenotype, that typical associates with negative immune regulation. TAM in HL overexpress the checkpoint PD-L1 and form biological niches together with PDL-1 expressing HRS cells. The PD-L1/PD-1 axis has become a therapeutic target of prime importance in HL, and other immune checkpoints as LAG-3 and TIGIT are currently explored.

Only recently we began to understand the mutational landscape of HL, and knowledge of the impact of genetic alterations on the TME is still limited. The frequent amplification of the genomic region encompassing the PDL-1 gene lead to PDL-1 overexpression in HRS cells and presumed suppression of T cell function, associated with a worse prognosis, but with better response to checkpoint inhibition. Mutations in beta2microglobulin gene are associated with a reduced MHC1 expression, probably rendering HRS cells less susceptible to control by CTL. The most frequent genetic alterations involve genes involved in cytokine signaling pointing to the pivotal role that cytokine networks play in HL.

Many attempts are directed to find peripheral blood (PB) markers that mirror the dysregulated immune functions in the TME. A high ratio between monocytes or neutrophils and lymphocytes (M/L and N/L ratio), and a higher number of myeloid cells with an immunosuppressive function the so-called myeloid-derived suppressor cells (MDSC) in PB have been associated with poor prognosis. Overexpression of PD-L1 on granulocytes in PB is also associated with worse outcome. A spillover of proteins from the TME into the circulation is the basis for the use of these soluble factors as circulating biomarkers in HL. Among these are the cytokines IL-6 and IL-10, the chemokine TARC, and soluble membrane proteins as sCD30 and more recently sPDL-1.

In conclusion, many biological characteristics of the TME have an impact on prediction of prognosis in HL. Disturbing the TME dynamics has already begun to become a strategy in novel treatment approaches in HL.

## EMN ITALY LECTURE: MICROENVIRONMENT AND MINIMAL RESIDUAL DISEASE IN MULTIPLE MYELOMA

M. D'Agostino

*SSD Clinical Trial in Oncoematologia e Mieloma Multiplo, Division of Hematology, University of Torino, Azienda Ospedaliero-Universitaria Città della Salute e della Scienza di Torino, Torino, Italy*

Multiple myeloma (MM) is a hematologic malignancy due to the clonal proliferation of malignant plasma cells in the bone marrow. MM is invariably preceded by asymptomatic stages of the disease called monoclonal gammopathy of undetermined significance (MGUS) and smoldering multiple myeloma (SMM) and the progression to a symptomatic disease is significantly affected not only by changes in the malignant plasma cell clone but also by changes in the tumor microenvironment. Indeed, malignant plasma cells in order to acquire a proliferation and survival advantage and to avoid immune surveillance exploit cell-cell interactions and soluble factors in the bone marrow niche interacting with multiple cell types (*e.g.* mesenchymal stromal cells, osteoclasts, osteoblasts, myeloid and lymphoid cells). MM patients' survival has been consistently prolonged thanks to the introduction of new therapeutic agents in the last 2 decades, however it is still considered an incurable disease. It is now possible to induce deep responses using combinations of the available drug classes and the eradication of minimal residual disease (MRD) measured by very sensitive methods is one of the most important factors predicting long-term survival. However, many patients still experience relapse and a failure to sustain MRD negativity over time could be observed. Tumor microenvironment is important in some of

the mechanisms of resistance to anti-MM therapy and there is initial evidence that normalizing tumor microenvironment even at MRD negative stages could be as important as eradicating the plasma cell clone in order to prevent relapse. In this presentation the available evidence on microenvironment roles in MM especially when MRD negativity is reached will be discussed.

## NOVEL TARGET ANTIGENS FOR CAR-T CELL THERAPY

V.M. Perriello, B. Falini

*Institute of Hematology, Department of Medicine, Center for Hemato-Oncological Research (CREO), University of Perugia, Perugia, Italy*

Chimeric antigen receptor T (CAR-T) cell therapy has provided a major breakthrough in the treatment of relapsed/refractory B-Acute Lymphoblastic Leukemia (B-ALL), B-Non Hodgkin Lymphomas (B-NHL) and Multiple Myeloma (MM), targeting CD19 and BCMA<sup>1</sup>. Those molecules have been chosen for their almost ideal cancer antigen characteristics, as expressed on tumor cell surface while absent in vital tissues. Despite such safety profile, long-term efficacy is still limited to 40-50% of Diffuse Large B-cell Lymphomas (DLBCL) and MM<sup>2</sup>. Target antigen loss or downregulation is probably the most common mechanism by which tumor cells may limit effectiveness of CAR T cell therapy<sup>3</sup>, leading to antigen negative relapse in 7-25% B-ALL, 30% DLBCL and 8-67% MM<sup>4</sup>. Therefore, to further improve CAR-T cells efficacy, alternative targets should be selected also upon their importance for malignant cells proliferation, beyond specificity. The less significant for tumor functions the target is, the easier is for cancer cells to hide it from CAR recognition. Among B-cell markers, CD79B could be considered an excellent target for CAR-T cell therapy for several reasons: i) highly expressed in most B-NHL regardless of stage, subtype, cytogenetic and molecular features<sup>5</sup>; ii) as part of B cell-antigen receptor (BCR) complex, is required for maintaining lymphoma cell growth, suggesting the importance of such antigen for cell survival and proliferation<sup>6</sup>; iii) still expressed at patient relapse after anti-CD19 and anti-CD22 CAR T-cell therapies due to CD19 or CD22 antigen escape<sup>7</sup>. Recently, our group generated a novel murine anti-human CD79B monoclonal antibody specifically targeting an extracellular CD79B epitope and identifying both CD79B isoforms to overcome possible tumor escape mechanism due to splice variants. Unique antibody single chain fragment variable (scFv) was exploited to design a novel anti-CD79b CAR, that shown preclinical efficacy against DLBCL and MM cell lines. An additional issue limiting the effectiveness of CAR-T cell therapy is antigen heterogeneity. A paradigmatic example is Acute Myeloid Leukemia (AML), where T-cell engineering approaches with CARs are limited by the paucity of truly tumor-specific target antigens<sup>8</sup>. In such context, choosing combinatorial targeting models may provide restrict selectivity of CAR-T cells joining potency with safety. We recently demonstrated the possibility to target specifically two well know AML antigens (CD123 and CD33)<sup>9</sup> in a non-canonical way, to minimize toxicity against healthy cells. In this dual target strategy, T cell activation occurred only after the simultaneous engagement of both receptors by CD123+/CD33+ leukemic cells, whilst enabling a weaker or null cell reactivity in response of CD123+ endothelium and CD33+ hematopoietic cells<sup>10</sup>.

In conclusion, target selection is probably the most important aspect when developing a novel CAR. Fundamental features to be considered are antigen specificity, integrity for tumor cell functions and persistence over time.

## References

- Gill, Saar, and Jennifer N Brudno. "CAR T-Cell Therapy in Hematologic Malignancies: Clinical Role, Toxicity, and Unanswered Questions." American Society of Clinical Oncology educational book. American Society of Clinical Oncology. Annual Meeting vol. 41 (2021): 1-20. doi:10.1200/EDBK\_320085.
- Sterner, R.C., Sterner, R.M. CAR-T cell therapy: current limitations and poten-

- tial strategies. *Blood Cancer J.* 11, 69 (2021). <https://doi.org/10.1038/s41408-021-00459-7>.
3. Orlando EJ, Han X, Tribouley C, Wood PA, Leary RJ, Riester M, et al. Genetic mechanisms of target antigen loss in CAR19 therapy of acute lymphoblastic leukemia. *Nat Med.* 2018;24(10):1504–6.
  4. Lemoine, J., Ruella, M. & Houot, R. Born to survive: how cancer cells resist CAR T cell therapy. *J Hematol Oncol* 14, 199 (2021). <https://doi.org/10.1186/s13045-021-01209-9>.
  5. Ding, Shengnan et al. “Targeting CD79b for Chimeric Antigen Receptor T-Cell Therapy of B-Cell Lymphomas.” *Targeted oncology* vol. 15,3 (2020): 365-375. doi:10.1007/s11523-020-00729-7.
  6. Havranek, Ondrej et al. “Tonic B-cell receptor signaling in diffuse large B-cell lymphoma.” *Blood* vol. 130,8 (2017): 995-1006. doi:10.1182/blood-2016-10-747303
  7. Ormhøj, Maria et al. “Chimeric Antigen Receptor T Cells Targeting CD79b Show Efficacy in Lymphoma with or without Cotargeting CD19.” *Clinical cancer research : an official journal of the American Association for Cancer Research* vol. 25,23 (2019): 7046-7057. doi:10.1158/1078-0432.CCR-19-1337.
  8. Marofi, F., Rahman, H.S., Al-Obaidi, Z.M.J. et al. Novel CAR T therapy is a ray of hope in the treatment of seriously ill AML patients. *Stem Cell Res Ther* 12, 465 (2021). <https://doi.org/10.1186/s13287-021-02420-8>
  9. Ehninger, A et al. “Distribution and levels of cell surface expression of CD33 and CD123 in acute myeloid leukemia.” *Blood cancer journal* vol. 4,6 e218. 13 Jun. 2014, doi:10.1038/bcj.2014.39
  10. Vincenzo Maria Perriello et al. “CD123 and CD33 Co-Targeting By Balanced Signaling on CAR-CIK Cells Reduces Potential Off-Target Toxicity While Preserving the Anti-Leukemic Activity of Acute Myeloid Leukemia”. *Blood* 2021; 138 (Supplement 1): 1699. doi: <https://doi.org/10.1182/blood-2021-150487>



## BEST ABSTRACTS

## B01

## CRISPR/CAS9-BASED GENOME EDITING TO MODEL THE ANTI-LEUKEMIA IMMUNE RESPONSE AND IDENTIFY ITS MOLECULAR PLAYERS

G. Ciliberto<sup>1,3</sup>, E. Draghi<sup>1,3</sup>, L. Zito<sup>1</sup>, A. Migliara<sup>2,3</sup>, A. Andrisani<sup>1</sup>, D. Cittaro<sup>5</sup>, M. Casucci<sup>6</sup>, C. Bonini<sup>3,4</sup>, F. Ciceri<sup>3,7</sup>, A. Lombardo<sup>2,3</sup>, L. Vago<sup>1,3,7</sup>

<sup>1</sup>Unit of Immunogenetics, Leukemia Genomic and Immunobiology; Division of Immunology, Transplantation and Infectious Disease; <sup>2</sup>San Raffaele Telethon Institute for Gene Therapy (SR-Tiget); <sup>3</sup>Vita-Salute San Raffaele University; <sup>4</sup>Experimental Hematology Unit; Division of Immunology, Transplantation and Infectious Disease; <sup>5</sup>Center for Translational Genomics and Bioinformatics; <sup>6</sup>Innovative immunotherapy Unit; Division of Immunology, Transplantation and Infectious Disease; <sup>7</sup>Hematology and Bone Marrow Transplantation Unit

**Introduction:** Over the last few decades, considerable progress has been achieved in elucidating the key aspects of the interplay between Acute Myeloid Leukemia (AML) and the immune system, but the fine molecular mechanisms of this interaction remain largely unknown. Here we fine-tuned and validated strategies to genetically modify AML blasts using the CRISPR/Cas9 targeted genome editing technology, and by this system probed the contribution of selected genes of interest to antileukemic immune responses both *in vitro* and *in vivo*.

**Methods:** To study the mechanisms of leukemia immune evasion, we knocked-out key immune genes in AML cell lines and in primary cells expanded in patient-derived xenografts (PDXs). To perform editing of the desired genes, we employed ribonucleoprotein electroporation, and in parallel optimized two-step transduction with separate lentiviruses to introduce, respectively, the Cas9 gene and the desired single guide RNA (sgRNA). Functional consequences of gene knock-out have been tested *in vitro*, using mixed lymphocyte cultures, and *in vivo*, exposing AML PDXs to human T cells.

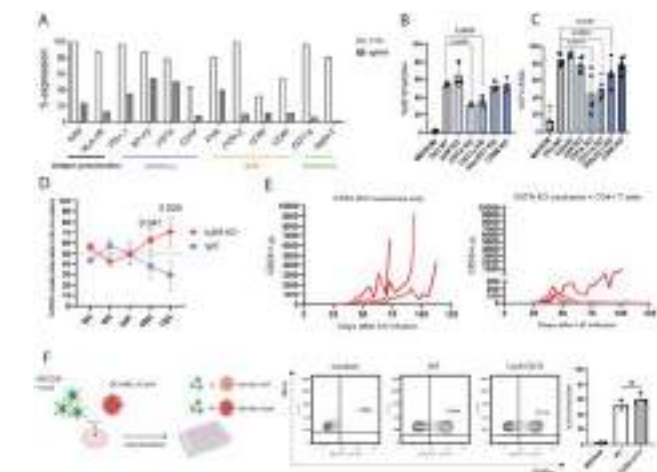

Figure 1.

**Results:** We were able to successfully knock-out a number of immune genes of interest in leukemic cells (Figure 1A). By *in vitro* experiments, we showed that CD11a ( $p=0.0003$ ) and Siglec-7 ( $p=0.019$ ) are key modulators of CD4+ T cell-mediated antileukemic responses (Figure 1B,C), and that blasts that are knocked-out for HLA class I molecules outgrow their wild-type counterpart when challenged with human T cells (Figure 1D). In the PDX model, we unexpectedly documented the ability of puri-

fied human CD4+ T cells to recognize and eliminate HLA class II-knock out leukemic cells (2/3 mice, Figure 1E), through a mechanism currently under investigation. We showed that the immunogenicity of the constitutively expressed Cas9 is detectable but outweighed by anti-HLA alloreactivity in our model (Figure 1F). We are currently testing *in vitro* and *in vivo* the contribution of a wide library of more than 600 immune genes to conventional HLA-restricted T cell-mediated recognition (using as effectors human alloreactive T cells) or to non-HLA-restricted killing (using CAR-T cells as effectors).

**Conclusions:** In conclusion, our innovative model provides the means to investigate in unprecedented detail the interactions between leukemia and the immune system, and potentially to identify new actionable targets for next-generation immunotherapies.

## B02

## ABSTRACT WITHDRAWN

## B03

## DEREGULATION OF THE TRANSFORMING GROWTH FACTOR-B PATHWAY IN LOW-RISK MDS PATIENTS SF3B1 MUTATED

A. Cristiano<sup>1</sup>, G. Silvestrini<sup>1</sup>, H. Hajrullaj<sup>1</sup>, E. Galossi<sup>1</sup>, G. Falconi<sup>1</sup>, R. Palmieri<sup>1</sup>, S. Hutter<sup>2</sup>, N. Nadarajah<sup>2</sup>, S. Gumenyuk<sup>3</sup>, F. Buccisano<sup>1</sup>, S. Fenu<sup>4</sup>, R. Latagliata<sup>5</sup>, T. Haferlach<sup>2</sup>, M.T. Voso<sup>1</sup>, E. Fabiani<sup>1,6</sup>

<sup>1</sup>Department of Biomedicine and Prevention, University of Tor Vergata, Rome, Italy; <sup>2</sup>MLL Munich Leukemia Laboratory, Munich, German; <sup>3</sup>IFO - Istituto Nazionale Tumori Regina Elena, Rome, Italy; <sup>4</sup>Azienda Ospedaliera San Giovanni Addolorata, Rome, Italy; <sup>5</sup>Unità Operativa Complessa (UOC) Ematologia, Ospedale Belcolle, Viterbo and Division of Cellular Biotechnology and Hematology, Sapienza University, Rome, Italy; <sup>6</sup>UniCamillus-Saint Camillus International University of Health Sciences, Rome, Italy

**Introduction:** Myelodysplastic syndromes (MDS) represent a heterogeneous group of hematologic malignancies affecting the hematopoietic stem cell that are mainly sub-grouped according to the number of dysplastic lineages, presence or absence of ring sideroblasts, percentage of bone marrow and peripheral blood blasts and type of cytogenetic alterations. Splicing factors (SF) genes (SF3B1, SRSF2 and U2AF1), have been reported as frequently mutated in MDS, leading to defects in RNA maturation and production of variants with a different or impaired biological activity, resulting in an altered gene expression profile. Mutations in SF3B1 have been also tightly associated to the particular phenotype with ring sideroblasts.

**Methods:** From an initial cohort of 300 MDS, of which we had paired DNA and RNA BM-MNCs collected at the time of diagnosis and classified according to their mutational profile performed by t-NGS, we selected a study cohort of 50 LR-MDS (30 male and 20 female, median age 75 years, range 40-91) enriched for mutations in SF genes. This cohort was analyzed by Whole Genome sequencing (WGS) to identify additional mutated genes, not previously analyzed by t-NGS, and by RNA-seq to assess the expression profile. The enrichment pathways analysis of RNA data was performed by DAVID bioinformatics tool and selected genes were validated by Q-RT-PCR. Bone marrow samples from 64 non-hematological patients were used as a control group.

**Results:** WGS showed that ACLY gene was mutated at high frequency in SF3B1mut (90%) and SRSF2mut (50%) patients, but not in U2AF1mut (0%). Data obtained from whole transcriptome analysis showed an altered expression profile in LR-MDS patients ( $n=46$ ) vs controls ( $n=64$ ). In particular, 300 genes were up-regulated, while 3921 were down-regulated. The stratification of the analysis, according to the presence of mutations in SF3B1, SRSF2 and U2AF1, led to the identification of differentially expressed genes (DEGs) in each patients' subgroup (622 in SF3B1mut, 13 in SRSF2mut and only 4 in U2AF1mut patients). The "pathways enrichment analysis" ( $\text{padj} < 0.05$  and  $\log_2 \text{FC} \geq 2$  and  $\leq -2$ ) identified 37 deregulated pathways in LR-MDS harboring SF3B1 mutations. Six DEGs belonging to the TGF- $\beta$  pathway (CHRD, DCN, SMAD9, FST, ID4, PITX2) and 10 in modulator of TGF- $\beta$  activity

(BDNF, BMPER, COL1A1, COL1A2, FN1, GLI2, IGF1, MMP2, NFIB and PLAU) were identified and all tested genes (n=7) were validated by Q-RT-PCR (DEGs in SF3B1mut vs SFwt: DCN, p=0,0043; FN1, p=0,0043; MMP2, 0,0043; FST, p=0,0173; IGF1, p=0,0030; SAMD9, 0,030 and PLAU, p=0,0087).

**Conclusions:** Our study showed that LR-MDS display an altered and extremely heterogeneous gene expression profile according to the presence of specific mutations in SF genes. In particular, SF3B1mut patients showed a deregulation of genes belonging to TGF- $\beta$  pathway, suggesting their possible role as molecular targets in the context of new therapies.

## B04

### LIQUID BIOPSY PROVIDES COMPLEMENTARY INFORMATION TO TISSUE BIOPSIES FOR THE MOLECULAR CLASSIFICATION OF DLBCL PATIENTS

R. Moia<sup>1</sup>, C. Favini<sup>1</sup>, D. Talotta<sup>1</sup>, S. Sagiraju<sup>1</sup>, R. Bruna<sup>1</sup>, I. Della Starza<sup>2</sup>, R. Scoscia<sup>2</sup>, V. Ferri<sup>1</sup>, A. Andorno<sup>3</sup>, F. Mercalli<sup>3</sup>, C. Deambrogi<sup>1</sup>, S. Rasi<sup>1</sup>, L. Petrucci<sup>2</sup>, T. Bellissimo<sup>2</sup>, R.L. Boldorini<sup>3</sup>, A. Di Rocco<sup>2</sup>, I. Del Giudice<sup>2</sup>, M. Martelli<sup>2</sup>, R. Foà<sup>2</sup>, G. Gaidano<sup>1</sup>

<sup>1</sup>Division of Hematology, Department of Translational Medicine, Università del Piemonte Orientale, Novara; <sup>2</sup>Division of Hematology, Department of Translational and Precision Medicine, 'Sapienza' University, Rome; <sup>3</sup>Division of Pathology, Department of Health Sciences, Università del Piemonte Orientale, Novara, Italy

**Introduction:** Diffuse large B-cell lymphoma (DLBCL) displays a high degree of molecular heterogeneity and may be classified into molecular clusters harboring specific lesions and therapeutic vulnerabilities. To date, DLBCL molecular clusters are identified on the tissue biopsy and do not consider mutations deriving from different anatomical compartments. The aim of this study is to evaluate the potential contribution of liquid biopsy to the identification of DLBCL molecular clusters.

**Methods:** A multicenter cohort of newly diagnosed DLBCL provided with circulating tumor DNA (ctDNA) from the plasma and with genomic DNA (gDNA) from the lymph node (LN) biopsy represented the basis of this study. The LyV4.0 CAPP-Seq assay that comprised a panel of 59 genes relevant to B-cell malignancies was used. The LymphGen tool v1.0 was utilized for cluster analysis.

**Results:** The cohort included 77 newly diagnosed DLBCL patients treated with R-CHOP. After a median follow up of 27.1 months, the 36-month PFS and OS were 62.0% and 79.5%. Mutation analysis identified at least one somatic non-synonymous mutation in 92.2% (71/77) of patients in the LN biopsy and in 87.0% (67/77) in the ctDNA. Higher levels of ctDNA ( $\geq 2.5$  log hGE/mL) were associated with a significantly worse PFS (p=0.025) and OS (p=0.004). Mutation analysis of different compartments, *i.e.* lymph node and plasma, allowed to identify mutations with potential clinical impact, that otherwise would have been missed by analyzing only one compartment. In particular, *GRHRP* (p=0.035) and *SGK1* (p=0.039) mutations identified only on the liquid biopsy, and *MYC* mutations identified only on the LN biopsy (p=0.021) were associated with a shorter PFS. Based on the mutational landscape identified in each compartment, DLBCL were analyzed with the LymphGen tool, that allows the cluster assignment in approximately 40-50% of DLBCL. In our cohort, 46.5% (33/71) of cases were assigned to a specific molecular cluster on the LN biopsy and 40.3% (27/67) on the liquid biopsy. Interestingly, one case was classified as EZB on the LN biopsy and as MCD on the ctDNA (Figure 1A). In all other cases, if not unclassified, the cluster identified on the ctDNA reflected the cluster identified on the LN biopsy. The combination of mutational data from LN and ctDNA improved DLBCL assignment to a specific cluster, thus classifying 51.4% (34/74) of cases. Two patients were assigned to two different clusters and defined as genetically composite. From a clinical perspective, by combining mutational data from the LN and from ctDNA, patients belonging to the BN2 and ST2 clusters showed a favorable outcome with a 36-month PFS of 100% compared to 62.3% for patients belonging to the MCD or EZB clusters (p=0.040) (Figure 1B-C).

**Conclusions:** The combination of mutational data from the LN biopsy and from the liquid biopsy provides complementary information for

the molecular classification and prognostic stratification of newly diagnosed DLBCL patients.

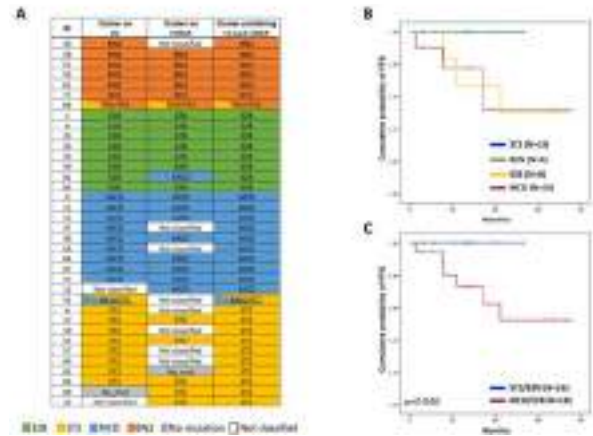

Figure 1.

## B05

### PROGNOSTIC VALUE OF IMMUNE CELLS IN THE MULTIPLE MYELOMA BONE MARROW MICROENVIRONMENT: A META-ANALYSIS WITH IN SILICO AND IN VITRO VALIDATION

A.G. Solimando<sup>1,2</sup>, N. Susca<sup>1</sup>, P. Borrelli<sup>3</sup>, M.C. Da Vià<sup>4,5</sup>, M.A. Frassanito<sup>1</sup>, V. Desantis<sup>1</sup>, M. Montagnani<sup>6</sup>, I. Saltarella<sup>1</sup>, A. Melaccio<sup>1</sup>, R. Ria<sup>1</sup>, C. Terragna<sup>7</sup>, H. Einsele<sup>8</sup>, A. Vacca<sup>1</sup>

<sup>1</sup> Guido Baccelli Unit of Internal Medicine, Department of Biomedical Sciences and Human Oncology, School of Medicine, Aldo Moro University of Bari; <sup>2</sup> Medical Oncology Unit, IRCCS Istituto Tumori "Giovanni Paolo II" of Bari; <sup>3</sup> Laboratory of Biostatistics, Department of Medical, Oral and Biotechnological Sciences, G. d'Annunzio University of Chieti-Pescara; <sup>4</sup> Hematology Unit, Fondazione IRCCS Ca' Granda Ospedale Maggiore Policlinico, Milan, Italy; <sup>5</sup> Department of Oncology and Hemato-Oncology, University of Milan, Milan, Italy; <sup>6</sup> Department of Biomedical Sciences and Human Oncology - Section of Pharmacology, Medical School, University of Bari "Aldo Moro"; <sup>7</sup> IRCCS Azienda Ospedaliero-Universitaria di Bologna, Istituto di Ematologia "Seràgnoli"; <sup>8</sup> University Hospital Würzburg

During multiple myeloma (MM) immunoeediting, the immune cells can be effective in eliminating the initiating tumor MM cells (MMPCs) in the elimination phase or at least, in the equilibrium phase, which can prompt functional dormancy at early stages. However, malignant MMPCs can take advantage of immune dysfunction and permissive immune microenvironment to escape immune elimination, proliferate and generate active MM. We performed a systematic literature research, as follows: (multiple myeloma) AND (mast cell\* OR macrophage\* OR dendritic cell\* OR NK cell\* OR regulatory T cell\* OR CD3 T-lymphocyte\* OR CD4 T-lymphocyte\* OR CD8 T-lymphocyte\* OR B cell\* OR CTLA-4 antigen\* OR Antigen\* CD274 OR PD-L1 OR PD1 OR BCMA OR SLAMF7) AND (observational OR case-control OR cohort OR overall-survival OR OS). This systematic review and meta-analysis follow the PRISMA consensus standards. The hazard ratio (HR) for overall survival (OS) was chosen as the main outcome. We performed a fixed effect or random effects meta-analysis, as appropriate, using the inverse variance method. P-values < .05 were considered statistically significant. We employed Rstudio version 1.2.5033. Next, we evaluated the local immune cell anti-MM immunity using a supervised transcriptomic approach. We generated a discovery dataset, from 6 sources and interrogated 7 validation datasets. As target genes we used a supervised approach with selected genes known to be representative of key immune mechanisms and cancer microenvironment. To determine whether there was at least one gene in a gene-set with an association with OS we did a ridge regression analysis. If these groups had at least one gene that was associated with OS, they were also interrogated in the validation

dataset. By applying a Cox regression for each individual gene for each individual dataset, and a meta-analysis performed. The genes that kept the statistical significance after multiple testing in the discovery data were applied to the validation data, in which the same analysis was performed and the selected genes significant after multiple testing were included into a multivariable model corrected for ISS. 5021 articles were found with the literature research, which became 3713 after duplicates removal. After title and abstract screening, 178 articles underwent full-text examination. Of these, 10 were included in the meta-analysis. While investigating candidate gene expression within the validation dataset, only VISTA, FABP5 and ITGB1 remained significant with HR 0.75 ( $P < .005$ ), 14.42 ( $P < .001$ ), 4.71 ( $P < .05$ ), respectively. Subsequently, we functionally validated the downstream pathways related to cytoskeleton rearrangement, proliferation, epithelial-mesenchymal transition, and dissemination (Figure 1). Collectively, it is tempting to envision a pivotal role played by the M2 macrophages in MM progression, orchestrating an increased expression of immune checkpoints with a significant impact on MM OS.

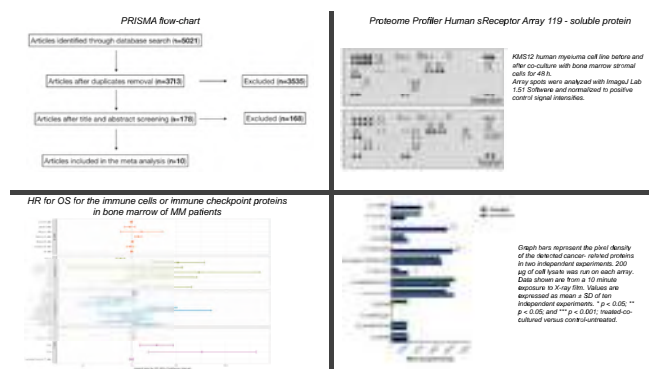

Figure 1.

## B06

### ANALYSIS OF EVOLUTION PATTERN OF CLONAL HEMATOPOIESIS OF INDETERMINATE POTENTIAL (CHIP)'S SOMATIC MUTATIONS PROFILE IN TRANSPLANT ELIGIBLE MULTIPLE MYELOMA PATIENTS USING A SINGLE CELL APPROACH

E. Borsi<sup>1</sup>, I. Vigliotta<sup>1</sup>, A. Poletti<sup>1,2</sup>, V. Solli<sup>1,2</sup>, M. Martello<sup>1</sup>, L. Zazzeroni<sup>1</sup>, S. Armuzzi<sup>1,2</sup>, E. Zamagni<sup>1,2</sup>, L. Pantani<sup>1,2</sup>, S. Rocchi<sup>1,2</sup>, K. Mancuso<sup>1,2</sup>, P. Tacchetti<sup>1,2</sup>, I. Rizzello<sup>1,2</sup>, S. Rizzi<sup>1</sup>, E. Dan<sup>1,2</sup>, B. Sinigaglia<sup>1,2</sup>, M. Cavo<sup>1,2</sup>, C. Terragna<sup>1</sup>

<sup>1</sup>IRCCS Azienda Ospedaliero-Universitaria di Bologna; <sup>2</sup>DIMES – Department of Experimental, Diagnostic and Specialty Medicine, University of Bologna, Seragnoli Institute of Hematology, Italy

**Introduction:** Clonal hematopoiesis of indeterminate potential (CHIP) may occur when a hematopoietic stem cell acquires a fitness-increasing mutation, resulting in its clonal expansion. The progression mechanism of CHIP to hematological malignancies is not fully understood. CHIP is a common entity among Multiple Myeloma (MM) patients (pts), associated with a worse progression free survival in pts without an Immunomodulatory (IMiD) regimen after autologous stem cell transplantation (ASCT), due to a MM progression.

**Aim:** To identify CHIP-somatic mutations (CHIPsm), which can create the molecular background of a neoplastic process and define if the presence of CHIP at the time of ASCT affects clinical outcomes. We have also analyzed paired samples in order to ascertain the existence of clonal evolution patterns related to CHIP.

**Patients and Methods:** High throughput amplicon-based single-cell DNA sequencing was performed on apheresis-derived CD34+ cells from 11 MM pts who underwent ASCT. Moreover, for 4 MM pts longitudinal samples (*i.e.* baseline bone marrow CD34+) were collected. Single-cell sequencing and data analysis were assessed using the MissionBio

Tapestri® platform, with a targeted panel of 20 leukemia-associated genes.

**Results:** An average of 7937 cells were genotyped (range 904-18571) with a median number of 31 (range 19-46) variants per pt, in both coding and intronic regions. Coding non-synonymous variants were detected in 15 out of 20 genes. Putative deleterious coding variants were observed in 11 genes. The most common non-synonymous CHIPsm were found in TET2 (47%), KIT (20%), and DNMT3A (15%). We identified 5 (45%) pts harbouring pathogenic CHIPsm. A single CHIPsm was detected in 3/5 pts (60%), while 2 pts (40%) had 2 or more mutations in different genes. Notably, we identified co-localized mutations in 1 pt in the same sub-clone (SC). Consistent with prior studies, 66% of DNMT3A mutations were truncating and 34% were missense. The TET2, KIT and NRAS mutations were all missense. For 4 pts, we also analysed longitudinal samples: we did not observe changes in the apheresis with respect to diagnosis in 3 pts, suggesting the existence of a linear evolution of SCs. Notably, we detected an increase of the percentage of SCs with a specific high-fitness variant in the apheresis, possibly driven by treatment and/or mobilization regimen selective pressure. In 1 pt, we found a passenger mutation in NRAS at the diagnosis but not in the apheresis. The median age at the time of ASCT in pts with CHIP was 58 (46-69) years, while 64 (60-67) in pts without CHIP.

**Conclusion:** By employing a single-cell technology, we were able to identify rare pathological variants in the compartment of CD34+ cells collected and subsequently re-infused in MM pts. A sub-clone dynamic of high-fitness mutations over time was confirmed. These findings suggest that monitoring the dynamics of CHIPsm prospectively will benefit pts' clinical management.

**Acknowledgements:** BolognaAILONLUS, AIRCIG2019

## B07

### APPLICATION OF AI-BASED ANALYTICAL APPROACHES FOR MULTIPLEX IMMUNOPHENOTYPING OF SF3B1-MUTANT MYELODYSPLASTIC SYNDROME SUBTYPE

S. Winter<sup>1</sup>, J. Timms<sup>2</sup>, U. Oelschlaegel<sup>1</sup>, A. Tunger<sup>3</sup>, P. Parker<sup>2</sup>, C. Harrison<sup>4</sup>, D. Choy<sup>2</sup>, M. Schmitz<sup>3</sup>, U. Platzbecker<sup>5</sup>, S. Kordasti<sup>2,4</sup>

<sup>1</sup>Department of Internal Medicine I, University Hospital Carl Gustav Carus, TU Dresden; <sup>2</sup>Comprehensive Cancer Centre, School of Cancer and Pharmaceutical Sciences, King's College London; <sup>3</sup>Institute of Immunology, Faculty of Medicine, TU Dresden; <sup>4</sup>Haematology Department, Guy's and St Thomas' NHS Foundation Trust, London, United Kingdom; <sup>5</sup>Medical Clinic and Policlinic 1, Hematology and Cellular Therapy, University of Leipzig Medical Center

**Background:** Somatic mutations in splicing factor 3B subunit 1 (SF3B1) occur in 25% of all myelodysplastic syndromes (MDS) cases and identify a condition characterized by ring sideroblasts, ineffective erythropoiesis, and indolent disease course in lower-risk (LR) MDS. The impact of SF3B1 mutations on erythroid dysregulation has become apparent but little is known about cellular immune phenotypes. Identification of patient characteristics downstream of the pathogenic mutations in SF3B1 may reveal immunological determinants of disease phenotype and response to therapeutic interventions (*e.g.* luspatercept). In the present study, we applied multiplex immunophenotyping technologies in combination with artificial intelligence (AI)-based analytical approaches to identify genotype- immunophenotype correlations that may affect disease course and clinical outcomes in the SF3B1-MDS subtype.

**Methods:** We performed transcriptomic immune profiling on bone marrow (BM) mononuclear cells (MNCs) from 12 SF3B1-MUT and 10 SF3B1-WT LR-MDS patients using the NanoString nCounter PanCancer Immune Profiling Panel. Viable frozen PBMC samples (8 SF3B1-MUT; 4 SF3B1-WT) were thawed and stained for CyTOF with a 35-marker MaxPar Immune Profiling Panel (Fluidigm) for deep immune profiling. CyTOF data were analyzed with an in-house developed pipeline (ImmunoCluster, Opzomer *et al.* 2021) incorporating the FlowSOM algorithm for unsupervised clustering (K=70). We also retrieved flow cytometric data on fresh BM and peripheral blood (PB) samples acquired independently as part of the diagnostic work-up and re-analyzed them using the T-REX pipeline (Barone and Paul *et al.* 2020).

**Results:** On the transcriptomic level, the SF3B1-MUT subtype showed a distinct inflammatory signature compared to SF3B1-WT (59 DE genes at FDR < 0.05, Figure 1A and B). GO/KEGG pathway analysis indicated that downregulated genes in SF3B1-MUT patients are involved in antigen processing/presentation (HLA class II transcripts, CD8a), regulation of proinflammatory interleukin-1 beta secretion (IL1B, NLRP3), and cellular response to interferon-gamma (HLA class II transcripts, IRF4/8, CCL5, CCL20). Genes that were upregulated in SF3B1-MUT BM MNCs are involved in cell cycle (CDK1, CCND3), proliferation/survival (AXL), iron homeostasis (TFRC), and erythroid differentiation (TAL1). Unbiased interrogation of cellular phenotypes in PB through FlowSOM analysis of CyTOF data revealed an increased abundance of a CD4+ T cell metacluster resembling a central memory. (CM) phenotype in SF3B1-MUT compared to SF3B1-WT PBMCs (7.9 vs 4.5% of CD45+). Independent automated T-REX-based analysis of clinical flow data supported this finding and further indicated expansion of a cluster resembling CM CD8+ T cells in SF3B1-MUT PB. Lower IL1B expression in SF3B1-MUT and the implication of the IL-1/IL-1RAP axis in the inflammatory leukemic niche (De Boer et al. 2020) prompted us to re-analyze clinical flow cytometric data on IL-1RAP expression using the T-REX pipeline. T-REX revealed differences in IL-1RAP-expressing clusters between SF3B1-MUT and SF3B1-WT BM samples (9 SF3B1-MUT; 9 SF3B1-WT). Specifically, we noticed a cluster of IL-1RAP+ CD34- cells (HLA-DR+ CD123+) present in SF3B1-WT but greatly contracted in SF3B1-MUT MDS (Figure 1C and D). Our data suggest that proinflammatory signaling via the IL-1/IL-1RAP axis is reduced in SF3B1-MUT BM. Aberrant marker expression on SF3B1-MUT monocytes has been reported (Duetz et al. 2020). T-REX analysis of BM CD14+ cells revealed distinct monocyte clusters with differential expression of CD123, CD11b, and HLA-DR. Our initial analysis showed that SF3B1-MUT-specific clusters displayed lower expression of CD123 and CD11b, suggesting that mutations in SF3B1 directly or indirectly affect monocyte phenotypes and most likely function.

**Conclusions:** We provide evidence that the SF3B1-MDS subtype is associated with a distinct inflammatory signature characterized by lower IL1B expression, changed IL-1RAP+ clusters, distinct monocyte phenotypes, and preservation of T cell homeostasis. Further investigation of the immune signature in SF3B1-mutated MDS subtype may lead to using personalized immunotherapy strategies in the future. This work also exemplifies the potential of unsupervised strategies for interrogating cellular immune phenotypes in MDS subtypes within clinical flow cytometry datasets.

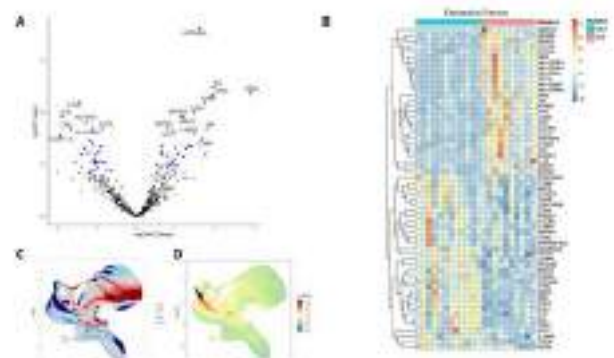

**Figure 1:** Differentially expressed genes (DEGs) in SF3B1-WT vs. SF3B1-MUT BM MNCs and T-REX analysis. (A) Volcano plot with DEGs (FDR < 0.05) highlighted in blue. (B) Heatmap depicting expression Z score of DEGs in individual patients. (C) T-REX analysis showing SF3B1-WT specific (blue) and SF3B1-MUT specific (red) cell clusters within CD34-negative BM cells and (D) IL-1RAP expression projected onto uniform manifold approximation and projection (UMAP) plot. A color indicates IL-1RAP positive cell cluster specific to SF3B1-WT samples.

**Figure 1.**

## B08

### BONE MARROW CD34+ PRECURSOR CELLS FROM JUVENILE MYELOMONOCYTIC LEUKEMIA SHOW A UNIQUE IMMUNOPHENOTYPIC PROFILE WITH IMPACT ON LABORATORY DIAGNOSIS

C. Bugarin<sup>1</sup>, L. Antolini<sup>2</sup>, C. Buracchi<sup>1</sup>, T. Coliva<sup>3</sup>, V.H. van der Velden<sup>4</sup>, T. Szczepanski<sup>5</sup>, A. van der Sluijs<sup>6</sup>, E. Sobral da Costa<sup>7</sup>, E. Mejstrikova<sup>8</sup>, C. Aanei<sup>9</sup>, van J.M. Dongen<sup>10</sup>, M.G. Valsecchi<sup>2</sup>, A. Orfao<sup>11</sup>, F. Locatelli<sup>12</sup>, A. Biondi<sup>1,2</sup>, G. Gaipa<sup>1</sup> on behalf of the EuroFlow Consortium

<sup>1</sup>Centro Ricerca Tettamanti, Clinica Pediatrica Università di Milano Bicocca; <sup>2</sup>Center of Biostatistics for Clinical Epidemiology, School of Medicine and Surgery, University of Milano-Bicocca; <sup>3</sup>Department of Pediatrics University of Milano-Bicocca, Fondazione MBBM/Ospedale San Gerardo; <sup>4</sup>Department of Immunology, Erasmus MC, University Medical Center Rotterdam; <sup>5</sup>Department of Pediatric Hematology and Oncology, Medical University of Silesia (SUM); <sup>6</sup>Dutch Childhood Oncology Group; <sup>7</sup>Department of Pediatrics, Federal University of Rio de Janeiro; <sup>8</sup>Department of Pediatric Hematology and Oncology, 2nd Faculty of Medicine, Charles University (DPH/O); <sup>9</sup>Hematology Laboratory CHU de Saint-Etienne; <sup>10</sup>Department of Immunohematology and Blood Transfusion (IHB) Leiden University Medical Center (LUMC); <sup>11</sup>Department of Medicine and Cytometry Service, University of Salamanca (USAL) and Institute of Biomedical Research of Salamanca (IBSAL); <sup>12</sup>Department of Pediatric Hematology and Oncology IRCCS Ospedale Pediatrico Bambino Gesù, Sapienza University of Rome

**Introduction:** Juvenile myelomonocytic leukemia (JMML) is a lethal myeloproliferative disease of young childhood characterized by an overproduction of myelomonocytic cells and an increased in vitro sensitivity of hematopoietic progenitors to granulocyte-macrophage colony-stimulating factor (GM-CSF). Diagnostic criteria for JMML are currently well established, however, in some patients diagnosis of JMML still remains a challenge, immunophenotyping being not part of the diagnostic work-up for this disease.

**Methods:** We studied 31 JMML patients at diagnosis (age range: 0-3 years, mean 1 years), 29 control subjects (age range: 0-12 years, mean 4 years) and 9 children with suspected diagnosis of JMML (median age 0.5 year; range 0-2 years) that was not subsequently confirmed. Cells were processed according to the Euroflow standard operating protocols. We focused on the CD34+ bone marrow (BM) cell compartment. CD34+ phenotypic parameters were measured by percentages and described by median (range) in JMML cases and control subjects. Comparison between cases and controls was performed by the non-parametric Wilcoxon rank sum test. The separation of the distribution of each component between cases and controls was investigated by the ROC curve. The cross validated area under the curves was used to rank the discriminatory potential of the components.

**Results:** We observed a strong reduction of B-cell and erythroid precursors in JMML as compared to controls, whereas monocytic and CD7+ lymphoid precursors resulted significantly enhanced. Aberrant precursors (i.e. CD7+/MPO+ or CD79a+/CD7+) were consistently present in JMML and virtually absent in controls. The greatest potential in discriminating JMMLs vs normal subjects (p<0.0001) was obtained with the CD34+/CD7+ lymphoid precursors in combination with the CD34+ aberrant precursors or in combination with the erythroid precursors (Area under the ROC curve were 0.973 and 0.983 respectively). These dual-combinations maintained their high efficiency even when used to discriminate between JMML and suspected non-confirmed JMML cases. When we analyzed the distribution of each single CD34+ phenotypic parameter among the JMML-associated genetic subtypes we found that the most significant markers tested in our score system retained their significance, although showing the following trend, in descendent order, proportional to associated clinical aggressiveness: NF1>PTPN11>RAS>CBL.

**Conclusions:** In the present report we show for the first time that CD34+ precursor cells from JMML patients display a unique immunophenotypic signature detectable with high feasibility and reproducibility in both BM and PB specimens by applying a standardized

flow cytometric Euroflow-validated protocol. The introduction of our approach in routine diagnostics can contribute to a faster and more precise diagnosis of JMML even in the presence of patients with confounding clinical signs.

**B09**

**THIRD GENERATION SEQUENCING OF NORMAL KARYOTYPE ACUTE MYELOID LEUKEMIA: IDENTIFICATION OF A DISEASE SUBSET WITH UNFAVORABLE PROGNOSIS. A MYNERVA-GIMEMA COLLABORATIVE STUDY**

F. Mannelli<sup>1</sup>, N. Bartalucci<sup>1</sup>, S. Romagnoli<sup>1</sup>, G. Gianfaldoni<sup>1</sup>, M. Piccini<sup>1</sup>, B. Scappini<sup>1</sup>, E. Pelo<sup>2</sup>, F. Pancani<sup>1</sup>, F. Vanderwert<sup>1</sup>, C. Maccari<sup>1</sup>, L. Signori<sup>1</sup>, A. Piciocchi<sup>3</sup>, E. Crea<sup>3</sup>, M.P. Fazi<sup>3</sup>, M. Vignetti<sup>3</sup>, A. Venditti<sup>4</sup>, F. Buccisano<sup>4</sup>, M.T. Voso<sup>4</sup>, S. Amadori<sup>3</sup>, P. Guglielmelli<sup>1</sup>, A.M. Vannucchi<sup>1</sup>

<sup>1</sup>SOD Ematologia, Centro Ricerca e Innovazione Malattie Mieloproliferative (CRIMM), AOU Careggi, Università di Firenze; <sup>2</sup>SOD Genetica Medica, AOU Careggi; <sup>3</sup>Fondazione GIMEMA; <sup>4</sup>Ematologia, Dipartimento di Biomedicina e Prevenzione, Università di Tor Vergata, Italy

**Introduction:** Acute myeloid leukemia (AML) is a heterogeneous disease with large differences in outcome. Among prognostic factors, karyotype and molecular genetics are the framework of European Leukemia Network (ELN) system. However, standard karyotyping reveals no abnormalities (abn) in about 50% of cases, merging different subsets within the normal karyotype (NK) group. This definition is based on a limited number of metaphases and may fail to capture chromosomal abn due to inherent technical issues. Despite the availability of recurrent gene mutations (NPM1, FLT3 and CEBPA), the prognostic assessment in NK-AML remains unsatisfactory. Third generation sequencing was developed to yield long-read genome sequencing and thus to reveal genomic structural variations (SV) that might escape conventional assessment. In our study, we aimed to characterize a large dataset of NK-AML pts using nanopore technology.

**Methods:** Patients: We enrolled pts diagnosed with intensively treated, NK-AML, based on conventional criteria from our institutional database and the prospective clinical trial GIMEMA AML1310. Pts were studied by conventional karyotype and molecular genetics and stratified according to 2010 ELN model. Long-read genome sequencing was performed by Oxford Nanopore technology (ONT). ONT sequencing data were analyzed by the CuteSV and Sniffles packages.

tivariate model and 8 NanoV kept an unfavorable prognostic value (Figure 1A). Patients harboring at least one of them (n=26, 17.1%) were classified as NanoV+. As compared to NanoV- group, NanoV+ pts were older (55 vs 49, P=0.046) and hadn't different patterns for NPM1 and FLT3-ITD mutations, whereas CEBPA mutants were mutually exclusive with NanoV presence. As displayed in Figure 1B-C, NanoV+ pts had significantly worse outcome, as demonstrated by lower CR rate (46.2% vs 80.9%, P<.0001), shorter DFS (6.5 months vs not reached, P<.0001) and OS (8.3 vs 62.3, P<.0001). Of note, nearly 90% of NanoV+ cases would have been classified as intermediate (n=13) and low-risk (n=10) according to standard ELN model.

**Conclusions:** In our cohort, Nanopore sequencing was able to reveal otherwise silent genetic abn and identified a group of pts with adverse outcome. Its incorporation into standard models could improve prognostic stratification and clinical management of pts with NK-AML. Supported by AIRC, GIMEMA and Legato Zottola.

**B10**

**CORRECTION OF THE DNMT3A MUTATION IN OCI-AML3 HARBOURING DNMT3AR882C MUTATION AND NPM1 MUTATION A DOES NOT AFFECT LEUKEMIA SURVIVAL AND GROWTH IN VITRO AND IN VIVO**

F. Milano<sup>1</sup>, C. Quadalti<sup>2</sup>, L. Albicocco Giovinati<sup>1</sup>, S. Pierangeli<sup>1</sup>, M. Sabino<sup>1</sup>, R. Ranieri<sup>1</sup>, S. Donnini<sup>1</sup>, I. Gionfriddo<sup>1</sup>, S. Silvestri<sup>1</sup>, F. Mezzasoma<sup>1</sup>, V. Ciauro<sup>1</sup>, V. Tini<sup>1</sup>, G. Spinozzi<sup>1</sup>, B. Falini<sup>1</sup>, M.P. Martelli<sup>1</sup>

<sup>1</sup>Centro Ricerche Emato-Oncologiche (CREO), Dipartimento di Medicina e Chirurgia, Università degli Studi di Perugia; <sup>2</sup>IRCCS Istituto delle Scienze Neurologiche di Bologna, Italy

**Introduction:** DNMT3A mutations are one of the most frequent genetic alterations in epigenetic modifiers in AML patients. DNMT3A mutations are found in age-related clonal hematopoiesis, are pre-leukemic mutations and often persist in AML patients at complete remission after therapy. Loss of DNMT3A in hematopoietic stem cells (HSCs) confers an *in vivo* immortality, with a self-renewal potential far exceeding that of normal HSCs, and a gradual and focal losses of DNA methylation in regions associated with self-renewal genes. Despite the current knowledge on the functions of DNMT3A and the established role of its mutations in driving leukemia, the role of DNMT3A mutations in leukemia maintenance, and thus as therapeutic target, remains to be established. Here, our aim was to investigate the essentiality of DNMT3A mutations for the maintenance of the AML once the disease is already established.

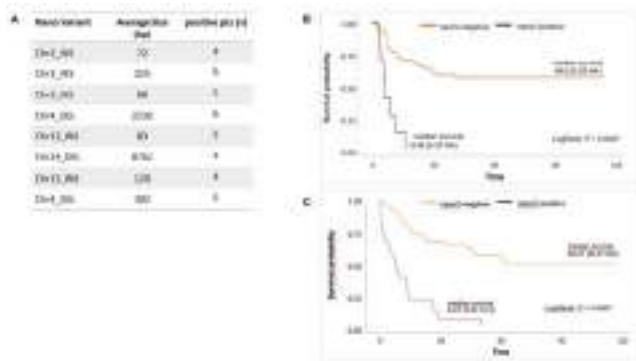

Figure 1.

**Results:** From 2010 to 2018, 152 pts were enrolled (median age 51). NPM1, FLT3-ITD and bi-allelic CEBPA mutations were found in 83 (54.6%), 36 (23.7%) and 12 (7.9%) cases, respectively. Overall, 114 pts (75%) entered CR and median OS was 45 months. Median number of SV was 95 (range 1-2226), most of which consisted of loss or insertion of genomic material in 49.9% and 49.0% of cases, respectively. The detected SV involved all 23 chromosomes. Median SV length was 2653 nucleotides; as expected, there were no large alterations (>50% of one chromosome arm). Observed NanoVariants (NanoV) were run in a mul-

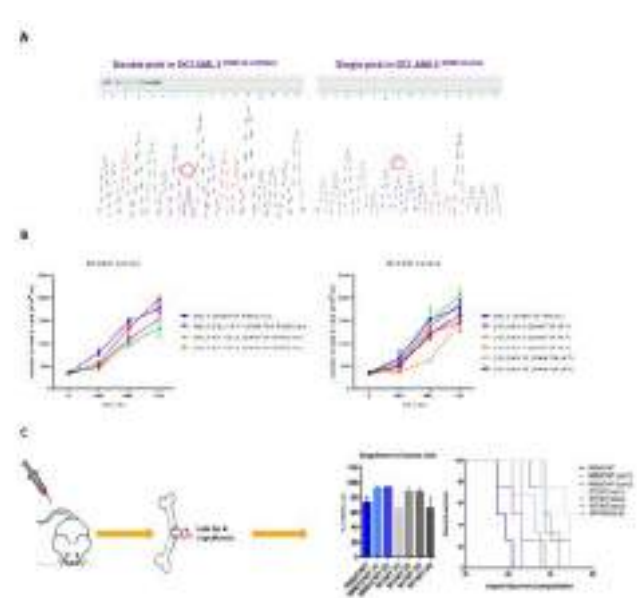

Figure 1.

**Methods:** CRISPR-based genome editing was used to correct the DNMT3A-mutated gene in OCI-AML3 cell line harbouring DNMT3AR882C mutation and NPM1 mutation A. Single cell clones (n=7) harbouring homozygous DNMT3A wild-type (OCI-AML3\_DNMT3A<sup>wt/wt</sup>) were isolated, characterized and functionally studied both *in vitro* and *in vivo* and compared to clones (n=3) derived from the parental OCI-AML3 cell line (OCI-AML3\_DNMT3A<sup>wt/R882C</sup>) (Figure 1A). Growth curves, immunophenotypic profiles, colony forming capacity, and engraftment in immunocompromised mice (NSG) were evaluated. Mice inoculated with leukemia were followed-up for survival. Methylation profile was analyzed by whole-genome bisulfite sequencing. Transcriptome was evaluated by RNAseq.

**Results:** OCI-AML3\_DNMT3A<sup>wt/wt</sup> colonies did not show a significant difference in colony formation capacity, growth rate, and engraftment and disease development in NSG mice, as compared to the parental OCI-AML3 (Figure 1 B, C). No significant differences were observed in immunophenotype and intracellular signaling pathways either. As expected, methylation profiles showed that OCI-AML3\_DNMT3A<sup>wt/wt</sup> displayed a significant number of hypermethylated genes as compared to OCI-AML3\_DNMT3A<sup>wt/R882C</sup> ( $p < 0.05$ ), indicating that the methylation rate was at least partially re-established upon the restoration of DNMT3A wild-type. Comparing the transcriptomic profile of the different colonies, we found 213 differentially expressed genes ( $\text{LOG}_2\text{FC} > |1.5|$   $e\text{ padj} < 0.05$ ).

**Conclusions:** These findings suggest that, despite the established role of DNMT3A mutation as driver genetic lesion in AML, AML progression is uncoupled by the influence of DNMT3A mutation once the disease is already established, doubting the role of mutated DNMT3A as therapeutic target in AML. To confirm this hypothesis, we are currently carrying out the same panel of experiments in other cellular models carrying DNMT3A mutations. Extended data will be presented at the national meeting.

## ORAL COMMUNICATIONS

### Acute Leukemias 1

#### C01

#### DEL(17Q) MARKS A SUBGROUP OF IMMATURE HOXA-POSITIVE T-ALL DRIVEN BY SUZ12 INACTIVATION, DEREGLATED CELL CYCLE, AND JAK/STAT AND NOTCH SIGNALING

V. Bardelli<sup>1</sup>, V. Pierini<sup>1</sup>, S. Arniani<sup>1</sup>, E. Mavridou<sup>1</sup>, C. Matteucci<sup>1</sup>, A.G. Lema-Fernandez<sup>1</sup>, M. Moretti<sup>1</sup>, L. Elia<sup>2</sup>, F. Giglio<sup>3</sup>, F. Forghieri<sup>4</sup>, M. Cerrano<sup>5</sup>, N. Fracchiolla<sup>6</sup>, M. Delia<sup>7</sup>, S. Sica<sup>8</sup>, C. Mecucci<sup>1</sup>, R. La Starza<sup>1</sup>

<sup>1</sup>Hematology and Bone Marrow Transplantation Unit, University of Perugia; <sup>2</sup>Hematology, Department of Translational and Precision Medicine, Sapienza University; <sup>3</sup>Hematology and Bone Marrow Transplantation Unit, IRCCS Ospedale San Raffaele; <sup>4</sup>Section of Hematology, Department of Medical and Surgical Sciences, University of Modena and Reggio Emilia; <sup>5</sup>Department of Molecular Biotechnology and Health Sciences, Division of Hematology, University of Turin; <sup>6</sup>Hematology, Fondazione IRCCS Ca' Granda-Ospedale Maggiore Policlinico; <sup>7</sup>Hematology and Stem Cell Transplantation Unit, AOUC Policlinico; <sup>8</sup>Section of Hematology, Department of Radiological and Hematological Sciences, Catholic University of the Sacred Heart

**Introduction:** T-ALL, an heterogeneous subgroup of acute leukemias, result from the accumulation of multiple genetic and epigenetic events concurring to the leukemia phenotype. These alterations affect T-cell transcription factors (Type A)<sup>1</sup> and a large number of genes implicated in different cellular processes. Genomic imbalances, and particularly deletions, are the most frequent cytogenetic rearrangements in T-ALL. Whether cryptic or large in size, they often share a region of loss, known as common deleted region (CDR). The CDR is the region of interest to search for putative suppressor gene(s) that undergo haploinsufficiency or complete inactivation, driving the leukemogenic process. We assessed the incidence, distribution, clinical and molecular features of T-ALL marked by an interstitial deletion of the long arm of chromosome 17, *i.e.* del(17q).

**Patients, materials and methods:** From a series of 444 cases of adult and pediatric T-ALL,<sup>1</sup> we uncovered 30 T-ALL cases with a del(17q) (6,7%). Molecular-cytogenetics, DNA and RNA microarrays, qRT-PCR, and sequencing were applied to outline the genomic background of del(17q) T-ALL cases and pick up distinguishing features. Data analysis was carried out referring to available databases (UCSC, NCBI, Data of Genomic Variants, Biocarta, KEGG, Reactome).

**Results:** Del(17q) T-ALL are associated with adulthood (Chi-square test,  $p < 0,001$ ) and with an immature phenotype (ETP/near-ETP) ( $p = 0,01$ ). Accordingly, deletions of cell cycle genes, *i.e.* *RBI* (37%), *CDKN1B* (30%), and *TP53* (20%), and/or transcription factors, *i.e.* *ETV6* (24%), *WT1* (20%), typically associated with ETP-ALL, are recurrent. Moreover, a high rate of abnormalities of members/modulators of the JAK/STAT (60%) signaling and of the NOTCH pathway (60%), are present. Based on rearrangements of Type A oncogenes,<sup>1</sup> 23% of cases belong to the *HOXA* subgroup (=7) while the large majority remain unclassified (=17; 56%). All del(17q) T-ALL share a 650 kb CDR that invariably involves *SUZ12*, *UTP6*, and *NFI*, which are all expressed at a significantly lower levels than T-ALL without del(17q). In addition, 108 differentially expressed genes (DEG), 43 up- and 65 down-regulated, distinguishes del(17q) T-ALL cases. Among DEG, there are putative oncosuppressors, *i.e.* *BRCA1*, *FANCI*, *BRIPI*, *CHEK1*, and *XRCC4*, and *MAF* and *RUNX2* transcription factors. Cell cycle and pathways related to genomic stability (homologous recombination, DNA replication, and Fanconi anemia) are significantly deregulated.

**Conclusion:** Our study provides evidence that del(17q) identifies a pathogenetic driver mechanism, through the cooperation of *SUZ12* inactivation, JAK/STAT and NOTCH signaling activity, and altered cell cycle, in immature T-ALL of adults. Interestingly, *RUNX2*, a marker of high-risk T-ALL where it promotes chemotaxis, adhesion, and homing

to medullary/extramedullary sites,<sup>2</sup> is aberrantly expressed in this subset of T-ALL.

#### References

1. La Starza R, et al. *J Mol Diagn* 2020
2. Matthijssens F, et al. *JCI* 2021

#### C02

#### SERCA MODULATION COUNTERACTS GLUCOCORTICOID RESISTANCE IN T-ALL

L. Pagliaro<sup>1,2</sup>, L. Moron Dalla Tor<sup>1</sup>, L. Monica<sup>1</sup>, P. Andrei<sup>1</sup>, F. Vento<sup>1</sup>, E. Simoncini<sup>1</sup>, Sabrina Kleissle<sup>3</sup>, M. Neuenschwander<sup>4</sup>, A. Gherli<sup>1</sup>, E. Cerretani<sup>1</sup>, A. D'Antuono<sup>1</sup>, A. Montanaro<sup>1</sup> G. Roti<sup>1,2</sup>

<sup>1</sup>Laboratorio di Ematologia Traslazionale e Chemogenomica (THEC), Dipartimento di Medicina e Chirurgia, Università degli Studi di Parma; <sup>2</sup>Ematologia e CTMO, Azienda Ospedaliero Universitaria di Parma; <sup>3</sup>Max Delbrueck Center for Molecular Medicine in the Helmholtz Association (MDC), Berlin; <sup>4</sup>Leibniz-Forschungsinstitut für Molekulare Pharmakologie (FMP), Berlin

**Introduction:** Targeting addictive oncoproteins, such as *NOTCH1*, is the most desired therapeutic approach for T-cell acute lymphoblastic leukemia (T-ALL). While modulators of the Notch pathway would be expected to have clinical efficacy, their application was limited by an excess of toxicity due to the suppression of wild type (WT) *NOTCH1* proteins. In the past, we identified the  $Ca^{2+}$  pump P-type ATPase SERCA as a gatekeeper of the oncogenic *NOTCH1* signaling. Thapsigargin (Tg), a potent SERCA inhibitor (SI), possesses an anti-*NOTCH1*-leukemia activity both *in vitro* and *in vivo* by preferentially targeting mutated *NOTCH1* proteins over WT ones.

**Methods:** To identify synergistic combinations and avoid resistance to SI, we generated a drug-adapted T-ALL cell line resistant to Tg (ALL/SIL R). Resistant cells displayed a mutation (c.G770T p.Gly257Val) in *ATP2A2* gene occurring between the Asp254-Leu260 in the third SERCA2 transmembrane (TM) helix. This variation impedes an efficient Tg binding to the protein, resulting in a diminished inhibitory effect. Next, we quantified the abundance of differentially expressed (DE) genes ( $P < 0,05$ ) in ALL/SIL and ALL/SIL R by RNA-seq and identified deregulated pathways by intersecting gene set enrichments. In parallel, we screened a small molecule library of nearly 2500 bioactive compounds (from the European Chemical Biology Library provided by EU-OPENSCREEN) in ALL/SIL and ALL/SIL R. Compound hits were flagged by their ability to inhibit each cell line or both. Confirmatory experiments were completed in multiple T-ALL preclinical models.

**Results:** ALL/SIL R showed an increase of Tg  $IC_{50}$  equal to 150-fold and a subtle resistance to a newer SI, CAD204520, that binds SERCA in a different site to the one of Tg. This result suggests that part of the resistance mechanism is transcriptionally mediated and potentially common to several SI. Gene sets analysis of 6241 DE genes revealed an enrichment in pathways related to steroids (*e.g.*, cholesterol and lipid metabolism, response to sterol). In line with this finding, our small molecules screen identified that glucocorticoids (GC) are preferentially active in ALL/SIL R. While naïve cells were resistant to GC, ALL/SIL R cells showed an enhanced sensitivity at low nanomolar concentrations. We tested whether this effect was mediated by a soluble factor and showed that ALL/SIL R conditioned medium failed to restore GC sensitivity in the parental line. Instead, ALL/SIL R cells reestablished the GC receptor expression and activity as shown by western blotting or RU486-based competition assays. Consequently, the association of SI plus GC displayed a synergistic effect in multiple preclinical models, including steroid-resistant cell lines, primary leukemia cells, and PDX models.

**Conclusions:** These findings suggest that SERCA- $Ca^{2+}$  modulation mediates GC and steroid signaling and that innovative SI can pharmacologically modulate glucocorticoid resistance.

## C03

### A "DESIGNED" HIGH THROUGHPUT DRUG SCREENING STRATEGY IDENTIFIES AURORA KINASE A INHIBITORS AS PROMISING PRECLINICAL CANDIDATES FOR THE TREATMENT OF NPM1-MUTATED AML

R. Ranieri<sup>1</sup>, M. Neuenschwander<sup>2</sup>, S. Kleissle<sup>2</sup>, F. Mezzasoma<sup>1</sup>, S. Silvestri<sup>1</sup>, A. Ferrari<sup>1</sup>, S. Pierangeli<sup>1</sup>, S. Donnini<sup>1</sup>, F. Milano<sup>1</sup>, M. Sabino<sup>1</sup>, V. Tini<sup>1</sup>, G. Spinozzi<sup>1</sup>, B. Falini<sup>1</sup>, J.P. von Kries<sup>2</sup>, I. Gionfriddo<sup>1</sup>, M.P. Martelli<sup>1</sup>

<sup>1</sup>Ematologia e Immunologia Clinica, Università di Perugia; <sup>2</sup>Leibniz-Forschungsinstitut für Molekulare Pharmakologie

**Introduction:** Nucleophosmin (NPM1)-mutated acute myeloid leukemia (AML) accounts for one-third of adult AML and displays distinctive biological and clinical features. Despite its chemo-sensitivity and a relatively favourable prognosis, this form of leukemia lacks of a specific therapy. Since NPM1 mutant protein is not druggable, targeting its non-oncogene addictions, and thus the specific vulnerabilities, can represent an alternative option to find a tailored therapy for NPM1-mutated AML. This represents the rationale that prompted us to perform a high-throughput screening (HTS) of different chemical compounds and drugs libraries in order to find drugs or compounds 'synthetically lethal' with NPM1 mutation and/or anyway showing a more selective action in AML with NPM1 mutation.

**Methods:** In collaboration with the Screening unit of Leibniz-Forschungsinstitut für Molekulare Pharmakologie (FMP) (Berlin, Germany), we performed a HTS of 38720 drugs/compounds in 384-well format. The readout of the assay was cellular metabolism/viability by CellTiter Blue (CTB), a metabolism based assay, at 48 hours. The screening was properly designed in 2-step in order to increase efficiency, exclude compounds with general toxicity and identify the compounds ('hits') selectively active against the only two available NPM1-mutated AML cell lines, OCI-AML3 and IMS-M2, and not the wild-type controls.

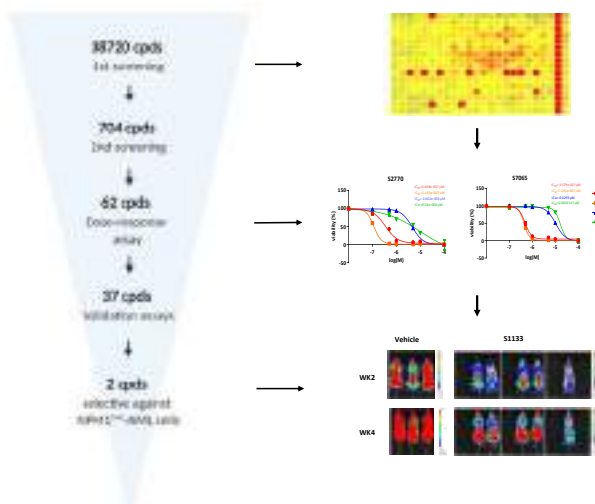

Figure 1.

**Results:** Sixty-two hit compounds that met qHTS threshold criteria were rescreened in a dose-response experiment. From this analysis we obtained 37 compounds able to selectively kill IMS-M2 (IMS-M2 %viability <50 vs OCI-AML2 %viability >75). We focused on Aurora kinase A (AURKA) inhibitors, since 4 of the selective compounds were directed against this kinase. In the validation assay, 2 (MK-5108 and MK-8745) were confirmed more active against NPM1-mutated than NPM1-wild type AML cells by either CyQUANT (a cell number based assay) or AnnexinV-PI apoptosis assay. Strikingly, we confirmed selectivity for other two AURKA inhibitors (Alisertib and ENMD-2076, both isoform-selective inhibitors of AURKA) not included in the screening library. The AURKAi anti-leukemic activity was confirmed also *in vivo*. Indeed, AURKAi were effective *in vivo* in reducing tumor burden in NPM1

mutated patient-derived xenograft (PDX) cells models and provided a survival advantage compared to vehicle treated mice.

**Conclusions:** We demonstrated that using HTS can considerably shorten drug discovery time scales leading to the identification of promising lead compounds. Although AURKA inhibitors have been used in clinical trials for malignancies including AML with disappointing results, a focus on the specific NPM1-mutated AML entity has not been made. Our preliminary data support the idea of exploring the effects of AURKA-inhibitors in the specific setting of AML with NPM1 gene mutation. Studies are ongoing in order to find one or more partner for efficient combinatorial drug treatments to translate in the clinic.

## C04

### PEDIATRIC ACUTE MYELOID LEUKEMIA PATIENT DERIVED XENOGRAFTS: DEVELOPMENT AND CHARACTERIZATION OF PRECLINICAL *IN VIVO* MODELS FOR THE IDENTIFICATION AND TESTING OF NEW THERAPEUTIC APPROACHES

A. Da Ros<sup>1</sup>, V. Indio<sup>2</sup>, E. Porcù<sup>1</sup>, G. Borella<sup>1</sup>, M. Benetton<sup>1</sup>, C. Tregnago<sup>1</sup>, S. Cairo<sup>3-4</sup>, B. Michielotto<sup>1</sup>, S. Bresolin<sup>1</sup>, B. Buldini<sup>1</sup>, A. Pession<sup>5</sup>, F. Locatelli<sup>6-7</sup>, M. Pigazzi<sup>1-4</sup>

<sup>1</sup>Divisione di Emato-Oncologia Pediatrica e Terapia Cellulare e Genica, Dipartimento di Salute della Donna e del Bambino, Università degli Studi di Padova; <sup>2</sup>Centro Interdipartimentale Alma Mater Institute on Healthy Planet, Università di Bologna; <sup>3</sup>XenTech; <sup>4</sup>Istituto di Ricerca Pediatrica- Fondazione Città della Speranza; <sup>5</sup>Dipartimento di Pediatria "Lalla Seragnoli", Unità di Oncoematologia, Università di Bologna; <sup>6</sup>Dipartimento di Oncoematologia Pediatrica, IRCCS Ospedale Pediatrico Bambino Gesù; <sup>7</sup>Dipartimento di Pediatria, Sapienza, Università di Roma

**Introduction:** In pediatric acute myeloid leukemia (AML), chemotherapy is the standard of care, but >30% of patients still relapse. The need to accelerate the evaluation of innovative medicines prompted us to investigate the clonal heterogeneity and evolution of AML by generating robust *in vivo* preclinical models for testing new drugs.

**Methods:** We generated 16 patient derived xenografts (PDXs) from primary AML samples inoculated in NSG mice (namely P0-PDXs) and followed clonal composition for up to 3 consequent passages *in vivo* (namely P1 and P2). We characterized PDXs at immunophenotypic, genomic and transcriptomic levels by RNA and whole-exome sequencing (WES). We tracked clonal dynamics based on somatic mutations sequencing and copy number alterations (CNA). We expanded P3 PDXs and performed personalized drug screenings *in vivo*.

**Results:** AML-PDXs generated reflected 10 different genetic high risk AML subgroups, with conspicuous representation of *KMT2A*-rearranged AML with various partner genes, of *NUP98-NSD1*, *NPM1-MLF1*, *CBFA2T3-GLIS2*, *FLT3-ITD*, and *FUS-ERG* rearrangements. We observed a significant correlation between engraftment and survival of the patients from whom the blasts originated. We monitored the leukemia-associated immunophenotype (LAIP) and found that it was maintained from AML at diagnosis to PDX-AML. By whole exome sequencing we found a consistent number of variants confirming an high intra-tumor heterogeneity and a clonal evolution from patient' AML to P2-PDXs, highlighting novel variants associated to disease progression. We characterized the clonal dynamics identifying the presence of "founder" clones in all the generated models, with an average of 30 variants (at least one known to be a driver gene) being maintained at the same allelic frequency during PDXs passages. Furthermore, several clones subjected to expansion from patient' AML to PDXs have been newly identified. By transcriptomic sequencing analyses we highlighted main pathways perpetuated from AML at diagnosis to P2-PDX allowing to set up a series of novel drug screenings in P3-PDXs expanded models. New drugs, used alone or combined with several known chemotherapeutic (Arabinoside) and biological agents (Venetoclax) are under evaluation for their efficacy in reducing AML burden after engraftment, and in a relapsed *in vivo* model.

**Conclusions:** Finally, we generated a large cohort of paired AML and xenograft models for advancing pediatric AML therapeutics. Our models represent a concrete perspective for both, the identification of new variants/pathways involved in AML progression, and novel drug



screening experimentations for a further generation of a personalized AML drug portfolio.

## C05

### FUSION LANDSCAPE IN ACUTE LEUKEMIAS: A SUBMERGED WORLD OF NOT ROUTINELY CHARACTERIZED TRANSCRIPTS

A. Ferrari<sup>1</sup>, S. Vitali<sup>2</sup>, E. Fonzi<sup>3</sup>, C. Domizio<sup>1</sup>, A. Ghelli Luserna Di Rora<sup>1</sup>, M. Tebaldi<sup>3</sup>, C. Papayannidis<sup>4</sup>, A. Padella<sup>1</sup>, M.T. Bochicchio<sup>1</sup>, G. Marconi<sup>5</sup>, D. Cangini<sup>5</sup>, M.B. Giannini<sup>5</sup>, M. Rondoni<sup>6</sup>, A.M. Mianulli<sup>7</sup>, B. Giannini<sup>8</sup>, F. Giglio<sup>9</sup>, C. Pasciolla<sup>10</sup>, M. Fumagalli<sup>11</sup>, A. Imovilli<sup>12</sup>, M. Endri<sup>13</sup>, S. Galimberti<sup>14</sup>, G. Simonetti<sup>1</sup>, G. Castellani<sup>2</sup>, D. Remondini<sup>2</sup>, D. Calistri<sup>1</sup>, G. Martinelli<sup>15</sup>

<sup>1</sup>Biosciences Laboratory, IRCCS Istituto Romagnolo per lo Studio dei Tumori (IRST) "Dino Amadori", Meldola (FC), Italy; <sup>2</sup>Dipartimento di Fisica e Astronomia, INFN, Università di Bologna, Bologna, Italy; <sup>3</sup>Unit of Biostatistics and Clinical Trials, IRCCS Istituto Romagnolo per lo Studio dei Tumori (IRST) "Dino Amadori", (FC), Italy; <sup>4</sup>IRCCS Azienda Ospedaliero-Universitaria di Bologna, Istituto di Ematologia "Seragnoli" Bologna, Italy; <sup>5</sup>Hematology Unit, IRCCS Istituto Romagnolo per lo Studio dei Tumori (IRST) "Dino Amadori", Meldola (FC), Italy; <sup>6</sup>Hematology Unit & Romagna Transplant Network, Ravenna Hospital, Ravenna, Italy; <sup>7</sup>Hematology, Infermi Hospital, Rimini, Italy; <sup>8</sup>Laboratorio Unico- AUSL della Romagna Pievesestina di Cesena (FC), Italy; <sup>9</sup>Hematology and Bone Marrow Transplantation Unit, IRCCS San Raffaele Scientific Institute, Milan, Italy; <sup>10</sup>Hematology and Bone Marrow Transplantation Unit, Istituto Oncologico IRCCS "Giovanni Paolo II"- Bari, Italy; <sup>11</sup>Hematology Unit, Ospedale San Gerardo, Monza, Italy; <sup>12</sup>Hematology, Azienda USL-IRCCS Reggio Emilia, Emilia-Romagna, Italy; <sup>13</sup>UOC Ematologia Ospedale Ca' Foncello Azienda ULSS 2 Marca Trevigiana, Treviso, Italy; <sup>14</sup>Hematology Unit, AOUP Santa Chiara, Pisa, Italy; <sup>15</sup>Scientific Directorate, IRCCS Istituto Romagnolo per lo Studio dei Tumori (IRST) "Dino Amadori", Meldola (FC), Italy

**Introduction:** Fusions (Fs) are major molecular biological abnormalities in acute leukemias (ALs), and all well-known Fs in leukemias are founder variations are routinely used as molecular markers for the diagnosis, classification, risk stratification, and targeted therapy but there is a considerable part of ALs that are not screened for other known/unknown transcripts. For example In B-Other B Acute Lymphoblastic Leukemia (B-ALL) [Ph-/-; negative for t(9;22); t(1;19); t(4;11); 61% of adult B-ALL], many chimeric genes have been recently identified leading to a refined classification of B-ALL and to, in some cases, tailored therapies. At this point, a RNA-seq approach is needed but challenging for many aspects (genetic complexity, low frequency, cost), among them data analysis. We developed and validated our integrated pipeline in order to assess targetable biomarkers and to better classify patients (pts). **Methods:** we performed 1385 gene RNAseq (Illumina) of 184 adult AL samples (106 Ph-/-, 37 Ph+, 6 t(1;19), 4 B-LBL, 15 T-LBL/T-ALL and 16 AML-R/R). We developed a combined 4 tool analysis that is further implemented with a filtering strategy with a specific ALs fusion literature filter (Patent PCTEP2021-065692) (Figure 1A). We developed a validation strategy using: RT-PCR, FISH SNP Arrays; MLPA and total RNA-seq.

**Results:** From 2587 candidate Fs, we retained 164 of them (6.33%; excluding *BCR-ABL1*, *TCF3-PBX1*, *ETV6-MECOM* and *CBFB-MYH11*) not otherwise detected, in 104 pts with a high Fs rate in T-LBL/T-ALL, Ph-/- and Ph+ (66.6%, 62.3% and 56.8% respectively) denoting that ALs are not deeply characterized (Figure 1B). The lower rate was found in R/R AML (18.8%), but we were able to identify new *ETV6* rearrangement (r) and a FISH cryptic F (*TBL1XR1-MECOM*). We validated 71 Fs that have been already reported in the literature and 23 novel F transcripts. We obtained a validation rate of 95.6%. The majority of fused samples (65.2%) had only one detectable F while a smaller group was characterized by multiple Fs. Many of these Fs were previously described in B/T-ALL and AML (e.g. *KMT2A-MLL1*, *ABL1/2-RCSD1*, *IGH-MYC*, *NUP214-SET*, *ETV6-MECOM* and *CBFB-MYH11*). In our bigger sub-

cohort (Ph-/-), 38 Fs out of 97 (39.2%) were never been reported in Ph- ALL cases. In Ph-like pts, we identified and validate 11 new transcripts (e.g. *TET3-ETV6*, *NUMA1-CSF1R*, *IKZF1-IGKV5*). Ph-/- F detection help to sub-classify our fused pts in Ph-/- subgroups (ZNF384r-11.8%; Ph-like-19.1%; DUX4r- 4.4%; HLFr, MLLr and BCL2/MYC in 2.9%; MEF2Dr-1.5%). Conclusions: we identified pivotal transcripts in all ALs and an unexpected high rate of secondary Fs in some adult ALs subgroups (50-66.6%) that are not characterized with conventional diagnostic methods. The use of an NGS approach and a powerful pipeline permit us to detect Fs useful for a better classification and in some cases to find targetable Fs (e.g. *ABL1/2-RCSD1*, *NUMA1-CSF1R*, *ZMYM2-FLT3*). Supported by: 5x1000- L3P2505, L3P1945/46.

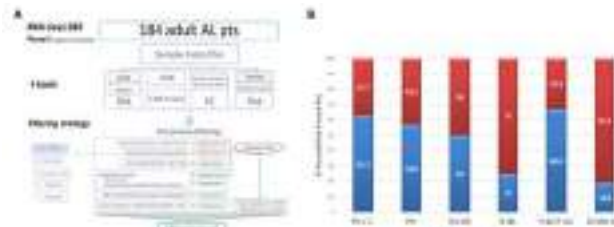

Figure 1.

## C06

ABSTRACT WITHDRAWN

## C07

### INTERFERON-GAMMA-DEPENDENT IDO1 UP-REGULATION IN THE BONE MARROW MICROENVIRONMENT IS ASSOCIATED WITH INCREASED T REGULATORY CELLS AND WORSE CLINICAL OUTCOMES IN ACUTE MYELOID LEUKEMIA PATIENTS

G. Corradi<sup>1</sup>, B. Bassani<sup>2</sup>, G. Simonetti<sup>3</sup>, S. Sangaletti<sup>2</sup>, J. Vadakekolathu<sup>4</sup>, M. Pazzaglia<sup>3</sup>, C. Tripodo<sup>5</sup>, G. Cristiano<sup>1</sup>, L. Bandini<sup>6</sup>, E. Ottaviani<sup>6</sup>, M. Piccioli<sup>6</sup>, G. Martinelli<sup>3</sup>, M.P. Colombo<sup>2</sup>, S. Rutella<sup>4,7</sup>, M. Cavo<sup>1,6</sup>, M. Ciciarello<sup>1,8</sup>, A. Curti<sup>6</sup> \*equal contribution

<sup>1</sup>Dipartimento di Medicina Specialistica, Diagnostica e Sperimentale, Università di Bologna; <sup>2</sup>Fondazione IRCCS, Istituto Nazionale dei Tumori; <sup>3</sup>IRCCS Istituto Romagnolo per lo Studio dei Tumori "Dino Amadori"; <sup>4</sup>John van Geest Cancer Research Centre, College of Science and Technology, Nottingham Trent University; <sup>5</sup>Tumor Immunology Unit, Department of Health Sciences, University of Palermo; <sup>6</sup>IRCCS Azienda Ospedaliero-Universitaria di Bologna, Istituto di Ematologia "Seragnoli"; <sup>7</sup>Centre for Health, Ageing and Understanding Disease (CHAUD), Nottingham Trent University Clifton Campus; <sup>8</sup>CNR Institute of Molecular Genetics "Luigi Luca Cavalli-Sforza", Unit of Bologna

**Introduction:** Along with hematopoietic stem cell-intrinsic alterations, recent evidence highlighted the pathogenetic role of the immunosuppressive BM microenvironment in acute myeloid leukemia (AML). AML cells provide signals modulating the BM microenvironment. Among those signals, interferon (IFN)-gamma is well-known to confer the immuno-suppressive capacity to mesenchymal stromal cells (MSCs), BM niche elements harnessing the AML immune-tolerant microenvironment. In this AML-protecting scenario, T regulatory cells (Tregs) play a pivotal role, contributing to chemoresistance and relapse. A crucial mediator of MSC-driven Treg induction is indoleamine 2,3-dioxygenase 1 (IDO1), a well-known tryptophan metabolizing enzyme. We have demonstrated that AML cells express IDO1. Recently, we found that IDO1 expression in the AML immune microenvironment identifies a novel IDO1-based gene signature predictive of worse clinical outcomes in AML. This work investigated an IDO1-centered mechanism favoring Treg expansion in the AML BM microenvironment, potentially influencing clinical outcomes.

**Methods:** AML patients' BM aspirates were subdivided according to IFNG expression. Gene expression profiles (GEP) in INFGhigh and IFNGlow samples were compared and used to compute a prognostic index (PI) applied to TCGA AML cases. BM microenvironment remodeling was investigated in MSC/AML cell co-cultures. In mice, AML cells silenced for IFN- $\gamma$  expression were injected intrabone w/w/o IDO1 inhibitor.

**Results:** Genome-wide and immune-targeted GEP revealed in INFGhigh AML samples an upregulation of inflammatory genes, usually correlated with a good prognosis in cancer. By contrast, survival analysis showed that AML patients with PI above the median had significantly shorter overall survival than those below the median. Interestingly, the percentages of activated BM Tregs, retaining suppressive activity among Treg subsets, were higher in INFGhigh than in IFNGlow samples and positively correlated with IFN- $\gamma$ + AML cells. In co-culture experiments, INFGhigh AML cells modified MSC transcriptome by up-regulating Treg recruitment and differentiation genes, including IDO1. IDO1 inhibitor abolished the effect of IFN- $\gamma$  release by AML cells on MSC-driven Treg conversion. Mice injected with IFN- $\gamma$ -silenced cells showed a decreased BM Treg frequency associated with lower engraftment. BM Treg decrease was paralleled by a significantly lower IDO1 expression, also in MSCs. Similar results were observed in human biopsies. Consistently, the administration of an IDO1 inhibitor to mice inoculated with IFN- $\gamma$  expressing cells reduced Tregs expressing CTLA-4, a well-known immune suppressor.

**Conclusion:** Our results showed that IFN- $\gamma$  produced by AML cells reshapes the BM microenvironment toward an IDO1-dependent Treg increase. Overall, this study unravels an IDO1-dependent tolerogenic mechanism that might impact clinical outcomes, informing the delivery of novel therapies targeting the AML microenvironment (e.g., IDO1 blockade).

## C08

### CLONAL HEMATOPOIESIS AS A RISK FACTOR FOR THERAPY-RELATED MYELOID NEOPLASMS IN PATIENTS WITH CHRONIC LYMPHOCYTIC LEUKEMIA TREATED WITH CHEMO-(IMMUNO)THERAPY

E. Fabiani<sup>1,2\*</sup>, T. Pandzic<sup>3,4\*</sup>, G. Falconi<sup>1</sup>, M. Denčić-Fekete<sup>5</sup>, E. De Bellis<sup>1</sup>, L. Scarfo<sup>6</sup>, V. Ljungström<sup>3,4</sup>, M. Iskas<sup>7</sup>, G. Del Poeta<sup>1</sup>, P. Ranghetti<sup>6</sup>, S. Laidou<sup>8</sup>, A. Cristiano<sup>1</sup>, K. Plevova<sup>9,10</sup>, S. Imbergamo<sup>11</sup>, M. Engvall<sup>3,4</sup>, A. Zucchetto<sup>12</sup>, C. Salvetti<sup>13</sup>, F.R. Mauro<sup>14</sup>, N. Stavroyianni<sup>7</sup>, L. Cavalier<sup>3,4</sup>, P. Ghia<sup>6</sup>, K. Stamatoopoulos<sup>8,15</sup>, P. Baliakas<sup>3,4\*</sup>, M.T. Voso<sup>1\*</sup>

<sup>1</sup>Department of Biomedicine and Prevention, University of Tor Vergata, Rome, Italy; <sup>2</sup>UniCamillus-Saint Camillus International University of Health Sciences, Rome, Italy; <sup>3</sup>Department of Immunology, Genetics and Pathology, Science for Life Laboratory, Uppsala University, Sweden; <sup>4</sup>Department of Clinical Genetics, Uppsala University Hospital, Uppsala, Sweden; <sup>5</sup>Clinic for Hematology, Clinical Center of Serbia, Belgrade, Serbia; <sup>6</sup>Strategic Research Program in CLL, Division of Experimental Oncology, IRCCS Ospedale San Raffaele and Università Vita-Salute San Raffaele, Milan, Italy; <sup>7</sup>Hematology Department and HCT Unit, G. Papanicolaou Hospital, Thessaloniki, Greece; <sup>8</sup>Institute of Applied Biosciences, Center for Research and Technology Hellas, Thessaloniki, Greece; <sup>9</sup>Central European Institute of Technology (CEITEC), Masaryk University, Brno, Czech Republic; <sup>10</sup>Department of Internal Medicine – Hematology and Oncology, University Hospital Brno & Medical Faculty, Masaryk University, Brno, Czech Republic; <sup>11</sup>Hematology and Clinical Immunology, Department of Hematology, Hospital of Padua, Italy; <sup>12</sup>Clinical and Experimental Onco-Hematology Unit, Centro di Riferimento Oncologico di Aviano (CRO), IRCCS Aviano, Italy; <sup>13</sup>Division of Hematology, University of Turin, Italy; <sup>14</sup>Department of Translational and Precision Medicine, Hematology, 'Sapienza' University, Rome, Italy; <sup>15</sup>Department of Molecular Medicine and Surgery, Karolinska Institutet, Stockholm, Sweden

**Introduction:** Therapy-related myeloid neoplasms (t-MN) include acute myeloid leukemia (AML), myelodysplastic syndromes (MDS) and myelodysplastic/myeloproliferative neoplasm (MDS/MPN) arising in

patients treated with chemo- and/or radio-therapy for a previous tumor or an autoimmune disease.

Chronic lymphocytic leukemia (CLL) is a malignancy of mature B cells characterized by increased risk for other malignancies, in particular the hematological type after the fludarabine/cyclophosphamide/rituximab regimen (FCR), actually associated with a risk up to 5-9% for the development of t-MN. In the context of t-MN, clonal hematopoiesis of indeterminate potential (CHIP), has been shown to be present at the time of the primary cancer diagnosis in 30-70% of patients, representing a pre-malignant state, which can be further triggered by the exposure to cytotoxic agents. CHIP may predispose for the development of t-MN.

**Methods:** The study included 15 patients with CLL who developed a MN (13 after the administration of FCR), a population-based cohort of 285 sequential CLL patients and, as a control, 5 CLL patients FCR treated who did not develop t-MN. Targeted deep-sequencing (t-NGS) was performed in all diagnostic samples (n=305). In CLL patients who developed a t-MN, variants detected at the t-MN diagnosis were backtracked in samples from the CLL phase, as such as, for CLL patients who did not develop a t-MN after FCR treatment. In cases where the variants were undetectable by sequencing, digital droplet PCR was performed.

**Results:** Using NGS, we detected a total of 30 pathogenic/likely pathogenic (P/LP) variants in 10 of 13 patients with a t-MN (77%, median number of variants for patient: 2, range 0-6). The prevalence of CHIP was then backtracked in paired samples taken at CLL diagnosis in 8 of these patients. Six of them carried at least one CHIP-variant at the time of t-MN (median: 2, range: 1-5), and the same variants were present at the CLL phase in 5 cases. As a control, we studied a population-based CLL cohort (n=285 patients), and found CHIP-variants in 35 patients. The prevalence of CHIP was significantly higher in patients with a CLL who developed a t-MN, compared to the control cohort (5/8, 62.5% vs 35/285, 12%, p=0.0001, Figure 1). Clonal evolution overtime in patients with CLL treated with FCR who did not develop a t-MN (n=5) was also studied. In 2 of these patients, t-NGS did not detect any P/LP variant at any time point, while two patients harbored P/LP variants in SF3B1 and TP53 genes, whose VAF followed the disease evolution and response to treatment. Interestingly, a NRAS variant onset after the administration of FCR was detected in one patient, at a VAF of 42% 6 years after treatment.

**Conclusions:** Our data show that CHIP may be considered as a novel parameter affecting treatment algorithms in patients with CLL, and address towards the use of chemo-free therapies in CHIP-positive cases.

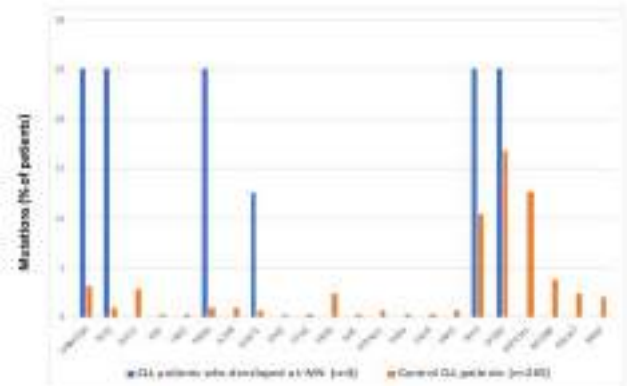

Figure 1.

## Chronic Myeloproliferative Disorders 1

### C09

#### INTEGRATION OF MULTIPARAMETER FLOW CYTOMETRY SCORE IMPROVES PROGNOSTIC STRATIFICATION PROVIDED BY STANDARD MODELS IN MYELOFIBROSIS

F. Mannelli<sup>1</sup>, S. Bencini<sup>2</sup>, G. Coltro<sup>1</sup>, G. Loscocco<sup>1</sup>, B. Peruzzi<sup>2</sup>, G. Rotunno<sup>1</sup>, C. Maccari<sup>1</sup>, F. Gesullo<sup>1</sup>, M. Borella<sup>1</sup>, C. Paoli<sup>1</sup>, R. Caporale<sup>2</sup>, C. Mannarelli<sup>1</sup>, F. Annunziato<sup>2</sup>, A.M. Vannucchi<sup>1</sup>, P. Guglielmelli<sup>1</sup>

<sup>1</sup>SOD Ematologia, Centro Ricerca e Innovazione Malattie Mieloproliferative (CRIMM), AOU Careggi, Università di Firenze; <sup>2</sup>Centro Diagnostico di Citofluorimetria e Immunoterapia, AOU Careggi, Italy

**Introduction:** According to 2016 WHO classification, myelofibrosis (MF) is included within myeloproliferative neoplasms (MPN) and is characterized by a hematopoietic clonal proliferation often associated with bone marrow fibrosis. As a reference to facilitate therapeutic choices, prognostic modeling has pursued the identification of meaningful parameters and their integration to separate categories with different outcome. Modern stratification has included, aside clinical and hematological variables, genetic data from karyotype to driver and other mutations. However, some poorly standardized variables are still included in main models, potentially affecting pt categorization and decision making. Among these, peripheral blood (PB) blast count is based on morphology and as such burdened by intrinsic variability. In this study, we used multi-parameter flow cytometry (MFC) with the aim of improving current prognostic stratification.

**Methods:** We interrogated our database for pts with MF diagnosis and available MFC files for PB CD34+ cell count carried out at diagnosis or during follow-up. Ogata phenotypic score, previously validated by ELN in MDS, was adapted to MF context and included 2 parameters: a) absolute count ( $\mu\text{L}$ ) of CD34+ cells; b) granulocytes to lymphocytes SSC ratio. Pts were annotated for driver and high-risk mutations.

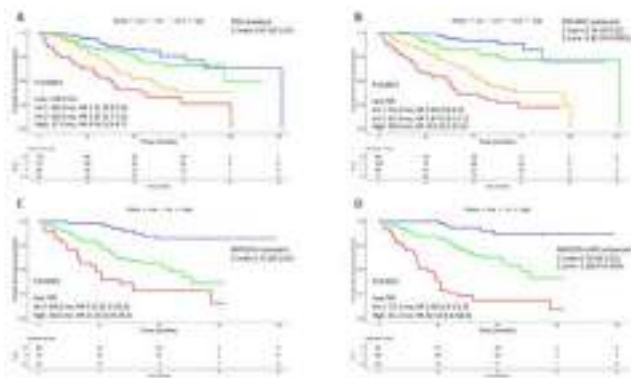

Figure 1.

**Results:** From 1995 to 2020 we enrolled 378 pts; 15 of them were excluded because showed a CD34+ cell count > 5% of WBC, consistent with upfront accelerated or blast phase. Three-hundred-fifty-seven driver mutations were found in 347 (95.6%) patients: JAK2 V617F in 245 (67.5%), 50 in CALR (type 1, 13.8%), 25 in CALR (type 2, 6.9%) and 18 in MPL (5.0%). Ten patients harbored two concomitant driver mutations; 16 (4.4%) patients were triple-negative. In the MFC model, a score of 1 was attributed for each above-threshold values of the parameters: absolute CD34+ cells and SSC ratio. Thereby we grouped pts as MFClow (score=0, n=225, 62.0%), MFCint (score=1, n=107, 29.5%) or MFChigh (score=2, n=31, 8.5%). MFClow had significantly longer OS (median not reached) compared to MFCint (55 months, HR 2.90) and MFChigh (19 months, HR 11.91). We integrated MFC into established stratification models as a substitute to the assessment of PB blasts by morphology.

The pts were reclassified according to MFC-enhanced scores, and concordance (C-) index was calculated and compared. As regards IPSS, C-indexes were 0.67 and 0.74 for standard and MFC-enhanced model, respectively (Z score -3.82; P=0.0001) (Figure 1A-B). In PMF pts (n=201), MFC-enhanced MIPSS70+ model yielded a C-index of 0.78 thus outperforming its standard counterpart (C-index 0.73; Z score -2.88, P=0.004) (Figure 1C-D).

**Conclusions:** Our data on a large dataset of MF pts suggest that the incorporation of MFC-derived parameters, easily attainable from standard assays used for CD34+ cell determination, might help refine the current prognostic stratification and hence the clinical decision algorithm.

### C10

#### RESCUE OF SETD2 TUMOR SUPPRESSOR FUNCTIONS IS A NOVEL MECHANISM OF ACTION OF MIDOSTAURIN IN SYSTEMIC MASTOCYTOSIS (SM) AND MAY SERVE AS A BIOMARKER OF RESPONSE

C. Monaldi<sup>1</sup>, M. Mancini<sup>2</sup>, S. De Santis<sup>1</sup>, M. Rondoni<sup>3</sup>, S. Bruno<sup>1</sup>, C. Papayannidis<sup>2</sup>, C. Sartor<sup>1</sup>, M. Cavo<sup>1,2</sup>, S. Soverini<sup>1</sup>

<sup>1</sup>Department of Experimental Diagnostic and Specialty Medicine - DIMES, Institute of Hematology "L. e A. Seràgnoli", University of Bologna; <sup>2</sup>IRCCS Azienda Ospedaliero-Universitaria di Bologna, Istituto di Ematologia "Seràgnoli"; <sup>3</sup>Azienda USL della Romagna, Italy

**Introduction:** We have previously reported that the loss of function of the histone methyltransferase-encoding SETD2 tumor suppressor is a frequent event cooperating with KIT tyrosine kinase (TK) activation in advanced SM (advSM). Midostaurin is currently the only TK inhibitor approved by EMA for the treatment of advSM. However, biomarkers for prediction of response in patients (pts) treated with midostaurin are lacking. In this study, we aimed to dissect the mechanisms of action of midostaurin in SM and identify novel biomarkers of response.

**Methods:** Studies were conducted in the HMC-1 mast cell leukemia cell line (displaying SETD2 loss of function due to reduced protein stability) and in primary neoplastic MCs from SM pts. Western Blotting (WB) was used to evaluate protein expression and activity.

**Results:** By WB, we found that Aurora kinase A (AKA) is overexpressed and activated in advSM and demonstrated, using RNAi and pharmacological inhibition with danusertib, that AKA is implicated in SETD2 proteasomal degradation. As a multikinase inhibitor, midostaurin targets several other kinases beyond KIT, including AKA. We thus hypothesized that AKA inhibition and subsequent SETD2 rescue may represent an additional mechanism of action of midostaurin, synergizing with KIT TK inhibition in advSM. To this purpose, HMC-1 cells were treated with 5 $\mu\text{M}$  midostaurin for 24h, and phospho-AKA (T288), SETD2, and H3K36 trimethylation (H3K36me3; surrogate marker of SETD2 activity) were evaluated by WB. Midostaurin indeed reduced AKA phosphorylation by 60%, partially restoring SETD2 expression and activity. We next wondered whether the same happens in pts treated with midostaurin. We thus performed WB analysis on neoplastic MCs from 10 advSM pts before and during midostaurin treatment. We found that midostaurin may target AKA and rescue SETD2 expression and function in-vivo too. Interestingly, SETD2/H3K36me3 rescue correlated with the clinical response to midostaurin and with the reduction of KIT D816V allele burden as assessed by digital PCR at 3, 6 and 12 months of treatment. Indeed, SETD2/H3K36me3 rescue was observed as early as at 3 months after treatment onset in 8 pts who responded to midostaurin, whereas 2 refractory pts did not show any increase in SETD2/H3K36me3 and maintained an unaltered KIT D816V allele burden. Finally, we assessed the prognostic value of SETD2 and H3K36me3 levels in the context of other relevant clinical and laboratory variables, and found that reduced SETD2 and H3K36me3 correlated with significantly shorter overall survival in a series of 88 pts with various forms of SM analyzed by WB.

**Conclusions:** AKA inhibition resulting in rescue of SETD2 expression and function is an additional mechanism of action of midostaurin both *in vitro* and *in vivo* in SM. SETD2 and H3K36me3 levels by WB may serve as biomarkers of response to midostaurin and should be further explored as novel prognostic factors. Supported by AIRC IG 2019 (23001).

**C11**

**SCREENING FOR HEREDITARY ALPHA-TRYPTESEMIA IN SUBJECTS WITH SYSTEMIC MASTOCYTOSIS AND NON-SM MAST CELL ACTIVATION SYMPTOMS**

F. Irushani Vanderwert<sup>1</sup>, B. Sordi<sup>1</sup>, F. Mannelli<sup>1</sup>, B. Palterer<sup>2</sup>, F. Gesullo<sup>1</sup>, V. Mecheri<sup>2</sup>, R. Santi<sup>3</sup>, C. Mannarelli<sup>1</sup>, F. Crupi<sup>1</sup>, R. Zanotti<sup>4</sup>, F.I. Grifoni<sup>5</sup>, C. Elena<sup>6</sup>, R. Parente<sup>7</sup>, M. Triggiani<sup>8</sup>, L. Pieri<sup>9</sup>, F. Almerigogna<sup>2</sup>, P. Guglielmelli<sup>1</sup> A.M. Vannucchi<sup>1</sup>

<sup>1</sup>CRIMM, Center Research and Innovation of Myeloproliferative Neoplasms, University of Florence, AOU Careggi; <sup>2</sup>University of Florence, AOU Carreggi, Immunoallergology Unit; <sup>3</sup>AOU Careggi, Hemopathology Unit; <sup>4</sup>Section of Haematology, Department of Medicine, Verona University Hospital; <sup>5</sup>BMT Center - Hematology Unit, Fondazione IRCCS Ca' Granda Ospedale Maggiore Policlinico - University of Milan; <sup>6</sup>Department of Molecular Medicine and Department of Hematology Oncology, University of Pavia & IRCCS Policlinico S. Matteo Foundation; <sup>7</sup>Division of Allergy and Clinical Immunology, Department of Medicine, University of Salerno; <sup>8</sup>Division of Allergy and Clinical Immunology, University of Salerno; <sup>9</sup>AOU Careggi, Center Hemorrhagic Diseases, Florence, Italy

**Introduction:** Hereditary alpha-Tryptasemia (HαT), characterized by a mild elevation in serum tryptase levels and mast cell (MC) activation symptoms, is defined by increased copy number of *TPSAB1* gene encoding for both α- and β-alleles. This copy number variation (CNV) on one or both alleles is the genetic base of HαT (Lyons *et al.* 2018). It has been suggested that HαT might be a germline variant predisposing to Systemic Mastocytosis (SM) development (Greiner *et al.* 2021). In SM, HαT correlated with a higher incidence of mediator-related symptoms. Due to its complexity, the assay for *TPSAB1* CNV is performed in a few centers. We screened 347 samples, 47 pts (cohort 1) with MC activation symptoms and no evidence of SM and 300 pts with a diagnosis of WHO 2016 SM (cohort 2).

**Methods:** Droplet digital PCR (ddPCR) was used to measure CNVs in *TPSAB1* adapting the standard protocol to genotype for both *TPSAB1* and *TPSB2* (Figure 1A). High homology between α and β encoding isoforms and the paralogous genes in the same locus makes *TPSAB1* CNV detection very challenging. ddPCR was performed on gDNA with/without *BamHI*, using the PrimePCR ddPCR Copy Number reference *AP3B1* (BioRad). Accuracy and precision of the protocol were assessed by analyzing 10 samples in triplicate in 3 separate experiments.

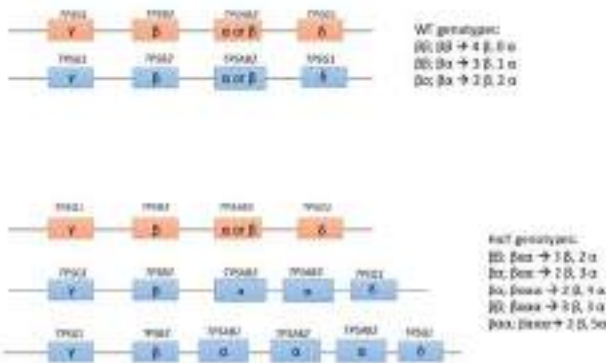

**Figure 1. Combinations of possible genotypes for *TPSB2* and *TPSAB1*.**

**Results:** HαT was documented in 63.8% of subjects in cohort 1, and 13.1% in cohort 2. BST threshold for cohort 1 was ≤ 11 mcg/L (median: 15.3); 29% had history of anaphylaxis. In cohort 2, 89.3% pts had a diagnosis of SM, whereas 8,6% had Cutaneous Mastocytosis (CM). Among SM patients, 113 presented with non-advanced SM variants. Advanced forms including aggressive SM (ASM) and SM with associated hematological neoplasm (SM-AHN) were diagnosed in 6 and 8 respectively; 41.7% had history of anaphylaxis. HαT+ pts in cohort 1 presented significantly higher BST (17.1 vs 12.05 mcg/L, P<0.001); however, occurrence of mediator-related symptoms was comparable to

HαT wt, 72% vs 71.4%, as for anaphylaxis (28% in HαT+ vs 33%). In cohort 2, BST levels were 24.6 in HαT+ and 24.3 mcg/L in HαT wt pts, as were anaphylaxis episodes (50% and 41%). A trend for lower MC burden in HαT+ was demonstrated (% of bone marrow MC: 0.01% in HαT+ vs 0.07%) while no meaningful differences emerged for symptom burden. A lower prevalence of *KIT* D816V mutation was observed in HαT+ (71.4% vs 89.5%; p=0.073). Clinical feature and their correlations with the HαT genotype are collecting and final results will be presented at the conference.

**Conclusions:** In our study, HαT+ was observed in 13% of pts with SM, a prevalence lower than previously reported (Greiner *et al.* 2021) and much lower than cohort1 (64%). ddPCR is a suitable method to investigate the presence of CNV in the α-tryptase coding sequence. Genetic testing for HαT+ should be considered in the diagnostic workout of pts with anaphylaxis or MC mediator-related symptoms and no suspicion/evidence of SM.

**C12**

**IRF4 GENE EXPRESSION IS LOW IN PHILADELPHIA NEGATIVE MYELOPROLIFERATIVE NEOPLASMS AND IS ASSOCIATED WITH A WORSE PROGNOSIS**

C. Cumbo<sup>1</sup>, F. Tarantini<sup>1</sup>, L. Anelli<sup>1</sup>, A. Zagaria<sup>1</sup>, I. Redavid<sup>1</sup>, C.F. Minervini<sup>1</sup>, N. Coccaro<sup>1</sup>, G. Tota<sup>1</sup>, A. Ricco<sup>1</sup>, E. Parciante<sup>1</sup>, M.R. Conserva<sup>1</sup>, G. Specchia<sup>2</sup>, P. Musto<sup>1</sup>, F. Albano<sup>1</sup>

<sup>1</sup>Department of Emergency and Organ Transplantation (D.E.T.O.) - Hematology and Stem Cell Transplantation Unit - University of Bari "Aldo Moro"; <sup>2</sup>School of Medicine, University of Bari "Aldo Moro"

**Introduction:** Interferon regulatory factor 4 (IRF4) is involved in the pathogenesis of various hematologic malignancies. Its expression has been related to the negative regulation of myeloid-derived suppressor cells and the polarization of M2 macrophages, thereby altering immunosurveillance and inflammatory mechanisms. An abnormal inflammatory status in the bone marrow (BM) microenvironment of myeloproliferative neoplasms (MPNs) has recently been demonstrated. In chronic myeloid leukemia a downregulated expression of IRF4 has been found, and recent evidence supports its prognostic role in JAK2V617F mutated MPNs.

**Methods:** In this context, we evaluated the IRF4 expression in 119 newly diagnosed consecutive Philadelphia negative MPNs (Ph- MPNs) [20 polycythemia vera (PV), 40 essential thrombocythemia (ET), 35 primary myelofibrosis (PMF), and 23 secondary myelofibrosis (SMF)] and correlated its dysregulation with clinical outcome. At the disease onset, a droplet digital PCR gene expression assay was performed on BM samples. The quantification was calculated as the ratio between IRF4 and GUSB number of copies (I/G).

**Results:** The BM IRF4 median value was 0.11 I/G (min. 0.11- max. 0.12) and 0.04 I/G (min. 0.001 – max. 0.27) in the healthy controls (HC) and in the MPNs groups, respectively (p<0.0001). In particular, the PMF patients showed a lower IRF4 median value than the other groups compared to the HC. CALR mutated cases showed a higher IRF4 expression than those with JAK2 (0.06 vs 0.03, p=0.007) or triple-negative (TN) (0.06 I/G vs 0.02 I/G, p=0.0008). Fourteen (11.7%) patients showed leukemic transformation (LT): they had a lower IRF4 expression at diagnosis compared to the other MPN patients (0.01 I/G vs 0.04 I/G, p=0.0005). An optimal cutoff of the IRF4 expression value best identifying the possibility of LT was defined by ROC analysis. The area under the curve was 0.79 (95% CI 0.71–0.86; p<0.0001). An optimal value of 0.022 I/G was obtained, with a sensitivity of 76.9% (95% CI 46.2 – 95.0) and a specificity of 76.1% (95% CI 66.9 – 84.0). MPN patients with an IRF4 value <0.022 I/G had shorter leukemia-free survival (LFS). Overall survival (OS) analysis in the MF group showed that patients with IRF4 >0.022 I/G had longer median survival than those in the <0.022 I/G group (143.9 mo. versus 40.5 mo., p=0.04). Also, the IRF4 value >0.022 I/G was associated with a longer OS (75 mo versus 21 mo, p=0.04). Moreover, PV and ET patients with an IRF4 value <0.022 I/G showed a shorter time to MF transformation (109 mo. versus 190 mo., p=0.03).

**Conclusions:** Overall, our study demonstrates an IRF4 dysregulated expression in MPNs patients, particularly in PMF and JAK2+ and TN+ cases, distinguishing those with a higher probability of SMF. Furthermore, the IRF4 expression was associated with LT and a shorter LFS.

Further studies could validate these data to confirm this biomarker as a new prognostic factor.

### C13

#### APPLICATION OF NEXT-GENERATION SEQUENCING TECHNOLOGY FOR MOLECULAR-BASED RISK SCORE SYSTEMS (MIPSS70 AND MIPSS70+) CALCULATION IN TRANSPLANTED MYELOFIBROSIS PATIENTS

A. Civini<sup>1</sup>, S. Salmoiraghi<sup>1</sup>, F. Patriarca<sup>2</sup>, C. Pavoni<sup>1</sup>, M.C. Finazzi<sup>1</sup>, P. Guglielmelli<sup>3</sup>, D. Russo<sup>4</sup>, E. Rumi<sup>5</sup>, M. Musso<sup>6</sup>, A. Imovilli<sup>7</sup>, O. Spinelli<sup>1</sup>, A. Rambaldi<sup>1,8</sup>

<sup>1</sup>ASST Papa Giovanni XXIII, Ematologia e Trapianto di Midollo Osseo; <sup>2</sup>AOU Santa Maria della Misericordia, Clinica Ematologica; <sup>3</sup>AOU Careggi, TMO Ematologia; <sup>4</sup>AO Spedali Civili, USD - TMO Adulti; <sup>5</sup>Policlinico S. Matteo, Ematologia e TMO; <sup>6</sup>La Maddalena, UO Oncematologia e TMO; <sup>7</sup>Arcispedale S. Maria Nuova, Ematologia; <sup>8</sup>Dipartimento di Oncologia e di Ematologia, Università degli studi di Milano, Italy

**Introduction:** Allogeneic Hematopoietic Stem Cells Transplantation (allo-HSCT) is the only available curative option for Myelofibrosis (MF), but the transplant related mortality (NRM) limits its indication only to high-risk patients. The definition of risk has changed over time and different scores have been developed. Recently, MIPSS70 and MIPSS70+ scoring systems, incorporating the prognostic role of high-molecular risk mutation/s (HMR) (*i.e.* ASXL1, EZH2, SRSF2, IDH1/2), have been developed. Here we present the retrospective evaluation of disease risk according to the MIPSS70s and DIPSS scores of patients who underwent allo-HSCT during the last years.

**Patients and Methods:** In this study, we included 47 patients who underwent HSCT after being classified as intermediate or high risk according to DIPSS. Pre-transplant DNA samples from all these patients were massively sequenced by Illumina MiniSeq platform. We analyzed a subset of 30 genes involved in myeloid leukemogenesis by applying SOPHiA GENETICS™ Myeloid Solution to assess molecular risk classification.

**Results:** According to the DIPSS classification, 33%, 64%, 2% of patients were respectively classified as low/Intermediate-I, Intermediate-II, high-risk. By NGS analysis, we identified a total of 117 mutations, including non-synonymous point mutations (n=86), small insertions or deletions (n=28) and splicing sites mutations (n=3). Almost 60% of patients carried at least one HMR mutation while 11% of the patients had two or more HMR lesions. Based on these molecular data, we redefined the clinical risk of our cohort by MIPSS70 and MIPSS70+ scoring systems. The molecular scores changed the categorization of patients selected for transplantation as follows: 3% low, 25% intermediate and 72% high-risk group by MIPSS70 and 9% low, 6% intermediate, 50% high and 35% very high-risk class by MIPSS70+. Altogether, a higher proportion of patients were defined as high/very high risk, while a very slight number were re-classified as low risk by MIPSS70 scores. As expected, patients classified as high/very high-risk according to the MIPSS70s scores had a higher risk of disease progression and death compared to the low and intermediate risk groups, even though a significant cure rate was demonstrated also in these unfavorable clinical subgroups.

**Conclusions:** Molecular profiling of MF patients is crucial for an appropriate patients indication to transplant at early stage of disease. Our preliminary data suggest that, despite the presence of HMR, HSCT can lead to a significant clinical benefit.

### C14

#### PROGNOSTIC ROLE OF NEUTROPHIL TO PLATELET RATIO (NPR) AND NEUTROPHIL TO LYMPHOCYTE RATIO (NLR) IN PATIENTS AFFECTED BY PRIMARY MYELOFIBROSIS TREATED WITH RUXOLITINIB: A MULTI-CENTER EXPERIENCE

B. Garibaldi<sup>1</sup>, A. Romano<sup>1,2</sup>, A. Duminuco<sup>1</sup>, U. Markovic<sup>1</sup>, M.P. Lizio<sup>1</sup>, S. Frazzetto<sup>1</sup>, E. Lambusta<sup>1</sup>, F. Di Raimondo<sup>1,2</sup>, S. Verstovsek<sup>3</sup>, L. Masarova<sup>3</sup>, G.A. Palumbo<sup>1,3</sup>

<sup>1</sup>U.O.C Ematologia, Azienda Policlinico-Rodolico San Marco; <sup>2</sup>Dipartimento di Specialità Medico-Chirurgiche, CHIRMED, Sezione di Ematologia, Università degli Studi di Catania; <sup>3</sup>Department of Leukemia, The University of Texas MD Anderson Cancer Center; <sup>4</sup>Dipartimento di Scienze Mediche Chirurgiche e Tecnologie Avanzate “G.F. Ingrassia”, Università degli Studi di Catania

In primary myelofibrosis (PMF) the ratio between absolute neutrophils count (ANC) and absolute lymphocyte count (ALC), called NLR, can mirror the inflammatory status and the myeloid associated immune suppression. The ratio between ANC and absolute platelets count, called NPR, is an emerging biomarker of chronic inflammatory status, rarely tested in cancer. The objective is to test NLR=6 and NPR=100 as predictor of response to ruxolitinib (RUX) in PMF. We retrospectively evaluated a training set (#1) including 107 MF patients from MD Anderson Cancer Center treated with RUX on phase 1/2 clinical trial from 2007 to 2010; and validation set (#2) including 109 patients treated on a single Italian Center between years 2012–2020. Spleen responses to RUX treatment, transformation to acute myeloid leukemia (AML) and OS were independently validated in cohorts #1 and 2. NLR and NPR were calculated using data obtained from the complete blood count before RUX start and correlated with driver mutations and clinical outcome. In both cohorts we found that NLR was higher in patients carrying grade 2-3 bone marrow fibrosis, carrying JAK2 (V617F) mutation and lower in CALR (exon 9 indel) mutated patients, associated to spleen response. The mean percentage change from baseline in palpable spleen length, was 61% (95% CI -69 -52) at week 12 and -67% (95% CI -75 -59) at week 24. Patients with NLR>6 before RUX start had a lower chance to obtain a complete resolution of splenomegaly at 24 weeks (p<0.002). The median of neutrophil to platelet ratio (NPR) was 37.2 and 28.5 respectively in cohorts 1 and 2. In the training set, NPR was higher in patients older than 65 years (p=0.04), carrying JAK2V617F mutation (p=0.001), high JAK2 allele burden in JAK2 mutated patients (p=0.001), CALR exon 9 indel (p=0.03). NPR was progressively higher in progressively increasing DIPSS stage (p=0.04). In univariate analysis, in the training set, predictors of overall survival were high JAK2V617F allele burden (p=0.03), achievement of spleen response with at least clinical improvement (p=0.02), platelets count>450,000/uL (p=0.0006) and NPR <100 (p=0.0001). In multivariate analysis, JAK2V617F allele burden (p=0.003), platelets count>450,000/uL (p=0.0005) and NPR <100 (p=0.03) were independent predictors of overall survival in PMF patients treated with RUX. These observations were confirmed in the validation set, since platelets count >450,000/uL (p=0.04) and NPR <100 (p=0.0007) were predictors of OS in univariate analysis, thus we concluded that in both sets only NPR>100 was associated to inferior outcome. NLR and NPR are positively correlated with JAK2 and CALR mutations before RUX start and could serve as a useful, simple and early predictors of spleen response in MF patients. NPR >100 could identify a small fraction of patients (10-30%) with poor outcome despite treatment with RUXO.

### C15

#### EFFICACY AND SAFETY OF AVAPRITINIB IN PATIENTS WITH ADVANCED SYSTEMIC MASTOCYTOSIS: POOLED RESULTS FROM THE PHASE 1 EXPLORER AND INTERIM PHASE 2 PATHFINDER STUDIES

A.M. Vannucchi<sup>1</sup>, D. Radia<sup>2</sup>, D. DeAngelo<sup>3</sup>, M. Deininger<sup>4</sup>, A. Reiter<sup>5</sup>, H.M. Lin<sup>6</sup>, S. Dimitrijević<sup>6</sup>, J. Gotlib<sup>7</sup>

<sup>1</sup>Center for Research and Innovation of Myeloproliferative Neoplasms – CRIMM, University of Florence, Azienda Ospedaliera Universitaria Careggi; <sup>2</sup>Guy's & St Thomas' NHS Foundation Trust; <sup>3</sup>Department of

*Medical Oncology, Dana-Farber Cancer Institute;* <sup>4</sup>*Division of Hematology and Hematologic Malignancies, University of Utah, Huntsman Cancer Institute;* <sup>5</sup>*Department of Hematology and Oncology, University Hospital Mannheim, Heidelberg University;* <sup>6</sup>*Blueprint Medicines Corporation;* <sup>7</sup>*Division of Hematology, Stanford Cancer Institute/Stanford University School of Medicine*

**Introduction:** Systemic mastocytosis (SM), a clonal hematologic neoplasm driven by a *KIT* D816V mutation in ~95% of cases, has limited treatment options. We evaluated pooled efficacy and safety of avapritinib, an orally administered selective inhibitor of D816V-mutant *KIT*, in patients with advanced SM (AdvSM) from the phase 1 EXPLORER (NCT02561988) and interim analysis of the phase 2 PATHFINDER (NCT03580655) studies.

**Methods:** Patients in this *post hoc* pooled analysis were ≥18 years old with centrally confirmed diagnosis of AdvSM and treated with once-daily (QD) avapritinib at starting doses ≤200 mg. Overall response rate (ORR) was defined as complete remission with full (CR) or partial (CRh) hematologic recovery, partial remission (PR), or clinical improvement, per mIWG-MRT-ECNM criteria. Other analyses included overall survival (OS), progression-free survival (PFS), duration of response (DOR), changes from baseline in mast cell disease burden, and safety. The data cut-off date for this analysis was May 27, 2020, for EXPLORER and June 23, 2020, for PATHFINDER.

**Results:** Efficacy was analyzed in 53 ORR-evaluable patients treated with avapritinib starting doses ≤200 mg QD, regardless of prior therapy; median age was 67 years (range, 37–85), 32% had an ECOG PS of 2–3, 66% had prior antineoplastic therapy, 47% received prior midostaurin, and 94% had a *KIT* D816V mutation. The ORR was 72% (95% CI, 58–83), with 28% achieving a CR/CRh (95% CI, 17–42) and 57% (95% CI, 42–70) with a PR or better (Table 1).

**Table 1. ORR by mIWG-MRT-ECNM response criteria.**

Best confirmed central response, n (%)	All ORR-evaluable (n=53)	ASM (n=2)	SM-AHN (n=40)	MCL (n=11)	Prior antineoplastic therapy		S/A/R mutation positive	
					Yes (n=35)	No (n=18)	Yes (n=26)	No (n=27)
ORR (CR+CRh+PR+CI)	38 (72)	2 (100)	31 (78)	5 (45)	24 (69)	14 (78)	18 (69)	20 (74)
CR or CRh	15 (28)	1 (50)	13 (33)	1 (9)	8 (23)	7 (39)	8 (31)	7 (26)
CR	3 (6)	0	2 (5)	1 (9)	2 (6)	1 (6)	1 (4)	2 (7)
CRh	12 (23)	1 (50)	11 (28)	0	6 (17)	6 (33)	7 (27)	5 (19)
PR	15 (28)	1 (50)	10 (25)	4 (36)	9 (26)	6 (33)	5 (19)	10 (37)
CI	8 (15)	0	8 (20)	0	7 (20)	1 (6)	5 (19)	3 (11)
SD	10 (19)	0	5 (13)	5 (45)	6 (17)	4 (22)	4 (15)	6 (22)
PD	1 (2)	0	0	1 (9)	1 (3)	0	0	1 (4)
Not evaluable	4 (8)	0	4 (10)	0	4 (11)	0	4 (15)	0

ASM, aggressive systemic mastocytosis; CI, clinical improvement; CR, complete remission; CRh, CR with partial hematologic recovery; MCL, mast cell leukemia; mIWG-MRT-ECNM, modified International Working Group-Myeloproliferative Neoplasms Research and Treatment & European Competence Network on Mastocytosis; ORR, overall response rate; PD, progressive disease; PR, partial remission; S/A/R, *SRSF2/ASXL1/RUNX1*; SD, stable disease; SM-AHN, systemic mastocytosis with associated hematological neoplasm.

Median DOR was 38.3 months (95% CI, 21.7–NE) with responses deepening over time. Median time to response and to CR/CRh was 1.9 months (range, 0.3–26.7) and 9.2 months (range, 1.8–37.9). Median OS was 46.9 months (95% CI, 46.9–NE); the estimated 12-month OS rate was 84%. Median PFS was 40.3 months (95% CI, 23.0–NE). Patients achieved ≥50% reductions from baseline in serum tryptase (49/53, 92%), marrow mast cell aggregates (46/52, 88%), and blood *KIT* D816V allele fraction (37/52, 71%), and ≥35% reductions in spleen volume (38/53, 72%). In all patients with AdvSM (safety population) receiving a starting avapritinib dose of 200 mg (n=80), common non-hematologic AEs (any grade; Grade ≥3) were edema (79%; 5%), diarrhea (28%; 1%), nausea

(24%; 1%), and fatigue/asthenia (23%; 4%); decreased platelets (64%; 21%), hemoglobin (55%; 23%), and neutrophils (54%; 25%) from baseline were the most common lab abnormalities. Median follow-up was 7.9 months (95% CI, 6.8–9.0). Overall, 8 (10%) patients permanently discontinued treatment due to AEs, 4 (5%) patients due to drug-related AEs, and 6 (8%) due to disease progression. Median time to first dose reduction due to AEs was 6.9 weeks. Of 2 (3%) AE-related deaths, neither were treatment-related.

**Conclusions:** Pooled study results showed ≤200 mg QD avapritinib induced rapid (1.9 months), deepening and sustained (38.3 months) clinical responses and had a generally well-tolerated safety profile in patients with AdvSM.

## C16

### COMPREHENSIVE ANALYSIS OF STRUCTURAL VARIANTS IN TRIPLE NEGATIVE MYELOFIBROSIS PATIENTS USING A NANOPORE-BASED SEQUENCING ASSAY

S. Romagnoli<sup>1</sup>, N. Bartalucci<sup>1</sup>, C. Maccari<sup>1</sup>, F. Pancani<sup>1</sup>, L. Signori<sup>1</sup>, G. Rotunno<sup>1</sup>, C. Paoli<sup>1</sup>, A. Atanasio<sup>1</sup>, A. Vannucchi<sup>1</sup>, P. Guglielmelli<sup>1</sup>

<sup>1</sup>*Center Research and Innovation of Myeloproliferative Neoplasms, Azienda Ospedaliera Universitaria Careggi, University of Florence, Italy*

**Introduction:** Among the myeloproliferative neoplasms (MPNs), approximately 10–15% of myelofibrosis (MF) cases still lack a driver mutation (point mutations in *JAK2*, *MPL* and *CALR*) and are therefore defined as triple-negative (TN). To address such clinical and pathological need, we analyzed the genome of TN patients by the long-read sequencing technology Oxford Nanopore Technology (ONT) with the aim to identify new molecular abnormalities responsible for the development of a MPN phenotype. Long-read sequencing technology proved invaluable to identify previously intractable DNA sequences as well as unravel previously undetected structural variants (SVs). SVs are defined as genomic alterations larger than 50 bp in size including insertions, deletions, duplications, inversions and translocations. The identification of new possible disease-causing SVs in TN-MPNs cases could contribute to elucidate the molecular mechanism underlying MPN and provide new molecular markers potentially refining the management of such category of patients.

**Methods:** The study cohort included paired germinal (CD3<sup>+</sup> cells) and somatic (CD34<sup>+</sup> cells) samples at diagnosis from 9 TN MF patients (2 Post-Essential Thrombocythemia MF, PET-MF, and 7 PMF). The Genomic DNA purified from samples was used for the library preparation and run on PromethION sequencer. Sequencing data were real-time basecalled by ONT proprietary software (v20.06.18) and variant calling was performed by Sniffles and cuteSV. SVs detected by both callers were further selected for a number of supporting reads ≥ 5 and excluding those present also in the germline counterpart.

**Results:** The mean coverage across the cohort was 12X (range: 8.3X–18X) and the median number of SVs per sample resulted 320. A total of 3170 SVs was found, of which 1747 were insertions (55.11%), 1386 deletions (43.72%), 13 inversions (0.41%), 19 duplications (0.6%) and 5 translocations (0.17%). Overall, 2724 SVs (86%) represented private abnormalities, while the 14% were found in at least two patients. Interestingly, we found a 414bp insertion in chromosome 12p25.1 (median allele fraction of 100%) and a 346bp deletion in chromosome 3q29 (median allele fraction of 100%) that recurred in 6 (2 PET-MF and 4 PMF) and 5 patients (1 PET-MF and 4 PMF), respectively. Four patients (36%) resulted mutated for both SVs. No significant differences were found in SVs-positive patients in term of age, white and red blood cell count, hemoglobin, hematocrit and LDH level, nevertheless sequencing and clinical data analysis and correlation are still ongoing to characterize the significance of the reported genomic abnormalities.

**Conclusion:** Despite such observations need to be validated in larger cohorts of patients, current results support the potential of the long-read genome-wide analysis for the identification of novel SVs that may have relevance in the pathophysiology and diagnosis of TN MPNs.

## Plasma Cell Dyscrasias 1

### C17

#### DESIGN AND VALIDATION OF A CUSTOM NGS TARGETED PANEL, MM-UMA (UNIQUE MOLECULAR ASSAY)-PANEL, TO IDENTIFY GENOMIC ABNORMALITIES IN MULTIPLE MYELOMA PATIENTS: INTRA-LABORATORY VALIDATION

B. Taurisano<sup>1,2</sup>, M. Martello<sup>1</sup>, A. Poletti<sup>1,2</sup>, B. Ziccheddu<sup>3,4</sup>, G. Mazzocchetti<sup>1,2</sup>, V. Solli<sup>1,2</sup>, E. Borsi<sup>1</sup>, I. Vigliotta<sup>1</sup>, S. Armuzzi<sup>1,2</sup>, I. Pistis<sup>1</sup>, E. Zamagni<sup>1,2</sup>, I. Rizzello<sup>1,2</sup>, L. Pantani<sup>1,2</sup>, S. Rocchi<sup>1,2</sup>, P. Tacchetti<sup>1,2</sup>, K. Mancuso<sup>1,2</sup>, M. Cavo<sup>1,2</sup>, N. Bolli<sup>3,4</sup>, C. Terragna<sup>1</sup>

<sup>1</sup>RCCS Azienda Ospedaliero-Universitaria di Bologna, Istituto di Ematologia "Seràgnoli"; <sup>2</sup>Dipartimento di Medicina Specialistica, Diagnostica e Sperimentale, Università di Bologna; <sup>3</sup>Ca' Granda Ospedale Maggiore Policlinico; <sup>4</sup>Oncology, University of Milan, Italy

**Introduction:** Most of Multiple Myeloma (MM) genetic alterations, such as IgH translocations (t-IgH) and Copy Number Alterations (CNAs), are detected by FISH in the daily practice. However, by analyzing one alteration at a time, FISH returns a partial picture of patients' (pts) genomic landscape. To get a wider view of pts' genomic alterations, we developed a Next Generation Sequencing (NGS) targeted panel, named MM-UMA-panel, able to screen in a single assay the mutational profile of 83 MM-relevant genes, all t-IgH and a genome-wide CNAs profile.

**Methods:** A cohort of 76 MM pts, with FISH data, were profiled by MM-UMA-panel (total footprint: 395 Kbps) on MiSeq (Illumina). The panel robustness was tested by inter- and intra-run validations and by the inclusion of 4 healthy donors DNA (negative controls). Structural aberrations and small nucleotide variants (SNVs) were analyzed by searching for a concordance between the following bioinformatic tools: Delly and Manta (t-IgH), CNVkit and CopywriteR (CNAs), Varscan, Mutect and Freebayes tools (SNVs).

**Results:** Several technical NGS parameters have been optimized thanks to the intra-laboratory validation tests; in particular, a median of 4,3M reads (range: 3,8M–4,9M) was estimated sufficient to confidently call both t-IgH (minimum: 5 reads) and SNVs (clonality >10%), ensuring enough off target reads to call CNAs (median of 64%, range: 60 - 75%). Moreover, the inclusion of intra- and inter-run replicates highlighted high results' reproducibility across the experiments (correlation parameters between intra- and inter run SNVs VAF =  $R > 0.95$ ,  $p < 0.001$ ). Panel performances were also validated by comparing NGS and FISH results (Figure 1).



Figure 1.

Overall, both t-IgH and CNAs results, as detected by NGS and FISH, had good negative and positive concordances, with an overall concordance of 97.2% (range: 94.7-100%). Discordances were mainly attributable to the low off target quality, which did not allow to confidentially call sub-clonal CNAs. Interestingly, MM-UMA-panel called few additional alterations, not detected by FISH: t(11;14) in one pt and t(14;20) and t(6;14), both in another one. According to the revised risk stratification (R-ISS) model, the panel identified 17/76 (22%) pts carrying high risk Cytogenetic Alterations (CA), with an additional pt carrying both del(17p) and t(4;14); on the contrary, 46/76 (60.5%) pts had standard risk CA (Figure 1). Finally, a total of 233 SNVs were identified, the most mutated genes being KRAS (14/76 = 18,4%), NRAS (14/76 = 18,4%), ATM (13/76 = 17,1%), IGLL5 (11/76 = 14,5%) and SETD2 (7/76 = 9,2%).

**Conclusion:** MM-UMA-panel represents a smart and highly informative solution to rapidly obtain genome-wide pts' profiles, to be used to assess pts' risk in a personalized-medicine perspective. The panel's implementation in the daily clinical practice requires additional inter-laboratory validation, already planned in the next months, and cost-effectiveness analysis.

**Acknowledgment:** AIRC\_IG22059

### C18

#### HUMORAL AND CELLULAR IMMUNE RESPONSES FOLLOWING SARS-COV-2 MRNA VACCINATION IN PATIENTS WITH MONOCLONAL GAMMOPATHIES AT DIFFERENT STAGES OF DISEASE

P. Storti<sup>1</sup>, R. Vescovini<sup>1</sup>, V. Marchica<sup>1</sup>, V. Franceschi<sup>2</sup>, V. Raimondi<sup>1</sup>, N. Soressi<sup>3</sup>, B. Dalla Palma<sup>3</sup>, L. Notarfranchi<sup>1,3</sup>, F. Falcioni<sup>3</sup>, M. Giaimo<sup>1,3</sup>, F. Costa<sup>1</sup>, D. Toscani<sup>1</sup>, J. Burroughs Garcia<sup>1</sup>, G. Donofrio<sup>2</sup>, N. Giuliani<sup>1,3</sup>

<sup>1</sup>Dipartimento di Medicina e Chirurgia, Università di Parma; <sup>2</sup>Dipartimento di Scienze Medico Veterinarie, Università di Parma; <sup>3</sup>Ematologia e CTMO, Azienda Ospedaliero-Universitaria di Parma, Italy

**Introduction:** Patients with monoclonal gammopathies share several immunological defects that make them more susceptible to the infections with a reduced response to vaccination in those with multiple myeloma (MM). Currently, SARS-CoV-2 vaccination is the main strategy to prevent clinical adverse outcome of COVID-19. However, recent papers highlighted that vaccinated MM patients have lower specific anti-SARS-CoV-2 humoral response compared to the controls, however both humoral and spike-specific T cell responses to anti-SARS-CoV-2 vaccines in patients with monoclonal gammopathies at different stage of disease are unknown and were investigated in this study.

**Methods:** We enrolled 38 COVID-naïve patients with monoclonal gammopathies including 6 monoclonal gammopathies of undetermined significance (MGUS), 10 smoldering myeloma (SMM), 9 newly diagnosed MM (NDMM) and 13 relapsed MM (MMR). Peripheral blood (PB) samples were collected before the first dose and 14±2 days after the second dose of the BNT162b2 vaccine. SARS-CoV-2 spike IgG antibodies (Abs) were measured by the COVID-SeroIndex Kantaro SARS-CoV-2 IgG test. The fraction of neutralizing Abs against SARS-CoV-2 spike of Wuhan original strain and four variants (alpha, beta, gamma, and delta) was assessed in the collected sera by a SARS-CoV-2 pseudovirus neutralization assay. Finally, the collected PB-mononuclear cells were stimulated, with overlapping peptides pools spanning SARS-CoV-2 spike glycoprotein and SARS-CoV-2 spike-specific CD4<sup>+</sup> and CD8<sup>+</sup> T cells were identified by intracellular cytokine staining for Interferon-gamma (IFN-γ), interleukin-2 (IL-2), tumor necrosis factor-alpha (TNF-α), and CD107a using flow cytometry assay.

**Results:** The seropositivity rate for SARS-CoV-2 spike IgG Abs in the total cohort was 84.2% with 15.8% patients exhibiting no detectable Abs. We found that MMR patients had significantly lower SARS-CoV-2 spike IgG Abs and neutralizing Abs compared with MGUS, SMM and NDMM patients. SARS-CoV-2 spike IgG Abs significantly positively correlates with neutralizing Abs not only against Wuhan original strain but also against all the analyzed variants. We observed a different spike-specific CD4<sup>+</sup> T cell response percentage in MGUS (100%), SMM (75%), NDMM (77.7%) and MMR (58.3%) patients. We found that both SMM and NDMM patients had significantly reduced spike-specific IL-2<sup>+</sup>CD4<sup>+</sup> T cell responses compared to MGUS patients. The percentages of patients with a CD8<sup>+</sup> T cell response were 100%, 75%, 55.5% and 91.6% in MGUS, SMM, NDMM and MMR patients respectively. Finally, we did not find any correlation between spike-specific CD4<sup>+</sup> or CD8<sup>+</sup> T cells responses and SARS-CoV-2 spike IgG Abs levels.

**Conclusion:** MMR patients showed a reduced production of SARS-CoV-2 spike IgG Abs and neutralizing Abs compared to MGUS, SMM and NDMM. On the other hand, SARS-CoV-2 spike-specific T cell responses was highly variable in the cohort of patients and not correlated with the humoral responses.

**C19****COMBINED LENALIDOMIDE AND CK1ALPHA INACTIVATION: IS IT A RATIONALE THERAPEUTIC STRATEGY TO COUNTERACT THE OSTEOGENIC DIFFERENTIATION IMPAIRMENT IN MULTIPLE MYELOMA ASSOCIATED BONE DISEASE?**

A. Fregnani<sup>1,2</sup>, L. Saggin<sup>2</sup>, L. Quotti Tubi<sup>1,2</sup>, M. Pesavento<sup>2</sup>,  
G. Barilà<sup>1,2</sup>, S. Vedovato<sup>1</sup>, R. Zambello<sup>1,2</sup>, N. Giuliani<sup>3</sup>,  
G. Semenzato<sup>1,2</sup>, L. Trentin<sup>1,2</sup>, S. Manni<sup>1</sup>, F. Piazza<sup>1,2</sup>

<sup>1</sup>Department of Medicine, Hematology and Clinical Immunology Branch, University of Padova; <sup>2</sup>Veneto Institute of Molecular Medicine; <sup>3</sup>Department of Medicine and Surgery, University of Parma

**Introduction:** Multiple myeloma (MM) is a malignant plasma cell (PC) neoplasm which displays pathological bone involvement. The bone marrow (BM) microenvironment sustains the MM associated bone disease (MMABD) characterized by impaired bone homeostasis. The Wnt/ $\beta$ -catenin pathway plays a critical role on the potential of mesenchymal stromal cell (MSC) differentiation towards osteoblastic lineage, directly stimulating *RUNX2*, the master gene regulator of the process. Interestingly, the inhibitory effect of MM cells on osteoblastogenesis appears to be mediated by their capability to inhibit *RUNX2* expression in MSC. Protein kinase CK1 $\alpha$  is a Ser/Thr kinase that negatively regulates the Wnt/ $\beta$ -catenin pathway. We have demonstrated that CK1 $\alpha$  inhibition/silencing causes MM cells apoptosis and cell cycle arrest. Our preliminary data showed that CK1 $\alpha$  silencing in MSC induces an osteogenic transcriptional program through the  $\beta$ -catenin stabilization. Lenalidomide (Lena), an immune modulating drug used in MM therapy, acts by a novel mechanism-modulating Cereblon E3 ubiquitin ligase, inducing the degradation of Ikaros, Aiolos and CK1 $\alpha$ , leading to MM cells death. However, Lena effects on MSC osteogenic differentiation is still debated and controversial.

**Methods:** We generated an MM INA-6 cell clone bearing an IPTG-inducible CK1 $\alpha$  directed shRNA. To recreate the BM microenvironment, we plated INA-6 MM cells on a layer of MSC-hTERT stromal cells and the CK1 $\alpha$  silencing was achieved in MM cells. We collected primary MSC from a cohort of 20 patients according to the principles of the Helsinki declaration and written informed consents. Lena treatment in cell culture was performed with different concentrations and time points. We evaluated the expression of CK1 $\alpha$  and of the osteogenic markers by RT-qPCR and WB analysis.

**Results:** Lena treatment caused CK1 $\alpha$  degradation in the MSC hTERT cell line without affecting cell viability and cell cycle. Unexpectedly, the expression of both *RUNX2* and *ALP* mRNA after Lena treatment were reduced in the MSC hTERT cell line and in primary MSC. Indeed, we observed a trend towards a reduction of the osteogenic markers at each stage of the disease, except for SMM that presented a higher level of biological variability. In the co-culture model, CK1 $\alpha$  silencing in MM cells caused a reduction of PC *RUNX2* expression, potentially favoring the stromal differentiation towards the osteoblastic lineage. Lena treatment up-regulated *RUNX2* mRNA expression in MM cells and down regulated it in the MSC counterpart. Surprisingly, CK1 $\alpha$  silencing in MM cells reduced the *RUNX2* upregulation induced by Lena in MM cells and, at the same time, rescued the *RUNX2* expression in the MSC compartment.

**Conclusion:** Our data point to a complex role of Lena since it antagonizes the osteogenic transcriptional program. However, a specific CK1 $\alpha$  silencing in MM cells could counteract the undesirable effects of Lena on the osteogenic differentiation potential, likely ameliorating MMABD.

**C20****CXCL12/CXCR4 AXIS DRIVES MITOCHONDRIAL TRAFFICKING IN TUMOR MYELOMA MICROENVIRONMENT**

I. Dulcamare<sup>2</sup>, C. Giallongo<sup>1</sup>, D. Tibullo<sup>3</sup>, V. Del Fabro<sup>2</sup>, N. Vicario<sup>4</sup>,  
N. Parrinello<sup>2</sup>, A. Romano<sup>5</sup>, G. Scandura<sup>2</sup>, G. Lazzarino<sup>6</sup>,  
C. Conticello<sup>2</sup>, G. Li Volti<sup>3</sup>, M. Amorini<sup>2</sup>, G. Musumeci<sup>7</sup>,  
M. Di Rosa<sup>7</sup>, F. Polito<sup>8</sup>, R. Oter<sup>8</sup>, M. Aguenouz<sup>8</sup>, R. Parenti<sup>4</sup>,  
F. Di Raimondo<sup>5</sup>, G.A. Palumbo<sup>1</sup>

<sup>1</sup>Department of Medical, Surgical Sciences and Advanced Technologies G.F. Ingrassia, University of Catania; <sup>2</sup>Division of Hematology, AOU

Policlinico, Catania; <sup>3</sup>Department of Biomedical and Biotechnological Sciences, Section of Biochemistry, University of Catania; <sup>4</sup>Department of Biomedical and Biotechnological Sciences, Section of Physiology, University of Catania; <sup>5</sup>Department of General Surgery and Medical-Surgical Specialties, University of Catania; <sup>6</sup>UniCamillus - Saint Camillus International University of Health Sciences, Roma; <sup>7</sup>Department of Biomedical and Biotechnological Sciences, Human, Histology and Movement Science Section, University of Catania; <sup>8</sup>Department of Clinical and Experimental Medicine, University of Messina, Italy

**Introduction:** Mesenchymal stromal cells (MSCs) promote tumor growth, confer chemoresistance and support metabolic needs of multiple myeloma plasma cells (MM-PCs) also transferring mitochondria. In this scenario, heterocellular communication and dysregulation of critical signaling axes are among the major contributors to progression and treatment failure. Methods: Metabolic analysis were performed by HPLC. Flow cytometry, immunofluorescence and operetta platform were used to evaluate mitochondrial transfer.

**Results:** As metabolic rewiring is involved in the regulation of MSC phenotype, we first analyzed metabolic profile MM-MSCs and healthy controls. MM-MSCs showed a glycolytic profile, associated to a decreased mitochondrial mass as compared to healthy MSCs and increased tendency to deliver mitochondria to MM cells, suggesting that this intercellular exchange between PCs and MSCs can be considered part of their pro-tumorigenic phenotype. We also found that MM-MSCs showed a significantly up-regulated CXCL12 whose expression can be regulated by CX43, a critical protein for mitochondrial transfer. Therefore, we first evaluated whether MM cells were able to increase the levels of both CXCL12 and CX43 in healthy MSCs. A significant increase of CXCL12-CX43 colocalization was observed. Exposition to ioxynil octanoate (IO), a selective inhibitor of CX43, reverted the up-regulation of CXCL12 induced by MM cells and was able to inhibit mitochondrial transfer. Therefore, we supposed that CXCL12 and its receptor CXCR4 could regulate mitochondria trafficking. We analyzed the kinetic of mitochondria uptake of several HMCLs and related their CXCR4 expression with the percentage of transferred mitochondria, observing a positive correlation, also confirmed in primary myeloma PCs. Furthermore, plerixafor, a selective inhibitor of CXCR4, significantly reduced mitochondrial transfer from MSCs to myeloma PCs. Next, we found that the proteasome inhibitors promoted mitochondrial transfer while their combination with plerixafor inhibited mitochondrial trafficking. Moreover, intracellular expression of CXCR4 in myeloma PCs from BM biopsy specimens demonstrated higher CXCR4 colocalization with CD138+ cells of non-responder patients to bortezomib compared with responder patients.

**Conclusion:** Our data demonstrated that CXCL12/CXCR4 axis mediates intercellular coupling thus suggesting that the myeloma niche may be exploited as a target to improve new therapeutic approaches.

**C21****DISSECTING THE ROLES OF LNCRNA IN MULTIPLE MYELOMA: GENERATION OF A MYELOMA CELL LINE TRANSACTIVATING THE LNCRNA NEAT1 BY CRISPR-CAS9 SYNERGISTIC ACTIVATOR STRATEGY (SAM)**

N. Puccio<sup>1,2</sup>, C. Bandini<sup>3,4</sup>, V.K. Favasuli<sup>1,2</sup>, I. Silvestris<sup>1,2</sup>,  
S. Erratico<sup>5</sup>, R. Piva<sup>3,4</sup>, Y. Torrente<sup>6</sup>, L. Baldini<sup>1,2</sup>, A. Neri<sup>1,2</sup>,  
E. Taiana<sup>1,2</sup>

<sup>1</sup>Hematology, Fondazione Cà Granda IRCCS Policlinico; <sup>2</sup>Department of Oncology and Hemato-oncology, University of Milan; <sup>3</sup>Department of Molecular Biotechnology and Health Sciences, University of Torino; <sup>4</sup>Città Della Salute e della Scienza Hospital; <sup>5</sup>Novystem Spa; <sup>6</sup>Stem Cell Laboratory, Department of Pathophysiology and Transplantation, Unit of Neurology, Fondazione IRCCS Ca' Granda Ospedale Maggiore Policlinico, Italy

**Introduction:** During the past decades several targeting strategies emerged to assess the functional and molecular role of lncRNAs in cancers. Among the different strategies adopted for loss of function studies, gymnotic delivery of ASO LNA-gapmer resulted to be very efficient for hard to transfect cell lines, such as multiple myeloma (MM) cells.



However, gain of function approaches are essential to shed light on the molecular mechanism underlying the mechanism of action of specific lncRNAs. To this aim, the innovative CRISPR-Cas9 synergistic activator strategy (SAM) allows the induction of gene expression without alteration of the DNA sequence, representing a cutting-edge technique. This approach relies on the use of 1) a catalytically dead Cas9 (dCas9) fused to a transcriptional activator and 2) sgRNAs able to recruit on the gene's transcriptional start site an additional transcriptional activator complex. Here, we adopted this elegant genome editing system to induce the lncRNA NEAT1 transactivation in a MM cell line, thus allowing a deeper functional and molecular characterization of NEAT1 in MM disease.

**Methods:** sgRNAs targeting NEAT1 promoter region were selected from CRISPRi library of Yamazaki T. Sequences were cloned into lenti sgRNA(MS2)\_puro backbone. The ligation mixture was transformed into Stab13 competent cells. Positive clones were identified by Sanger sequencing. High titer lentiviral stocks were produced in 293T cells by co-transfecting expression vectors and packaging vectors. Aliquots of virus, plus polybrene, were used to infect AMO-1 cells. Stable cell lines expressing constructs were maintained under selection by treatment with blasticidin, hygromycin and zeocin once a week. Cas9, p65, NONO and SFPQ protein expression was assessed by Western Blot analysis and specific IF. NEAT1 expression was evaluated by qRT-PCR and specific RNA-FISH.

**Results:** Cas9 and p65 proteins expression in AMO-1 transduced cell line revealed the effectiveness of CRISPR-Cas9 SAM approach. qRT-PCR demonstrated a significantly higher NEAT1 expression levels in AMO-1 N#5 and N#8 clones, compared to relative SCR cells. The NEAT1-specific RNA FISH analysis confirmed qRT-PCR results. Consistently with NEAT1 forced expression, we observed an increased amount of both NONO and SFPQ, essential paraspeckles (PSs) proteins, along with a significant increase of PSs number.

**Conclusions:** CRISPR Cas9 approach offers an unprecedented ability to dissect the role of lncRNAs in multiple myeloma, and the downstream molecular implications related with their de-regulation. We highlighted the CRISPR-Cas9 SAM technique as an affordable and reliable method to induce NEAT1 expression and PSs formation, recapitulating what observed in MM patients. Therefore, this approach could be essential for a better characterization of the functional and molecular role of the deregulated lncRNA NEAT1 and its druggability in MM.

## C22

### SIRT6 MODULATION REVEALS THE SPLICEOSOME AS A SPECIFIC THERAPEUTIC VULNERABILITY IN MULTIPLE MYELOMA

E. Gelli<sup>1</sup>, P. Becherini<sup>2</sup>, D. Soncini<sup>1</sup>, C. Martinuzzi<sup>1</sup>, S. Bruzzone<sup>3</sup>, A. Cagnetta<sup>2</sup>, R.M. Lemoli<sup>1,2</sup>, M. Cea<sup>1,2</sup>

<sup>1</sup>Clinic of Hematology, Department of Internal Medicine (DiMI), University of Genoa; <sup>2</sup>IRCCS Ospedale Policlinico San Martino, Clinic of Haematology; <sup>3</sup>Department of Experimental Medicine, University of Genoa, Italy

**Background:** SIRT6 is a NAD<sup>+</sup> consuming histone deacetylase, belonging to the Sirtuin family, responsible for chromatin inaccessibility with consequent repression of gene transcription. The role of this enzyme in cancer appears to be controversial, acting both as a tumor suppressor and oncogene across different types of malignancies. We previously reported that multiple myeloma (MM) cells exhibit high level of SIRT6 as an adaptive response to their intrinsic genomic instability. Indeed, SIRT6, by down regulating MAPK pathway, results in cell proliferation slowing down, with high levels associated with poor outcome. Here we deeply investigate the role of SIRT6 in MM, focusing on its relationship with the splicing machinery.

**Methods:** Gene set enrichment analysis (GSEA), according with SIRT6 expression was performed on RNA-seq data from CoMMpass dataset. SIRT6 was down-regulated by lentivirus-based approach in MM cell lines, then profiled by gene expression microarray to find de-regulated targets. A panel of MM cell lines and primary CD138+ plasma cells derived from NDMM patients were challenged with increased doses of spliceosome and SIRT6 chemical inhibitors. Mechanisms underlying biological effects of drugs combination were further studied by qPCR

and western blot analyses.

**Results:** A preliminary GSEA analysis revealed an enrichment in splicing-related pathways in MM patients, correlating with SIRT6 expression. Transcriptome analysis of SIRT6-depleted MM cells also suggests a spliceosome perturbation. These data pointed us to test sensitivity of SIRT6 depleted MM cells to direct spliceosome inhibition using a specific modulator, the Sudemycin D6 (SD6). Importantly, both chemical inhibitors and genetic depletion significantly enhanced anti-MM activity of SD6, in cell lines and CD138+ plasma cells derived from MM patients, thus suggesting RNA splicing deregulation as exploitable vulnerability in SIRT6-depleted cells. Recent studies suggest that spliceosome is a therapeutic vulnerability in MYC-driven cancer with its-target genes repressed by SIRT6. In such a scenario we found that while c-Myc oncogene loss resulted in phenotypic resistance, as showed by U266 cell line, its re-expression confirmed the efficacy of our strategy thus supporting MYC as a crucial player for SIRT6-mediated de-regulation of spliceosome components. Ongoing ChIP-Seq data on SIRT6 will help to support the role of MYC-deregulated programs in splicing perturbation observed after SIRT6 depletion in MM cells.

**Conclusions:** Overall, our data provide the evidence that targeting SIRT6 in MM cells results in splicing interference which makes the NAD<sup>+</sup> dependent histone deacetylase-based strategies a promising therapeutic approach to fight MM.

## C23

### HOW TO GUARANTEE THE CORRECT MULTIPLE MYELOMA PATIENTS' CLINICAL STRATIFICATION BY UN-BIASED COPY NUMBER ESTIMATION WITH BOBAFIT

G. Mazzocchetti<sup>1,2</sup>, A. Poletti<sup>1,2</sup>, V. Solli<sup>1,2</sup>, E. Borsi<sup>1</sup>, M. Martello<sup>1</sup>, I. Vigliotta<sup>1</sup>, S. Armuzzi<sup>1,2</sup>, B. Taurisano<sup>1,2</sup>, I. Pistis<sup>1</sup>, E. Zamagni<sup>1,2</sup>, M. Cavo<sup>1,2</sup>, C. Terragna<sup>1</sup>

<sup>1</sup>IRCCS Azienda Ospedaliero-Universitaria di Bologna, Istituto di Ematologia "Seràgnoli"; <sup>2</sup>Dipartimento di Medicina Specialistica, Diagnostica e Sperimentale, Università di Bologna, Bologna, Italy

**Introduction:** The genetic architecture of Multiple Myeloma (MM) is complex and heterogeneous and includes a variety of copy number alterations (CNAs). CNAs affect many chromosomes and are used to stratify patients (pts) into prognostically meaningful subgroups: amp(1q) and del(17p) clearly identify high-risk pts. Thus underlining the importance of a precise detection of these CNAs. However, when molecular approaches are employed to profile patients, computational algorithms might erroneously estimate the "diploid region" (DR), resulting in incorrect CNAs calls and CN profiles definition. This is particularly frequent in highly complex karyotypes, as in MM, and tends to influence the overall CN signals leading to a misinterpreted definition of the DR. In order to check and correct the DRs of data coming from molecular experiments, we have previously developed a bioinformatics tool (*BoBafit*), which has been applied and FISH-validated on MM samples, showing a 3% errors incidence in DR assessment. Here we show our DR correction improves the right CN call of MM clinically relevant CNAs and supports a precise pts' risk stratification, according to the R-ISS guidelines.

**Methods:** 595 MM pts' genomic profiles, obtained by SNPs array experiments at the "Seràgnoli" Institute of Hematology have been included in the present study. We focused on 5 CNAs -amp(1q), del(1p), del(13), del(17p), and Hyperdiploidy (HD)- frequently observed in MM, which have been called at 10% clonality level, except for HD (called at 50% clonality level). Profiles were stratified in either High (CN-HR) or Standard Risk (CN-SR), according to the presence of del(17p), which R-ISS guidelines include among the high-risk defining CNAs. For all analysis, we employed R software.

**Results:** *BoBafit* correction was applied to all genomic profiles included in the study, generating for each pt a pre- and a post-correction profile. Profiles were annotated and stratified in groups, according to the presence of 1 or more CNAs. As expected, most pts profiles remained in the same group pre- and post-correction, as the DR didn't need any correction. However, 157 pts (26,4%) shifted from one group to another, due to the DR correction. In particular, several pts shifted into the HD and amp(1q) groups, suggesting that these CNAs are especially biased (Figure 1). We finally stratified pts according to the presence of del(17p),

both before and after *BoBafit* correction. Overall, 27 pts (4,5%) moved from CN-HR to CN-SR class, highlighting a significant bias in the pts' risk stratification before the DR correction.

**Conclusions:** Overall, in 3% of MM pts an incorrect CNAs profile was highlighted, due to a wrong DR estimation; this caused a bias in CNAs calls and, therefore, in pts' clinical risk assessment. By assuring unbiased CN calls, the implementation of *BoBafit* in all molecular CN pipelines would guarantee a correct pts' stratification, according to the MM risk-assessment guidelines.

**Acknowledgment:** AIRC19-IG22059.

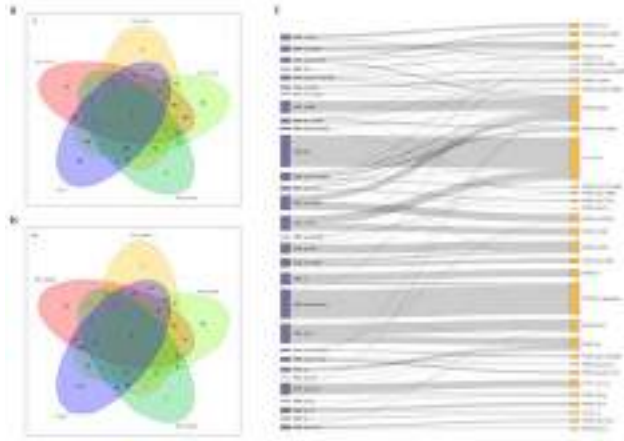

Figure 1.

## C24

### ARGININE STARVATION IN MULTIPLE MYELOMA MICROENVIRONMENT CONVEYS BORTEZOMIB REFRACTORINESS VIA TLR4 PATHWAY

G. Scandura<sup>1</sup>, A. Romano<sup>1</sup>, C. Giallongo<sup>2</sup>, E. La Spina<sup>1</sup>, F. Puglisi<sup>1</sup>, A. Barbato<sup>3</sup>, D. Cambria<sup>1</sup>, M. Amorini<sup>4</sup>, C. Conticello<sup>1</sup>, V. Del Fabro<sup>1</sup>, D. Tibullo<sup>4</sup>, G.A. Palumbo<sup>2</sup>, F. Di Raimondo<sup>1</sup>

<sup>1</sup>Department of General Surgery and Medical-Surgical Specialties, A.O.U. "Policlinico-Vittorio Emanuele"; <sup>2</sup>Department of Medical and Surgical Sciences and Advanced Technologies "G.F. Ingrassia"; <sup>3</sup>Department of Clinical and Experimental Medicine; <sup>4</sup>Section of Biochemistry, Department of Biomedical and Biotechnological Sciences

**Background:** In multiple myeloma (MM) malignant plasma cells (PC) can induce metabolic changes in the local microenvironment that are closely related to drug resistance and disease progression. Arginine (Arg) is a non-essential amino acid which plays an important role in the immune-escape mechanisms and in BTZ resistance. Since our group has previously demonstrated that BTZ-resistant PCs upregulate TLR4 pathway as a stress responsive mechanism, and TLR4-driven cytokine production in starvation is under control of general control nonderepressible 2 (GCN2), a serine/threonine-protein kinase that senses amino acid deficiency through binding to uncharged transfer RNA, we aimed to investigate TLR4 signalling in response to Arg deprivation.

**Methods:** Our *in vitro* studies are carried out on three human myeloma cell lines (HMCLs) (U266, NCI-H929, OPM2) cultured in medium with different Arg concentrations: R100 (114 µg/mL), R25 (28.5 µg/mL) and R10 (11.4 mg/mL), correspondent respectively to 100%, 25% and 10% of the arginine concentration in MM bone marrow, for 24h or 48h. Apoptosis and mitochondrial depolarization were measured by FACS. Protein expression was evaluated by western blot analysis. Gene expression was carried out by qRT-PCR.

**Results:** In BTZ-refractory patients Arg-1 was increased in peripheral blood. Sera of MM, but not MGUS patients, conferred BTZ-resistance to U266 cell line in an Arg-1 dependent manner, an effect partially reverted by treatment with nor-NOHA (an aspecific Arg-1 inhibitor). Treatment with recombinant Arg-1 for 24 hours conferred protection to U266 after 48h treatment with 20nM bortezomib, associated to increased

expression of ASNS, ATF4 and p62. In HMCLs the progressive arginine deprivation induced delay in cell cycle until proliferation arrest (in total lack of arginine in culture media), with increase of G0-G1 length, associated to decreased cell viability starting from R25. We next investigated if MM cells may adapt to Arg deprivation through unfolded protein response (UPR) system or GCN2 pathways. In the UPR system, higher levels of expression of metabolic-stress sensing protein PERK was observed only in NCI-H929 cells adapted to lower Arg deprivation (R25). Interestingly, we found an up-regulation of GCN2 protein expression in U266 cells already at R25 and in NCI-H929 only at R10 condition, associated to increased expression of TLR4 and its downstream effectors, involved in mitochondrial depolarization, suggesting a role of TLR4 pathway in preserving MM-PCs under arginine starvation. We finally tested the efficacy of bortezomib (BTZ) and carfilzomib (CFZ) in HMCLs cultured in R25 and R10 medium. Compared to MM cells treated with PIs in R100 medium, HMCLs exposed to BTZ and CFZ in R25 and R10 medium showed decreased PI-induced apoptosis and lower mitochondrial depolarization.

**Conclusions:** Our study suggests that TLR4 pathway is part of adaptation to Arg deprivation in HMCLs and is involved in conveying bortezomib refractoriness.

## Lymphoproliferative Diseases

### C25

#### EVALUATION OF STAT5B MUTATIONS AND TCR SIGNATURE IN CD4+ T-CELL LARGE GRANULAR LYMPHOCYTE LEUKEMIA

V.R. Gasparini<sup>1,2</sup>, A. Teramo<sup>1,2</sup>, D. Bhattacharya<sup>3,4</sup>, J. Huuhtanen<sup>3,4,5</sup>, J. Theodoropoulos<sup>3,4,5</sup>, G. Schiavoni<sup>6</sup>, G. Barilà<sup>1,2</sup>, C. Vicenzetto<sup>1,2</sup>, G. Calabretto<sup>1,2</sup>, S. Carraro<sup>1</sup>, M. Facco<sup>1,2</sup>, T. Kawakami<sup>7</sup>, H. Nakazawa<sup>7</sup>, L. Trentin<sup>1</sup>, B. Falini<sup>6</sup>, E. Tiacci<sup>6</sup>, F. Ishida<sup>8</sup>, G. Semenzato<sup>1,2</sup>, T. Kelkka<sup>3,4</sup>, S. Mustjoki<sup>3,4,9</sup>, R. Zambello<sup>1,2</sup>

<sup>1</sup>Department of Medicine, Hematology and Clinical Immunology Branch, University of Padova, Italy; <sup>2</sup>Veneto Institute of Molecular Medicine (VIMM), Padova, Italy; <sup>3</sup>Hematology Research Unit Helsinki, University of Helsinki and Helsinki University Hospital Comprehensive Cancer Center, Helsinki, Finland; <sup>4</sup>Translational Immunology Research Program and Department of Clinical Chemistry and Hematology, University of Helsinki, Helsinki, Finland; <sup>5</sup>Department of Computer Science, Aalto University, Espoo, Finland; <sup>6</sup>Institute of Hematology and Center for Hemato-Oncology Research, University and Hospital of Perugia, Perugia, Italy; <sup>7</sup>Department of Internal Medicine, Division of Hematology, Shinshu University School of Medicine, Matsumoto, Japan; <sup>8</sup>Department of Biomedical Laboratory Sciences, Shinshu University School of Medicine, Matsumoto, Japan; <sup>9</sup>iCAN Digital Precision Cancer Medicine Flagship, Helsinki, Finland

**Introduction:** CD4+ T-cell large granular lymphocyte leukemia (T-LGLL) is a chronic lymphoproliferative disease characterized by the clonal expansion of cytotoxic T-cells. Several studies detected somatic STAT5B mutations in CD4+ T-LGLL with an incidence up to 55% but the screening was limited to small number of patients or restricted to hotspot regions. The etiology of CD4+ T-LGLL still remains elusive, even though the most likely hypothesis rests on the presence of an antigen-driven expansion triggered by an unknown event. Here, 35 CD4+ T-LGLL patients were profiled with STAT5B amplicon and T-cell receptor (TCR)  $\beta$  sequencings to better elucidate their molecular landscape.

**Methods:** The international collaboration allowed the recruitment of the largest cohort molecularly profiled. Leukemic clones were immunomagnetically purified with anti-CD4/57 beads. CD4+ T-cells from 37 healthy blood donors were used as controls. STAT5B amplicon sequencing was performed through the Illumina platform and results were analyzed with Integrative Genome Viewer (IGV). The transcriptional activity of the newly discovered variants was assessed through the transfection of HeLa cells with plasmids and a luciferase reporter. Finally, TCR $\beta$  sequencing was conducted with Adaptive Biotechnologies' ImmunoSEQ assay.

**Results:** Median age at diagnosis of the CD4+ T-LGLL patients was 72 years, without gender bias. All the clones resulted CD57+, often co-expressing a CD56+CD16- phenotype. Increased LGL and lymphocyte counts were observed in patients presenting STAT5B mutations. Within the entire cohort, 66% of cases presented at least one STAT5B mutation. Of novelty, 22% of the mutated cases presented multiple mutations that were detected in either different or same alleles. T628S variant was detected for the first time in CD4+ T-LGLL and resulted the second most frequent mutation (22%) after the N642H (39%). Functional characterization of new E433K and V712E variants confirmed to be highly activating when compared to the wild-type STAT5B construct. TCR $\beta$  sequencing identified a total number of 59 T-LGLL clones. Of note, TCR repertoires of both leukemic and non-leukemic (<5%) expansions resulted to be clonal compared to controls, suggesting the presence of a common antigenic pressure driving the disease. None of the 59 CD4+ T-LGLL clones was shared within patients. However, some clonotypes were shared with the non-leukemic cells and/or healthy cells even though at very low frequencies. The same clones were tested for the recognition of viral antigens but exact matches were not found.

**Conclusions:** Detection of STAT5B mutations in most CD4+ T-LGLL cases must be regarded as central in the diagnostic workflow since they may boost the clonal persistence as observed by the increased LGL count in STAT5B mutated patients. The shared clonotypes found between

leukemic and non-leukemic CD4+ T-cells further support the central role of antigen-driven responses in the pathogenesis of CD4+ T-LGLL.

### C26

#### FOCAL ADHESION KINASE (FAK) ACTIVATION MEDIATES BOOSTING OF WNT5A/CXCL12 CHEMOTAXIS IN CHRONIC LYMPHOCYTIC LEUKAEMIA (CLL)

N. Mouawad<sup>1</sup>, F. Frezzato<sup>1,2</sup>, A. Visentin<sup>1,2</sup>, F. Severin<sup>1,2</sup>, E. Ruggeri<sup>1</sup>, L. Martinello<sup>1</sup>, V. Trimarco<sup>1</sup>, S. Carraro<sup>1</sup>, A. Tonini<sup>1</sup>, S. Pravato<sup>1</sup>, M. Facco<sup>1,2</sup>, L. Trentin<sup>1,2</sup>

<sup>1</sup>Department of Medicine, Hematology and Clinical Immunology Branch, Padua University School of Medicine, Padua; <sup>2</sup>Veneto Institute of Molecular Medicine (VIMM), Padua, Italy

**Introduction:** WNT5a activates ROR1, a tyrosine-kinase-like transmembrane receptor, aberrantly expressed in CLL. The activation of ROR1 promotes tumour growth, activating cytoskeletal-actin polymerization through the recruitment of HS1/Cortactin, thus enhancing chemotaxis toward CXCL12. Of note, Cortactin and HS1 are two homolog proteins, both being overexpressed and strongly related to poor prognosis in CLL. Focal Adhesion Kinase (FAK) is involved in cellular migration, adhesion and metastasis. At focal adhesions, FAK recruits adaptors and signalling proteins, such as HS1 and Cortactin, which contribute to the turnover of the actin cytoskeleton, thus leading to cell migration. We then hypothesized that FAK could be necessary for boosting WNT5a/CXCL12 chemotaxis, together with HS1 and Cortactin and may affect the disease outcome in patients with poor prognosis.

**Methods:** By WB, FAK expression and its kinase activity (phosphorylation at Tyr397) were analyzed in B-cells from 10 healthy subjects and 142 CLL patients: 67 IGHV-mutated and 56 unmutated. Cortactin and HS1 expression was evaluated in 12 patients by flow cytometry (FC). Reverse phase protein array (RPPA) analysis was performed on 57 CLL patients and 11 healthy subjects to assess the expression of several proteins, including those related to the cytoskeleton. CLL-cell migration using Trans-well assay in response to CXCL12 was assessed in 5 patients by FC, without or with the addition of exogenous WNT5a and under conditions whereby active FAK is inhibited by Defactinib or not.

**Results:** CLL patients with poor prognosis, according to the IGHV gene mutation status showed a higher phosphorylation degree of FAK at Tyr397 (pFAK), index of FAK activation, by western blot analysis. In terms of RPPA data, patients were divided into pFAK-high vs pFAK-low, according to the obtained median value. A significant positive correlation was proven between HS1 and Cortactin expression levels and FAK activation (values in pFAK-low vs high, respectively: 250±65 vs 298±74; p<0.01 for HS1; 303±122 vs 366±118; p<0.05 for Cortactin). This relationship was also confirmed by FC (697±399 vs 265±137; 1618±1575 vs 232±139, p<0.05, MFI for Cortactin and HS1 respectively). Notably, we demonstrated that 1 $\mu$ M of Defactinib reduces significantly the capacity of WNT5a to enhance CXCL12-directed CLL-cell migration compared with the non-inhibited control (P<0.0001).

**Conclusions:** Our data demonstrate that IGHV-unmutated CLL patients associated with poor prognosis display higher levels of active FAK correlated with the overexpression of HS1 and Cortactin accounting for CLL aggressiveness. WNT5a-enhanced CXCL12-directed CLL-cell migration depends on the activation of FAK. Collectively, these results suggest that FAK plays an important role in ROR1-dependent WNT5a-enhanced CXCL12-directed CLL-cell migration which merits further studies.

## C27

**DISTINCT DYSREGULATED CIRCULAR RNAs DISCRIMINATE SYMPTOMATIC FROM INDOLENT T-CELL LARGE GRANULAR LYMPHOCYTE LEUKEMIAS**

C. Vicenzetto<sup>1,2</sup>, A. Buratin<sup>3,4</sup>, V.R. Gasparini<sup>1,2</sup>, A. Binatti<sup>3</sup>, A. Teramo<sup>1,2</sup>, G. Calabretto<sup>1,2</sup>, G. Barilà<sup>1,2</sup>, E. Gaffo<sup>3</sup>, A. Dal Molin<sup>3</sup>, L. Trentin<sup>1</sup>, M. Facco<sup>1,2</sup>, G. Semenzato<sup>1,2</sup>, R. Zambello<sup>1,2</sup>, S. Bortoluzzi<sup>3,5</sup>

<sup>1</sup>Department of Medicine, Hematology and Clinical Immunology Branch, University of Padova; <sup>2</sup>Veneto Institute of Molecular Medicine (VIMM); <sup>3</sup>Department of Molecular Medicine, University of Padova; <sup>4</sup>Department of Biology, University of Padova; <sup>5</sup>CRIBI

**Introduction:** T-cell Large granular lymphocytes leukemia (T-LGLL) is a rare lymphoproliferative disorder. Immunophenotype and mutational status of the LGL clone discriminate symptomatic patients [CD8+ STAT3 mutated (mut)], characterized by neutropenia and reduced survival, from indolent cases [CD8+ wild type (wt) and CD4+ STAT5B wt or mut, together referred as others (OTH)]. Since current treatments are mostly ineffective, understanding T-LGLL pathogenesis is an unmet clinical need to identify new druggable targets. STAT3 is a known pathogenic player and its activating mutations are linked to neutropenia development, as a consequence of miR-146b repression, suggesting a role of non-coding RNA in T-LGLL. This study focused on circular RNAs (circRNAs), single-stranded covalently closed RNA molecules, generated by backsplicing, whose dysregulation can drive leukemogenesis and for which no data are available in T-LGLL.

**Methods:** CircRNAs were identified and quantified by CirComPara2 in RNA-seq data of immunomagnetically purified LGL from a discovery cohort of 20 cases, representative of the T-LGLL subsets, and 5 controls (CTR). Differential expression was assessed by edgeR. Circular to linear proportion (CLP) was calculated as the proportion of circular isoforms related to its linear counterpart from the same host gene and differential CLP analysis was obtained by CircTest. RT-qPCR and Sanger sequencing were performed on purified LGL from an independent validation cohort of 20 patients and 6 CTR to confirm RNA-seq results.

**Results:** Unsupervised analysis of circRNAs expression profiles clearly separated CD8+ STAT3 mut cases from both CTR and OTH, pointing out peculiarities of the circRNAome in symptomatic patients. 500 differentially expressed (DE) circRNAs were observed in CD8+ STAT3 mut vs CTR; 358 were those DE between CD8+ STAT3 mut and OTH. CLP analysis identified many circRNAs whose dysregulation in T-LGLL is uncoupled from the variation of their linear counterpart. Some circRNAs, derived from known STAT3 target genes, were specifically upregulated in presence of STAT3 hyperactivating mutations. We also identified 507 circRNAs dysregulated only in OTH cases; circRNA-involving axes putatively characterizing asymptomatic patients are under evaluation. CircRNAs with the highest absolute expression and marked variation were selected for further study. After confirming the backsplice sequence of these circRNAs by Sanger sequencing, quantification in the validation cohort assessed the dysregulation of several circRNAs in CD8+ STAT3 mut or in OTH patients.

**Conclusions:** Our data herein reported on the differential circRNAs expression in T-LGLL suggests a link between dysregulated circRNAs and the development of clinically different T-LGLL proliferations. Computational predictions and experimental validations of circRNA functions aim to clarify how specific circRNAs are involved in T-LGLL pathogenesis and contribute to the development of a symptomatic disease.

## C28

**RITUXIMAB TREATMENT FOR IGM-RELATED, ANTI MAG-ASSOCIATED POLYNEUROPATHIES: INTERDISCIPLINARY CHARACTERIZATION AND EVALUATION OF LONG TERM RESPONSE**

I. Dogliotti<sup>1</sup>, M. Parisi<sup>2</sup>, M. Clerico<sup>3,4</sup>, D. Bertuzzo<sup>5</sup>, G. Benevolo<sup>6</sup>, L. Orsucci<sup>6</sup>, I. Schiavetti<sup>7</sup>, A. Di Liberto<sup>8</sup>, F. Cavallo<sup>3,4</sup>, S. Ragaini<sup>3,4</sup>, D. Drandi<sup>3</sup>, M. Ferrante<sup>3</sup>, M. Borriero<sup>3</sup>, D. Ferrero<sup>3,4</sup>, L. Lopiano<sup>2</sup>, B. Ferrero<sup>2</sup>, S. Ferrero<sup>3,4</sup>

<sup>1</sup>Stem Cell Transplant Unit, University Hospital A.O.U. "Città della Salute e della Scienza"; <sup>2</sup>Department of Neuroscience "Rita Levi Montalcini", University of Turin; <sup>3</sup>Division of Hematology, Department of Molecular Biotechnologies and Health Sciences, University of Turin; <sup>4</sup>Division of Hematology 1 U, A.O.U. "Città della Salute e della Scienza"; <sup>5</sup>Department of Neurology, Cardinal Massaia Hospital; <sup>6</sup>Division of Hematology, AOU "Città della Salute e della Scienza di Torino"; <sup>7</sup>Section of Biostatistics, Department of Health Sciences, University of Genoa; <sup>8</sup>Department of Neurology, San Giovanni Bosco Hospital

**Introduction:** IgM-related polyneuropathy (PNP) is an underdiagnosed condition associated to Waldenström Macroglobulinemia (WM) and IgM monoclonal gammopathy of undetermined significance (MGUS). It is a chronic, disabling PNP, characterized by anti-myelin-associated glycoprotein (anti-MAG) IgM antibodies in the serum. Previous studies with rituximab (RTX), though promising, were hampered by not well-defined diagnostic criteria and limited follow-up (FU).

**Methods:** Between 2017 and 2019 pts with monoclonal component and suspected PNP were evaluated by a multidisciplinary team. All pts underwent marrow biopsy, flow cytometry, and MYD88<sup>L265P</sup> mutational screening by ddPCR: WM or IgM MGUS pts matching diagnostic criteria for demyelinating PNP were selected. Neurological evaluation by clinical and disability scales and standardized neurophysiological study (ENG) was performed before treatment (t0), at 12 (t1) and 24 months (t2). To assess PNP severity and disability, we employed: 1) Medical Research Council (MRC) Score, for muscle strength; 2) Inflammatory Neuropathy Cause and Treatment (INCAT) and modified Inflammatory Sensory Scale (mISS) for sensory deficits; 3) Patient Global Impression of Change (PGIC) for patients' perception of symptoms improvement.

**Results:** Overall, 97 pts were evaluated: 28 were confirmed as IgM-related PNP and were included in this study; 21 were male, median age was 72. 25/28 had symptomatic PNP while 3 were still asymptomatic but showed typical progressive ENG pattern. 24/28 pts had WM, 4 MGUS; involved light chain was K in 25/28. Anti-MAG antibodies were present in 23 pts, MYD88<sup>L265P</sup> was mutated in 24/27 (89%). Median IgM level was 833 mg/dl (range 121-4325). 4 pts had been pretreated with RTX. Overall, 23 pts received 4 weekly RTX 375 mg/m<sup>2</sup>, while 5 WM pts were treated for concurrent hematologic indications, thus receiving 6x RTX, cyclophosphamide (CTX), dexamethasone (RCD). Median FU after therapy was 29.5 months (15-40). RTX had a manageable safety profile, with only 9 G2 infusion related reactions. At t2 both clinical and ENG parameters improved significantly from baseline, namely MRC (p=0.01), mISS (p=0.003) and INCAT scales (p<0.001) particularly in upper limbs. Moreover, ENG showed improved distal motor latency (DML, p=0.028), Compound Muscle Action Potential (CMAP, p=0.007) and Sensory Action Potential (SAP) amplitude (p=0.017) on the ulnar nerves (Table 1). Median IgM level after therapy was 398 (83-1152) at t1 and 376 (76-1732) at t2. 8/28 pts received subsequent treatment, 5 with additional RTX for PNP relapse. At last FU, 5 pts were in very good partial response, 9 in partial response, 10 in minimal response, 3 had stable disease and 1 progressive disease.

**Conclusions:** This study showed for the first time long-term patient-reported benefit and objective efficacy of RTX in a well-defined IgM-related PNP population. Early multidisciplinary evaluation and pre-emptive RTX treatment might improve pts outcome.

**C29**

**GENOMIC MUTATION PROFILE IN CHRONIC LYMPHOCYTIC LEUKEMIA (CLL): RESULTS FROM A REGIONAL CLINICAL RESEARCH PROJECT BASED ON TARGETED NEXT GENERATION SEQUENCING**

R. Murru<sup>1</sup>, G. Piras<sup>2</sup>, S. Uda<sup>1</sup>, M. Monne<sup>2</sup>, A. Galitzia<sup>3</sup>, P. Uva<sup>4</sup>, R. Cusano<sup>5</sup>, R. Asproni<sup>2</sup>, M. Murineddu<sup>2</sup>, F. Culurgioni<sup>1</sup>, A. Uras<sup>2</sup>, A. Bianchi<sup>2</sup>, S.A.M. Urru<sup>6</sup>, G. Loghi<sup>1</sup>, I. Tandurella<sup>1</sup>, M. Massidda<sup>4</sup>, C. Mereu<sup>2</sup>, A.D. Palmas<sup>2</sup>, E. Angelucci<sup>7</sup>, G. La Nasa<sup>1,3</sup>

<sup>1</sup>SC Ematologia e CTMO, Ospedale Oncologico A. Businco, ARNAS “G. Brotzu”; <sup>2</sup>UOC Ematologia e CTMO, Ospedale San Francesco, ATS Sardegna, ASSL Nuoro; <sup>3</sup>Dipartimento di Scienze Mediche e Sanità Pubblica, Università degli Studi di Cagliari; <sup>4</sup>Bioinformatica Clinica, IRCCS Istituto Giannina Gaslini; <sup>5</sup>CRS4, Centro di Ricerca, Sviluppo e Studi Superiori in Sardegna, Parco Tecnologico Polaris; <sup>6</sup>Unità Operativa Farmacia, Azienda Provinciale per i Servizi Sanitari di Trento; <sup>7</sup>SC Ematologia e Centro Trapianti, IRCCS Ospedale Policlinico San Martino, Italy

**Introduction:** Genetic complexity of CLL has been revealed by NGS analysis, leading to a comprehensive view of structural variants, somatic mutations and different layers of epigenetic changes. We explored the clinical impact of recurrent gene mutations in a real life CLL cohort by a multigene panel of 12 predicted or clinically proven genes associated with risk of CLL.

**Methods:** DNAs obtained from peripheral blood specimens of 162 CLL patients were used to produce libraries with the TruSeq Custom Amplicon Kit (Illumina) for the coding regions of the following genes: BIRC3, DDX3X, KLHL6, MED12, MYD88, NOTCH1, POT1, PTPN6, SAMHD1, SF3B1, TP53, XPO1. Massive parallel sequencing was performed on Illumina HiSeq3000. The average coverage depth was >1000X. Somatic mutations were called using MuTect2 according to GATK best practices. Variants were annotated with dbSNP, COSMIC, ExAC and gnomAD databases and in silico tools were used for predictions of pathogenicity. After filtering, somatic mutations were classified as pathogenic, likely pathogenic (LP) or variant of uncertain significance (VUS).

**Results:** Blood samples were collected at different stage of disease: 36% of CLL patients have already been treated with at least one line of therapy at time of sampling, 102 patients (63%) were treatment naïve. Median follow up from diagnosis of the entire cohort was 9.97 years (0.28-31.2). A total of 345 genome variants were detected. Among the 162 patients the most commonly mutated genes were TP53(27%), NOTCH1(23%), POT1(20%), SF3B1(16%), MYD88(6%), BIRC3(3%), XPO1(2%), MED12(1%), SAMHD1(1%) in accordance with literature. DDX3X, KLHL6 and PTPN6 genes were not altered. Variants classification resulted in 84 out of 345 pathogenic mutations, 125 likely pathogenic and 136 VUS. When evaluating the total number of mutated genes, 60/162 patients (37%) had 1 pathogenic mutation while 102/162 (63%) had >2 variants with one pathogenic mutation co-occurring with a VUS or LP. Gene mutation profiles and concurrent biological and clinical characteristics (age, Binet stage, Dohner-prognosticator FISH, IGHV) were also analyzed. There was a statistically significant benefit in OS in patients without pathogenic variants compared to those with gene alterations with median OS not reached vs 16.9 yrs, respectively (p<0.05). Moreover, although not statistically significant median OS was reached at 27.1 yrs for patients with at least 1 mutation while not reached for wild type patients. Patients with ≥3 mutations harbored TP53 mutation which co-occurred with POT1, SF3B1 and NOTCH1 genes mutation. No statistical difference in terms of TTF has been found.

**Conclusions:** Our proof-of-concept demonstration of targeted gene sequencing confirmed that NGS reveals the feasibility of this approach but identifies specific challenges to be dealt with in future projects. Prospective trials are needed to stratify CLL pts in order to confirm mutations clinical impact and to address the possible future use as biomarkers.

**C30**

**PRELIMINARY SAFETY AND EFFICACY DATA FROM PATIENTS (PTS) WITH RELAPSED/REFRACTORY (R/R) B-CELL MALIGNANCIES TREATED WITH THE NOVEL B-CELL LYMPHOMA 2 (BCL2) INHIBITOR BGB-11417 IN MONOTHERAPY OR IN COMBINATION WITH ZANUBRUTINIB**

P. Ghia<sup>1</sup>, C. Tam<sup>2,3,4,5</sup>, E. Verner<sup>6,7</sup>, M. Lasica<sup>4</sup>, A. Arbelaez<sup>8,9</sup>, P. Browett<sup>10</sup>, J. Soumerai<sup>11</sup>, J. Hilger<sup>12</sup>, Y. Fang<sup>12</sup>, J. Huang<sup>12</sup>, D. Simpson<sup>12</sup>, S. Opat<sup>13,14</sup>, C. Cheah<sup>15,16,17</sup>

<sup>1</sup>Università Vita-Salute San Raffaele and IRCCS Ospedale San Raffaele; <sup>2</sup>Peter MacCallum Cancer Centre; <sup>3</sup>University of Melbourne; <sup>4</sup>St Vincent’s Hospital Melbourne; <sup>5</sup>Royal Melbourne Hospital; <sup>6</sup>Concord Repatriation General Hospital; <sup>7</sup>University of Sydney; <sup>8</sup>John Flynn Private Hospital; <sup>9</sup>Pindara Private Hospital; <sup>10</sup>Department of Haematology, Auckland City Hospital; <sup>11</sup>Massachusetts General Hospital Cancer Center and Harvard Medical School; <sup>12</sup>BeiGene (Shanghai) Co., Ltd. and BeiGene USA, Inc.; <sup>13</sup>Monash Health; <sup>14</sup>Monash University; <sup>15</sup>Department of Haematology, Sir Charles Gairdner Hospital and Pathwest Laboratory Medicine; <sup>16</sup>Medical School, University of Western Australia; <sup>17</sup>Linear Clinical Research

**Introduction:** BGB-11417, a potent and highly selective BCL2 inhibitor, had superior antitumor activity vs venetoclax (approved BCL2 inhibitor) in human acute lymphoblastic leukemia, mantle cell lymphoma (MCL), and diffuse large B-cell lymphoma xenograft models. BGB-11417 had a favorable PK profile with excellent bioavailability and BCL2 selectivity at <1 nM. Toxicology studies showed a broad therapeutic index and tolerable safety profile. Zanubrutinib (zanu), a next-generation BTK inhibitor with excellent activity and favorable toxicity in pts with chronic lymphocytic leukemia/small lymphocytic lymphoma (CLL/SLL) and MCL, is approved for MCL, R/R marginal zone lymphoma, and Waldenström’s macroglobulinemia (WM). Combining BCL2+BTK inhibitors is tolerable with synergistic activity in CLL and MCL.

**Methods:** BGB-11417-101 (NCT04277637), a phase 1, open-label, multicenter, dose-escalation/expansion study, examined BGB-11417 +/- zanu in non-Hodgkin lymphoma (NHL) or CLL/SLL. For dose escalation, pts with R/R B-cell malignancies were enrolled in 1 of 5 BGB-11417 dose cohorts (40, 80, 160, 320, or 640 mg QD). All pts used a ramp-up to intended target dose that varied by disease. Pts in the combination arm received zanu 320 mg daily starting 8-12 wks before BGB-11417 introduction. Adverse events (AEs) were reported per Common Terminology Criteria for AEs v5.0. Dose-limiting toxicity (DLT) was assessed from ramp-up through day 21 at intended daily dose; Bayesian logistic regression determined the maximum tolerated dose.

**Table 1.**

<b>BGB-11417 Monotherapy (n=14)</b>		
<b>Adverse Events (≥2 pts), n (%)</b>	<b>All Grade</b>	<b>Grade ≥3</b>
Nausea	7 (50)	0
AST increased	3 (21.4)	1 (7.1)
Constipation	3 (21.4)	0
Diarrhea	3 (21.4)	0
Dizziness	3 (21.4)	0
Neutrophil count decreased + neutropenia	3 (21.4)	3 (21.4)
ALT increased	2 (14.3)	1
Anemia	2 (14.3)	0
Dyspnea	2 (14.3)	0
Hypokalemia	2 (14.3)	1 (7.1)
Musculoskeletal chest pain	2 (14.3)	0
Peripheral edema	2 (14.3)	0
Pyrexia	2 (14.3)	1 (7.1)
Vomiting	2 (14.3)	0
<b>BGB-11417 + Zanubrutinib (n=5)</b>		
<b>Adverse Events (≥1 pt), n (%)</b>	<b>All Grade</b>	<b>Grade ≥3</b>
Back pain	1 (20)	0
Cellulitis	1 (20)	0
Constipation	1 (20)	0
GGT increased	1 (20)	0
Headache	1 (20)	0
Nausea	1 (20)	0
Petechiae	1 (20)	0
Rash maculo-papular	1 (20)	0
Vision blurred	1 (20)	0

Abbreviations: ALT, alanine aminotransferase; AST, aspartate aminotransferase; GGT, gamma-glutamyl transferase.

**Results:** As of 24 May 2021 (data cutoff) 19 pts were treated; 14 with monotherapy (NHL: n=11; CLL/SLL: n=3) and 5 with combination (all CLL; 3 on zanu pretreatment; 2 started combination). All pts (median age, 72 y) were R/R (median of 2 prior regimens); median follow-up

was 1.9 mo. No DLTs were seen in pts with NHL receiving BGB-11417 alone (n=11) up to 160 mg. Reported AEs across all doses are shown in Table 1. Five pts (all NHL) discontinued treatment (disease progression, n=4 [2 at 40 mg, 2 at 80 mg]; lack of efficacy, n=1 [40 mg]). No pt discontinued due to AEs. Laboratory tumor lysis syndrome was observed in 1 pt with CLL and high tumor burden (resolved with no sequelae). Initial efficacy after 3-mo restaging in pts with CLL/SLL had 1 one partial response (monotherapy) at the first dose level tested. All pts with CLL/SLL completing ramp-up (n=2, both monotherapy) normalized absolute lymphocyte count (ALC). Marked decreases in ALC occurred at doses as low as 1 mg (Figure 1).

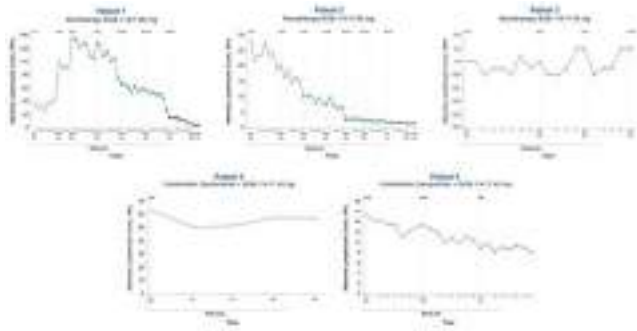

Figure 1. Absolute lymphocyte count in pts with CLL.

**Conclusions:** Preliminary results suggest BGB-11417 is tolerable in R/R NHL at the tested dose levels. Updated safety and efficacy data of BGB-11417+/-zanu in CLL/SLL and NHL will be presented; evaluation of treatment-naïve CLL/SLL, R/R MCL, and R/R WM is planned.

This study was sponsored by BeiGene, Ltd. Writing and editorial assistance was provided by Elizabeth Hermans, PhD (Peloton Advantage, LLC, an OPEN Health company, Parsippany, NJ), and funded by the study sponsor.

**C31**

**B-CELL RECEPTOR SIGNALING PROFILES IDENTIFY SUBSETS OF MANTLE CELL LYMPHOMA PATIENTS WITH DIFFERENT CLINICAL OUTCOMES**

F.M. Quaglia<sup>1</sup>, S. Gambino<sup>2</sup>, C. Cavallini<sup>3</sup>, B. Rufini<sup>2</sup>, O. Lovato<sup>3</sup>, M. Krampera<sup>1</sup>, C. Visco<sup>1</sup>, M.T. Scupoli<sup>2,3</sup>

<sup>1</sup>Department of Medicine, Section of Hematology, University of Verona; <sup>2</sup>Department of Neurosciences, Biomedicine and Movement Sciences, University of Verona; <sup>3</sup>Research Center LURM, Interdepartmental Laboratory of Medical Research, University of Verona, Italy

**Introduction:** B cell receptor (BCR) signaling is a driving event in the development and progression of Mantle Cell Lymphoma (MCL). Recent evidence supports that BCR signaling is involved in drug resistance mechanisms and is a target for therapy. As clinical features and responses vary across patients, the aim of our research is to explore the variability of BCR signaling in MCL and unveil possible relationship with clinical outcome.

**Methods:** We measured the phosphorylation status of nine BCR signaling phosphoproteins, namely pSYK, pLCK, pBTK, pPLCγ2, pp38, pERK1/2, pAKT, pNF-κB p65, pSTAT5, at the single cell level using phospho-specific flow cytometry combined with fluorescent cell barcoding (FCB) in peripheral blood mononuclear cells (PBMCs) from 10 MCL patients collected at diagnosis. The phosphorylation status of signaling proteins was measured in the basal condition and following BCR stimulation with anti-IgG, anti-IgD, anti-IgM antibodies, or their combination. Fluorescence intensity values were expressed as inverse hyperbolic sine (arcsinh) and corrected for the autofluorescence signals. Responses to BCR stimulation were calculated relative to signals in the basal condition. Then, arcsinh transformed data were subjected to unsupervised hierarchical cluster analysis (HCA) within the MCL samples. Association between signaling-defined groups of patients and clinical

parameters was performed using Fisher's exact test.

**Results:** Analysis of signaling phosphoproteins in the basal condition revealed high levels of pBTK, pPLCγ2, and pSTAT5, with no or very low basal levels of pSYK, pLCK, pAKT and pNF-κB p65. After BCR stimulation with anti-IgM, we showed an overall significant higher level of both BCR proximal (pSYK, pLCK, pBTK, pPLCγ2) and more distal (pp38, pERK1/2, pAKT) signaling nodes compared to unstimulated, excepted for pNF-κB p65 and pSTAT5. In contrast, anti-IgG or anti-IgD stimulation did not induce phosphoproteins activation, except for pAKT, which was significantly activated after anti-IgG stimulation. Unsupervised HCA identified two main clusters of MCL patients: cluster 1 comprised samples with a lower signaling response, whereas cluster 2 included samples showing a higher signaling response. Remarkably, the BCR signaling-based clustering was significantly associated with clinical parameters including age, response to therapy, and progression of disease (POD) (Figure 1).

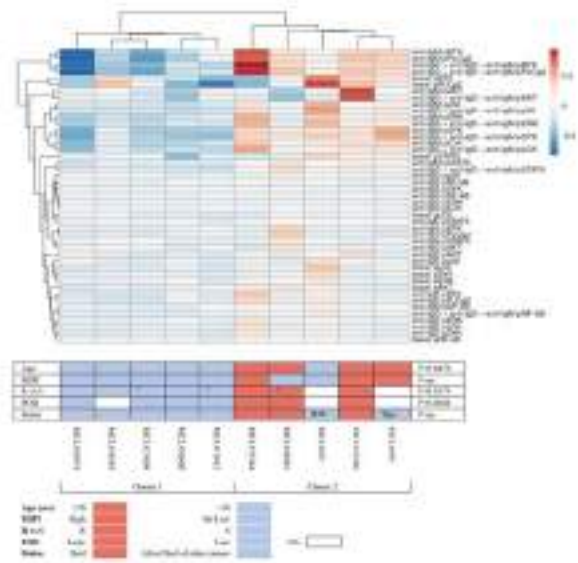

Figure 1. Hierarchical cluster analysis of BCR phosphoprotein activation within MCL samples. Phosphorylation levels are represented by pseudocolor corresponding to the relative arcsinh values. Basal levels are calculated relative to fluorescence minus one (FMO); response to stimulation is calculated relative to basal condition. Each column represents a MCL patient (n=10); each row represents a single phosphoprotein in the basal or stimulated condition. The clustering trees on top and left side of the heatmap refer to patients' samples and BCR nodes, respectively. Standard clinical parameters of each patient are aligned below the heat map. Association with clinical parameters were calculated with Fisher's exact test. Int: Intermediate; MIPI: Mantle cell lymphoma International Prognostic Index; ns: not significant; POD: progression of disease (early: within 24 months of diagnosis; late: after 24 months of diagnosis); R: refractory to first line therapy; S: sensitive to first line therapy; Status: status at the last follow up (Died: died of progressive disease versus Alive/Died of other causes); Ther: Therapy ongoing; WW: watch&wait approach; yrs: years; \*Ibrutinib treatedpatients.

**Conclusions:** Our results suggest that individual differences in BCR-signaling profiles can reflect clinical outcomes and responses to therapy, including BCR-signaling inhibitors, thus highlighting the predictive significance of BCR-signaling profiles in MCL. We thank Fondazione Italiana Linfomi (PGR Ed. 2019) and Centro Piattaforme Tecnologiche (CPT) of Verona University for technical support.

## C32

### LncRNA MAAT PROMOTES CELL SURVIVAL AND PROLIFERATION OF NEOPLASTIC T-CELLS THROUGH THE TRANSCRIPTIONAL REGULATION OF MITOPHAGY-RELATED GENE SIGNATURE

A. Tameni<sup>1</sup>, V. Mularoni<sup>1</sup>, F. Reggiani<sup>1</sup>, E. Sauta<sup>2</sup>, E. Vitale<sup>1</sup>, F. Torricelli<sup>1</sup>, I. Capodanno<sup>3</sup>, G. Inghirami<sup>4</sup>, A. Ciarrocchi<sup>1</sup>, V. Fragliasso<sup>1</sup>

<sup>1</sup>Laboratory of Translational Research, Azienda-USL IRCCS di Reggio Emilia; <sup>2</sup>IRCCS-Humanitas Research Hospital; <sup>3</sup>Division of Hematology, Azienda-USL IRCCS di Reggio Emilia; <sup>4</sup>Department of Pathology and Laboratory Medicine, Weill Cornell Medicine

**Introduction:** Advances in massive transcriptomic analyses have highlighted the characterization of the non-coding genome universe, including long non-coding RNAs (lncRNAs). Their expression is often aberrant in cancers with implication in the pathogenesis, heterogeneity and therapy responses of tumors. Coherently, our studies have demonstrated that, the most aggressive and heterogeneous subtype of Anaplastic Large Cell Lymphomas (ALCL), known as ALK<sup>+</sup>ALCL is characterized by the expression of a unique set of 18 lncRNAs compared to normal T-lymphocytes. Among these, BlackMamba is necessary to sustain the progression of ALK<sup>+</sup>ALCL by regulating a complex transcriptional program in neoplastic T-cells promoting their survival. To deeply study the role of other unique lncRNAs in ALK<sup>+</sup>ALCL, we investigated their expression and function.

**Methods:** 22 ALCLs, 4 PTCL-NOS, 10 AITL and 5 T-ALL patients were included in this study. lncRNAs expression were studied by RT-PCR. lncRNA role was assessed by luciferase, RNA-seq, ChIP assay. lncRNA silencing was performed by CRISPR-dCas9-KRAB approach.

**Results:** After a cross-validation in an independent cohort of T-lymphoma patients and cell lines, we selected XLOC\_211989 as one of the highly and selectively ALK<sup>+</sup>ALCL associated lncRNA and we named it MAAT (Mitophagy and ALK<sup>+</sup> anaplastic Lymphoma Associated Transcript). Functional experiments demonstrated that MAAT is a RNAPII transcript, with promoter-like features and nuclear/chromatin localization, suggesting a role in epigenetic regulation. To test this hypothesis, we performed RNA-seq on ALK<sup>+</sup> cells depleted for MAAT(MAAT<sup>KD</sup>). Data analysis showed that MAAT<sup>KD</sup> affects the expression of 1.497 genes (973 upregulated and 524 downregulated). Gene ontology analysis revealed the enrichments in mitochondria-related pathways and mitochondria organization, suggesting a role of MAAT in regulating these processes. RNA-seq validation showed that MAAT<sup>KD</sup> led to a significant upregulation of mitophagy genes like BNIP3, BNIP3L, MAP1LC3B. To investigate MAAT transcriptional function, we performed ChIP experiments in MAAT<sup>KD</sup> ALK<sup>+</sup> cells for active transcription markers (H3K4me3, H3K27Ac, RNAPII) and we observed a selective accumulation of these markers at the promoter regions of BNIP3/BNIP3L suggesting a transcriptional role of MAAT in mitophagy. Next, we demonstrated that MAAT<sup>KD</sup> led to reduced ALK<sup>+</sup> cell proliferation and to an increased autophagic flux. We performed mitochondrial staining proving that MAAT loss led to a strong decrease in mitochondria number and depolarization of mitochondria membranes with a reduction in mtDNA quantity. Moreover, immunofluorescences revealed that in absence of MAAT, BNIP3 colocalized with LC3 indicating an active BNIP3-dependent mitophagy process.

**Conclusions:** Collectively our data indicate that MAAT expression contributes to the ALK<sup>+</sup> cell survival by negatively and transcriptionally regulating the expression of mitophagy-related genes.

## Next Generation Diagnostics and Non-neoplastic Hematology

## C33

### CLINICAL RELEVANCE OF AN OBJECTIVE - LIMIT OF DETECTION, LIMIT OF QUANTIFICATION - BASED FLOW CYTOMETRY APPROACH FOR MEASURABLE RESIDUAL DISEASE ASSESSMENT IN ACUTE MYELOID LEUKEMIA. A POST-HOC ANALYSIS OF THE GIMEMA AML1310 TRIAL

R. Palmieri<sup>1</sup>, A. Piciocchi<sup>2</sup>, V. Arena<sup>2</sup>, L. Maurillo<sup>1</sup>, M.I. Del Principe<sup>1</sup>, G. Paterno<sup>1</sup>, M.A. Irno Consalvo<sup>1</sup>, T. Ottone<sup>1</sup>, M. Divona<sup>1</sup>, C. Conti<sup>1</sup>, D. Fraboni<sup>1</sup>, S. Lavorgna<sup>1</sup>, W. Arcese<sup>1,3</sup>, M.T. Voso<sup>1</sup>, A. Venditti<sup>1</sup>, F. Buccisano<sup>1</sup>

<sup>1</sup>Ematologia, Dipartimento di Biomedicina e Prevenzione, Università di Roma "Tor Vergata"; <sup>2</sup>Centro Dati Fondazione GIMEMA; <sup>3</sup>Rome Transplant Network

**Introduction:** Using a multiparametric flow cytometry (MFC) assay, we assessed the predictive power of a threshold calculated applying the criteria of limit of detection (LOD) and limit of quantitation (LOQ) in adult patients (pts) with Acute Myeloid Leukemia (AML). This approach for MRD determination relies on the application of absolute thresholds for the definition of MRD status. In this post-hoc analysis of in the GIMEMA AML1310 prospective trial, we compared the reliability of relative threshold of 0.035% events to the absolute LOD/LOQ approach in a cohort of 261 pts.

**Methods:** According to the protocol design, using the MRD threshold of 0.035% bone marrow residual leukemic cell (RLC) calculated on mononuclear cells, we identified two groups: MRD negative (MRD<0.035%) and MRD positive (MRD≥0.035%). Using 20 events to define LOD and 50 to define LOQ, we selected the following categories: LODneg if RLC below LOD, LODpos/LOQneg if RLC between LOD and LOQ, and LOQpos if RLC above LOQ.

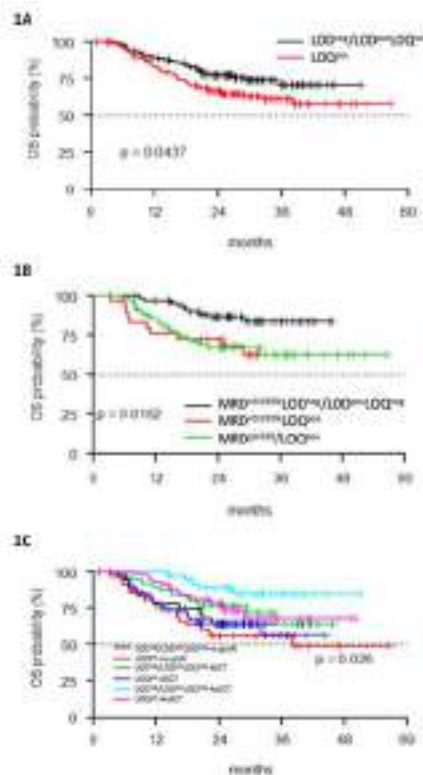

Figure 1. Overall survival of the whole series of patients: according to the LOD/LOQ status(A); when comparing the two MRD estimates (B); when comparing the three possible post-consolidation strategies (AlloSCT, AuSCT, no graft) across the LOD/LOQ categories.

**Results:** Among 261 pts, 154 (59%) were MRD<0.035% and 107 (41%) were MRD≥0.035%, while 74 (28.4%) were LODneg, 43 (16.5%) were LODposLOQneg, and 144 (54.4%) were LOQpos. Two-year overall survival (OS) of these 3 categories was 75.4% vs. 79.8% vs. 66.4%, respectively (p=0.1197). Due to superimposable outcome, we merged LODneg and LODposLOQneg groups. Two-year OS of LODneg/LODposLOQneg pts was 77.0% versus 66.4% of LOQpos ones (P=0.043) [Figure 1A]. As a second step, we integrated the two models of evaluation, MRD < or > 0.035% and LOD-LOQ approach. Pts who were [MRD<0.035%LODneg/LODposLOQneg] had a longer 2-year OS than those [MRD<0.035%LOQpos] and [MRD≥0.035%LOQpos] groups. This comparison achieved the best statistical significance when the analysis focused on pts in whom at least 500'000 CD45+ events were acquired: those [MRD<0.035%LODneg/LODposLOQneg] had a longer OS than individuals who were [MRD<0.035%LOQpos] and [MRD≥0.035%LOQpos] (86.7%, 67.0%, and 72.5% respectively, p=0.018) [Figure 1B]. Further, MRD<0.035% pts had a statistically different OS based on the belonging to LODneg/LODposLOQneg or LOQpos category (86.7% vs 72.5%, p=0.007). Finally, we explored the interaction between the LOD-LOQ groups and the post-remission treatment received (AuSCT, ASCT and no graft). LODneg/LODposLOQneg pts submitted to AuSCT had the best 2-year OS (88.9%) than the other categories (p=0.026). Indeed, these pts benefitted the most from AuSCT (88.9%) than from no-graft (55.9%, p=0.017) or ASCT (76.5%, p=0.089) [Figure 1C]. The independent role of LOD-LOQ approach in influencing OS was confirmed in multivariate analysis (p=0.048, HR 0.628, 95% CI 0.396-0.997).

**Conclusions:** the use of LOD-LOQ method results in a more sensitive detection of MRD especially when and adequate number (≥500'000) of events is acquired. Such a refinement of MRD determination translates in a more accurate recognition of subjects with different outcome, possibly improving the process of transplant allocation.

### C34

#### SULFUR EXAFLUORIDE CONTRAST-ENHANCED ULTRASOUND SHOWING EARLY WASH-OUT OF MARKED DEGREE IDENTIFIES LYMPHOMA INVASION OF SPLEEN WITH EXCELLENT DIAGNOSTIC ACCURACY: A MONOCENTRIC STUDY OF 260 SPLENIC NODULES

C. Giordano<sup>1</sup>, M. Picardi<sup>1</sup>, N. Pugliese<sup>1</sup>, F. Trastulli<sup>1</sup>, A. Leone<sup>1</sup>, R. Della Pepa<sup>1</sup>, R. Iula<sup>1</sup>, G. Delle Cave<sup>1</sup>, M.G. Rascato<sup>1</sup>, M. Esposito<sup>1</sup>, C. Fatigati<sup>1</sup>, E. Vigliar<sup>2</sup>, G. Troncone<sup>2</sup>, M. Mascolo<sup>3</sup>, D. Russo<sup>3</sup>, M. Persico<sup>4</sup>, F. Pane<sup>1</sup>

<sup>1</sup>Department of Clinical Medicine and Surgery, Federico II University Medical School, Naples; <sup>2</sup>Department of Advanced Biomedical Sciences, Federico II University Medical School, Naples, Naples; <sup>3</sup>Department of Public Health, Federico II University Medical School Naples, Naples; <sup>4</sup>Departement of General Surgery, Endocrinology, Orthopaedics, and Rehabilitations, Federico II University Medical School Naples, Naples, Italy

Contrast enhanced ultrasonography (CEUS) use for detecting lymphoma in the spleen has been questioned because of the risk of its inadequate diagnostic accuracy. The aim of the present study was to validate CEUS for this purpose. A total of 260 spleen nodules of 77 patients with lymph node biopsy-proven non-Hodgkin lymphoma (NHL; n= 44) or Hodgkin lymphoma (HL; n= 33) at staging (n= 56) or follow-up (n= 21) were collected in the Hematology Unit of the Federico II University of Naples (Italy) and retrospectively analyzed. NHL and HL at CEUS were defined as nodules ≥0.5 cm (long axis) with hypoenhancement in the parenchymal phase, depicted as a progressive increase of nodule-to-parenchyma contrast gradient (*i.e.*, a clear hypoechoic defect of the lesion, appearing almost punched out or echo free) while moving from the arterial phase to the late phase of parenchymal opacification and early (onset <60 sec after contrast agent injection) wash-out of marked degree (≤120 sec after contrast agent injection). Diagnostic reference standard was clinical-laboratory-imaging monitoring for 230 nodules, and/or histology for 30 nodules [overall, median nodule size of 1.5 cm (0.5-7 cm)]. According to the reference standard, 204 (78%) nodules were lymphomas (aggressive-NHL [a-NHL], 122; classic-HL [c-HL],

65; indolent [i]-NHL, 17) and 56 were benign (inflammation, infection and/or mesenchymal) lesions. Sensitivity, specificity, positive predictive value, negative predictive value and overall diagnostic accuracy of CEUS for detecting lymphoma in the spleen were 95%, 100%, 100%, 85% and 96%, respectively. In a post-hoc assessment, we analyzed the microvessel density (MVD) by immunohistochemical and morphometric evaluations of vascular endothelial growth factor-A, VEGF receptor and cyclooxygenase 2 expression in 15 splenic nodules (B cell lymphomas according to H&E morphology and immunohistochemistry) of a-NHL (DLBCL, 7 lesions), c-HL (5 lesions) and i-NHL (3 lesions) for which formalin-fixed, paraffin-embedded samples were available from the archive of our Institute of Pathology. Overall, the grade of MVD was higher for both a-NHL and c-HL nodules, it decreased in the nodules in the following order: mean microvessel count of 30/0.5 mm<sup>2</sup> for a-NHL, 26/0.5 mm<sup>2</sup> for c-HL, and 20/0.5 mm<sup>2</sup> for i-NHL. Abundant angiogenesis such as vessel proliferation (endothelial cell migration and proliferation) and abnormal vascularization (tube formation with stenosis, occlusion, and/or dilation and/or arteriovenous shunts) is recognized as being critical for pathogenesis. The parenchymal phase of the perfusional study is fundamental in distinguishing the spleen involvement by lymphoma: splenic nodules appear as clear circumscribed defects of enhancement due to rapid wash-out of microbubbles as compared with the homogeneously enhanced normal parenchyma probably due to the neoangiogenic vascular structure of lymphomatous lesions (abnormal endothelial layer with large fenestration and arteriovenous shunts). We speculated that angiogenesis played a differential role in the various sub-types of lymphomas of spleen: aggressive lymphoma expresses the more marked wash-out, having the highest neoplastic microvessel density

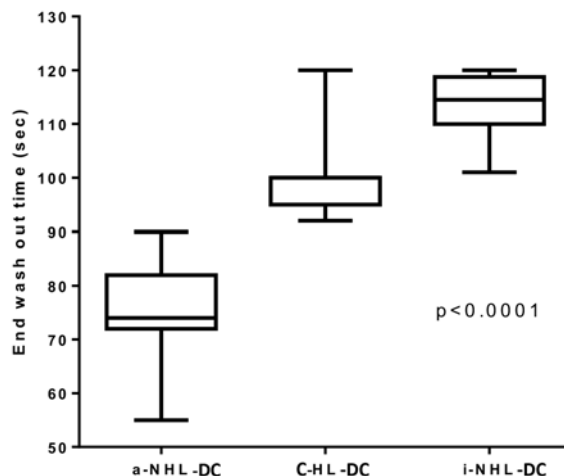

**Figure 1.** The degree of the contrast intensity of the washout of nodules in the three clinical categories of lymphomas. a-NHL-DC, aggressive-non-Hodgkin lymphoma diagnostic criteria (122 nodules); c-HL-DC, classic-Hodgkin lymphoma diagnostic criteria (60 nodules); i-NHL-DC, indolent-non-Hodgkin lymphoma diagnostic criteria (12 nodules). Marked wash-out range of 55-90 sec (median, 74 sec), 92-120 sec (median, 100 sec), and 101-120 sec (median, 111.5 sec) was 100%, 96.6% and 77% predictive of a-NHL, c-HL and i-NHL splenic nodular infiltration, respectively.

### C35

#### A NEW DIGITAL PCR METHOD FOR MEASURING THE EXPRESSION VALUES OF POLYCOMB GENES IN DLBCL

S. Galimberti<sup>1</sup>, F. Guerrini<sup>1</sup>, G. Volpe<sup>1</sup>, S. Grassi<sup>1</sup>, E. Ciabatti<sup>2</sup>, E. Forti<sup>3</sup>, R. Papotti<sup>3</sup>, S. Bettelli<sup>3</sup>, S. Sacchi<sup>3</sup>

<sup>1</sup>Dipartimento di medicina clinica e sperimentale, università di Pisa; <sup>2</sup>Medicina trasfusione, AOUP; <sup>3</sup>Azienda Ospedaliero Universitaria di Modena, Italy

**Introduction:** On the basis of cell of origin (COO) it is possible to distinguish three types of DLBCL: the "ABC", the "GCB" and the "unclassifiable". Epigenetics is involved in control of several tumors, and in particular polycomb genes (PcGs) play a key role in supporting



proliferation in acute and chronic myeloid leukemias. In the lymphoma setting, one third of patients with follicular lymphoma present EZH2 mutations; in DLBCL, EZH2 mutations are more frequent in the GCB form, but few data are available concerning other PcGs; in this study we measured the expression of some PcGs, such as BMI1, EZH2 and USP22, and matched these data with COO and clinical outcome of 56 DLBCL patients.

**Methods:** COO had been well identified by Nanostring, as previously reported [Bettelli S, Leuk Res 2021]; expression levels of BMI1, EZH2 and USP22 was measured by Digital Droplet PCR, a sensitive and specific technique allowing an absolute quantification without use of external references. GAPDH was adopted as internal reference gene and a multiplexing analysis has been performed. This technique allows to detect different targets by using several probes conjugated with the same fluorophore (FAM or HEX) but at different concentrations, quantifying three or more targets in a single reaction. If targets A and B have 50% and 100% FAM-probes concentrations respectively and C and D have 50% and 100% of HEX-probes concentrations, in the 2D dispersion plot 16 possible clusters are generated: those containing only one gene (A, B, C and D), those with simultaneously two genes (AB, CD, AC, BC, AD and BD) and clusters expressing 3 genes.

**Results:** We simultaneously tested expression of 3 PcGs in 56 DLBCL patients already biologically and clinically well characterized. The expression levels of the three genes were extremely variable: BMI1/GAPDH 0.20-20; EZH2/GAPDH 0.26-31.5; USP22/GAPDH 0.86-19.5, with median expression values of 4.37, 2.29 and 4.4, respectively. The expression of the three genes appeared to be correlated: patients with low expression levels of BMI1 also showed low EZH2 and USP22 expression levels. We didn't find any significant correlation between the expression levels of the three genes and age, sex, COO, and response to the treatment (R-CHOP). Nevertheless, BMI1 and EZH2 higher expression played a negative impact on median 3-y OS (90% for subjects with low BMI1 vs 50% of those with high BMI1 ( $p=0.02$ ) and 90% for subjects with low EZH2 vs 55% of those with higher expression;  $p=0.04$ ).

**Conclusions:** In this study for the first time we present a new sensitive and accurate dd-PCR method that allows to test and quantify the expression of multiple PcGs at the same time, very useful in case of samples with scarce availability, as in case of paraffin-embedded ones. Moreover, the negative prognostic role of BMI1, that resulted well correlated with EZH2 and independent from COO, might open the way to a possible target therapy by both inhibitors, also in GCB forms.

## C36

### COMPARISON BETWEEN METHODS TO CHECK THE QUALITY OF BONE MARROW ASPIRATE SAMPLES FOR THE MINIMAL RESIDUAL DISEASE EVALUATION IN MULTIPLE MYELOMA AND ACUTE LYMPHOBLASTIC LEUKEMIA

I. Vigliotta<sup>1</sup>, S. Armuzzi<sup>1,2</sup>, M. Barone<sup>1,2</sup>, V. Solli<sup>1,2</sup>, I. Pistis<sup>1,2</sup>, E. Borsi<sup>1</sup>, M. Martello<sup>1</sup>, A. Poletti<sup>1,2</sup>, B. Taurisano<sup>1,2</sup>, G. Mazzocchetti<sup>1,2</sup>, E. Zamagni<sup>1,2</sup>, I. Rizzello<sup>1,2</sup>, L. Pantani<sup>1,2</sup>, S. Rocchi<sup>1,2</sup>, P. Tacchetti<sup>1,2</sup>, K. Mancuso<sup>1,2</sup>, M. Arpinati<sup>1,2</sup>, M. Cavo<sup>1,2</sup>, C. Terragna<sup>1</sup>

<sup>1</sup>IRCCS Azienda Ospedaliero-Universitaria di Bologna – Istituto di Ematologia “Seràgnoli”; <sup>2</sup>DIMES – Dipartimento di Medicina Specialistica, Diagnostica e Sperimentale, Università di Bologna - Istituto di Ematologia “Seràgnoli”, Italy

**Introduction:** Minimal residual disease (MRD) provides critical information for the management of the hematological patients (pts), allowing the modulation of therapeutic intensity, aimed at obtaining the eradication of residual disease. The disease dynamics are commonly measured within the bone marrow (BM) aspirate, highly representative of the disease distribution in most hematological diseases, e.g. Multiple Myeloma (MM) and Acute Lymphoblastic Leukemia (ALL). However, the quality of samples might be one of the main pitfalls of the method, since the dilution of the tumor cells in the peripheral blood (hemodilution, HD), can impair the MRD measurement, causing the underestimation of residual cells and possible false negative results. To date, any consensus

has been established neither on criteria for samples' quality acceptability, nor on the set up of standardized protocols for HD assessment. Aim of this study has been to define a robust and reproducible method for the assessment of BM HD, supporting the quality of MRD measurements.

**Methods:** Several flow cytometry strategies for HD evaluation have been compared, in order to define the most functional in terms of reproducibility, easy-to-use management and fast response. For each BM sample, cells populations with a well-known distribution in BM and peripheral blood - i.e., plasma cells, mast cells (MC), lymphocyte precursors, erythroblasts (NRBC), immature (IG) and mature granulocytes (N) – have been studied by flow cytometry (FC) and quantified alongside the BM differential blood count. Pearson and Krustal-Wallis tests were employed to evaluate correlations.

**Results:** HD protocols validation was performed on samples from 90 MM and 19 ALL pts (126 and 44 samples, respectively), whose MRD has been measured either by Next Generation Sequencing (NGS) or by FC (ALL), in the context of the daily clinical practice. According to Pont et al. (Cytometry Part B, 2018) a cut-off IG/N ratio of 1.2 was employed, in order to stratify pts in three groups: 33/138 (24%), 36/138 (26%) and 69/138 (50%) samples, with <0.5 (HD), between 0.5 and 1.2 (mildly-HD, mHD) and over 1.2 (non-HD) IG/N ratios, respectively. The frequencies of other cells' populations were correlated to the IG/N ratio, thus highlighting a mild correlation with MCs and NRBCs ( $R=0.3$ ,  $p=0.004$ ), whereas no correlations were found with B or T-cells precursors. Overall, MRD measurements were negative in 23 samples out of 52 HD or mHD cases (44%), whereas were positive in 29 (56%).

**Conclusions:** The mild correlation between IG/N, NRBCs and MCs suggested the combined employment of these parameters to evaluate BM HD, whereas nor lymphocytes precursors or hematogones seemed informative enough to this purpose. The high frequency of MRD-negative results in both HD and mHD samples suggested possible underestimated MRD measurements, impairing the correct assessment of patients' response to therapy and highlighted the importance to evaluate BM hemodilution.

## C37

### NEW INSIGHTS INTO PATHOGENIC MECHANISM OF HEPATIC IRON METABOLISM DUE TO PIEZO1 GAIN OF FUNCTION VARIANTS

B.E. Rosato<sup>1,2</sup>, R. Marra<sup>1,2</sup>, V. D'Onofrio<sup>1,2</sup>, V.A. Lasorsa<sup>1,2</sup>, M. Capasso<sup>1,2</sup>, R. Russo<sup>1,2</sup>, A. Iolascon<sup>1,2</sup>, I. Andolfo<sup>1,2</sup>

<sup>1</sup>Department of Molecular Medicine and Medical Biotechnologies, “Federico II” University of Naples; <sup>2</sup>CEINGE, Biotechnologie Avanzate, Italy

**Background:** Dehydrated hereditary stomatocytosis (DHS) is a pleiotropic syndrome characterized by hemolytic anemia and perinatal edema. DHS is caused by gain-of-function (GoF) variants in the *PIEZO1* gene, encoding for a ubiquitous mechanoreceptor. The worst phenotypic implication is the strong tendency to iron overload. Recently, the study of the *PIEZO1* knock-in (KI) mouse model confirmed the development of severe iron overload. We demonstrated that, at hepatic level, *PIEZO1* suppresses hepcidin (key regulator of hepatic iron metabolism) expression by altering phosphorylation of the SMAD1/5/8 proteins.

**Aim:** The aim of this study is to explore the signaling pathways that links *PIEZO1* variants to hepcidin suppression.

**Methods:** Creation of engineered *PIEZO1*-KI cells by CRISPR/Cas9; calcium and potassium channel assay; differential proteomics and RNA-Seq.

**Results:** We engineered Hep3b cell model for a *PIEZO1* heterozygous variant, R2456H, by CRISPR/Cas9. *PIEZO1*-KI cells showed no alteration of *PIEZO1* expression but increased intracellular calcium content and hyperactivation of potassium channels activity compared to WT and besides, a reduced activation of the BMP/SMADs pathway with reduced HAMP expression. To further dissect the alteration of the transcriptome and proteome in *PIEZO1*-KI model, we performed differential proteomics and RNA-Seq. Differential proteomics identified 225 total proteins differentially regulated in *PIEZO1*-KI cells compared to WT ones (Protein with Log2 Difference  $\geq \pm 1$  and -Log p-value  $> 1.3$  were

considered significant). RNA-Seq identified 5689 genes differentially regulated in PIEZO1-KI cells compared to WT ones ( $p < 0.05$ , post-hoc correction by FDR). This multiomics approach revealed alterations in several genes and proteins belonging to MAPK, RAS and TGF- $\beta$  pathways, confirming previous data, but also alteration in mTOR signaling pathway.

**Conclusions:** We here dissected the mechanism by which *PIEZO1* GoF variants cause hepatic iron overload in DHS. Proteomic and transcriptomic analysis of the hepatic PIEZO1-R2456H engineered cell line revealed new actors in the regulation of the complex landscape of iron metabolism. This finding defines the mechanoreceptor as a new iron metabolism regulator and as a possible therapeutic target of iron overload.

### C38

#### NAVIGATING THROMBOPOIESIS AND ERYTHROPOIESIS IN PATIENTS WITH SEVERE COVID-19: HUMAN MEGAKARYOCYTES AND ERYTHROID PROGENITORS ARE INFECTED BY SARS-COV-2

A.G. Solimando<sup>1,2</sup>, B. Fattizzo<sup>3,4</sup>, A. Melaccio<sup>1</sup>, G. Ingravalle<sup>5</sup>, G. Cazzato<sup>5</sup>, S. Cicco<sup>1</sup>, N. Susca<sup>1</sup>, F. Pappagallo<sup>1</sup>, G. De Fazio<sup>1</sup>, A. Cizulli<sup>1</sup>, G. Lauletta<sup>1</sup>, A. Vacca<sup>1</sup>, R. Ria<sup>1</sup>

<sup>1</sup>Guido Baccelli Unit of Internal Medicine, Department of Biomedical Sciences and Human Oncology, School of Medicine, Aldo Moro University of Bari; <sup>2</sup>Medical Oncology Unit, IRCCS Istituto Tumori "Giovanni Paolo II" of Bari; <sup>3</sup>Fondazione IRCCS Ca' Granda Ospedale Maggiore Policlinico, Milan; <sup>4</sup>Department of Oncology and Oncohematology, University of Milan, Milan; <sup>5</sup>Section of Pathology, Department of Emergency and Organ Transplantation (DETO), University of Bari, "Aldo Moro", Bari, Italy

Gravity and mortality in SARS-CoV-2 infected subjects is associated with an aberrant decrease of thrombocytes, red cells, blood cell count abnormalities and with an enhanced number of erythroid precursors in the circulation. Moreover, hypoxia and coagulopathy imbalance are present. It has been suggested that COVID-19 also involves the bone marrow (BM), while exhibiting a blood cells tropism. Our aim was to investigate the interaction between the virus and the BM precursors, namely megakaryocytes and erythroid progenitors amid the COVID-19 disease, to elucidate a potential role in disrupting the physiological thrombopoiesis and erythropoiesis. An extensive in silico interrogation of publicly available datasets prompt us to import RNAseq data and analysis of ACE2, CD13 and TMPRSS2 and expression from GSE144024, GSE118537 and The Human Cell Atlas BM Single-Cell Interactive Web Portal. A sample of 20 consecutive cytopenic patients (10 pts during infection and 10 pts after about ten days from swab negativization) who were being treated for SARS-CoV-2 severe infections was analyzed. Five subjects with benign anemia were used as controls. BM trephine biopsies from patients with thrombocytopenia, anemia or bilinear cytopenia were obtained and the sections were incubated with SARS-CoV-2 spike protein S1 antibody (MA5-36247) in immunohistochemistry, rabbit monoclonal, isotype: IgG, at a concentration of 0.2  $\mu\text{g}/\text{mL}$ , with a heat-mediated antigen revelation with citrate buffer at pH 6. All subjects treated for severe SARS-CoV-2 infection displayed a rapid and profound decrease in platelets count and hemoglobin following admission [51.0 (127.0; 2.0)/ $\text{mm}^3$  and 1.4 g/dL (0.8; 2.1), respectively]. Specifically, monitoring of platelets count, hemoglobin levels and nucleated red blood cells during the first 28 days post hospitalization showed an increased RDW, MCV and the appearance of circulating erythroid progenitors. In silico interrogation pinpointed the expression of ACE2, CD13 and TMPRSS2 on megakaryocytes and erythroid progenitors. BM staining confirmed the presence of SARS-CoV-2 Spike protein in erythroid and megakaryocytes. Finally, the persistence of the SARS-CoV-2 Spike protein was detected in marrow precursors also in patients who recovered from infection. We showed that subjects with severe COVID-19 infection suffered from thrombocytopenia, anemia or bi-linear cytopenia and had increased RDW, MCV and erythroid precursors in peripheral blood, suggesting a direct or indirect detrimental effect of SARS-CoV-2 on thrombo- and erythropoiesis. The detection of SARS-CoV-2 Spike protein in BM precursors and its persistence after infection recovery, indi-

cate that the virus is capable of damaging marrow precursors also after the systemic clearance. Finally, the presence of Spike protein on BM precursors may suggest humoral/cellular autoimmune attack against these cells in patients seroconverted after COVID-19 and paves the way to studies on vaccine induced cytopenias.

### C39

#### DISSECTION OF BONE MARROW MICROENVIRONMENT BY SINGLE CELL RNA SEQUENCING IN WARM AIHA PATIENTS: A PROOF-OF-CONCEPT ANALYSIS

B. Fattizzo, M.C. Davià, J.A. Giannotta, A. Maeda, A. Marella, L. Baldini, N. Bolli, W. Barcellini

Dipartimento di Oncologia ed Emato-oncologia, Università degli Studi di Milano, Milano, Italy; UOC Ematologia, Fondazione IRCCS Ca' Granda Ospedale Maggiore Policlinico, Milano, Italy

**Introduction:** bone marrow (BM) compensation is important in warm type autoimmune hemolytic anemia (wAIHA) and preliminary studies showed that BM composition may predict anemia severity and treatment response. We aimed at dissecting BM environment by single cell RNA sequencing (scRNA-seq) in patients with wAIHA.

**Methods:** we collected bone marrow samples from 2 patients experiencing mild hemolytic reactivations handled with low dose steroids (M-AIHA) and 2 with severe relapses requiring high steroid doses and rituximab (S-AIHA). We performed scRNA-seq for 17,989 single cells, detecting over 23,446 expressed genes per cell on average.

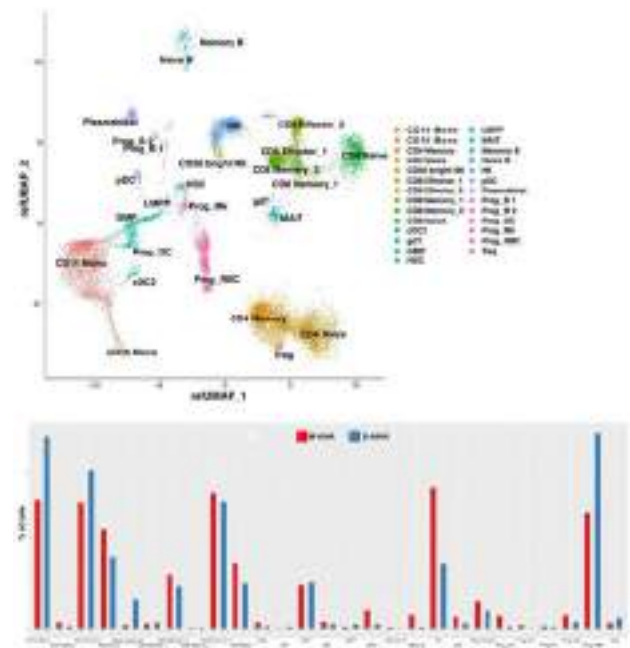

**Figure 1.** A. bone marrow microenvironmental cell composition by uniform manifold approximation and projection (UMAP) in wAIHA. B. percentages of different cell subpopulations in severe (blue) versus moderate (red) relapses of AIHA patients.

**Results:** Uniform manifold approximation and projection (UMAP), a method for nonlinear dimensionality reduction, showed the microenvironmental cell composition, including T-, B- and NK- lymphocytes and their subpopulations, plasma cells, CD14+ and CD16+ monocytes, hematopoietic stem cells, and myeloid precursors (Figure 1A). BM microenvironment showed a high frequency of innate immunity effectors such as NK cells and monocytes (11% and 15% of total cells), likely reflecting the inflammatory state typical of autoimmune/autoinflammatory response. T-cell subpopulations were also highly represented. Specifically, more CD4+ memory than CD4+ naive T-cells (58% vs

38%) were found, and T-regs represented a small fraction (4%). Also, CD8+ memory cells were more frequent than CD8+ naïve and CD8+ effectors (55% vs 24% vs 21%). Both CD8+ memory and effectors type 2 cells were higher than type 1 cells, indicating a likely participation of T cells in disease phenotype. B cells were particularly underrepresented, likely due to recent steroids/rituximab. S-AIHA patients showed higher CD14+ monocytes (57% vs 43%) and decreased NK cells (19% vs 81%) as compared to M-AIHA (Figure 1B). Finally, we found differential expression of genes related to T-cell receptor, immunoglobulins and interferon alpha/gamma response in T-cells, and downregulation of pathways related to immunomodulatory/inflammatory cytokines, complement activation and apoptosis in monocytes of S-AIHA versus M-AIHA.

**Conclusions:** These preliminary data show for the first time that scRNA-seq technology is feasible in wAIHA and gives insights in the pathogenic role of bone marrow immunologic microenvironment. Additionally, BM composition appears to dynamically modify according to disease severity and treatment.

## C40

### THE GENE PROMOTER BINDING ACTIVITY OF MIR-223 INDUCES FLOTILLIN-1 EXPRESSION AND FUNCTION TO REGULATE MYELOID DIFFERENTIATION

M. Billi<sup>1</sup>, A. Ianni<sup>2</sup>, A. Quattrocchi<sup>3</sup>, M. Gentile<sup>3</sup>, U. Borello<sup>2</sup>, F. Grignani<sup>1</sup>, C. Nervi<sup>3</sup>, E. De Marinis<sup>3</sup>

<sup>1</sup>General Pathology and Department of Medicine, University of Perugia; <sup>2</sup>Unit of Cellular and Developmental Biology, Department of Biology, University of Pisa; <sup>3</sup>Department of Medical-Surgical Sciences and Biotechnologies, University "La Sapienza", Italy

**Introduction:** Epigenetic signals and microRNA (miRNA) are key regulators of developmental cell programs, including hematopoietic cells lineage-specification and fate. Alteration of their function can induce neoplastic transformation. miRNAs mainly mediate the post-transcriptional gene silencing of target mRNAs. However, miRNAs bind also complementary DNA sequences at specific gene sites and participate in the epigenetic regulation of chromatin structure. The nuclear activity of miRNAs represents a new paradigm for non-coding RNA function in somatic stem cell proliferation, cell lineage specification and differentiation.

**Methods:** Genomic seeding and DNA sequences bound by miR-223 were identified genome-widely by ChIP-seq of Mimic miR-223-Cy5 transfected HL60 cells induced or not to granulocytic differentiation by retinoic acid (RA) treatment. MiR-223 and FLOT1 mRNAs were measured by ddPCR and RT-PCR; FLOT1 and CSF1R protein levels by Immunoblotting. Functional studies were carried out in myeloid cell lines by miR-223 or FLOT1 ectopic expression/silencing. Biological role of FLOT1 in myelopoiesis was evaluated in healthy donors' peripheral blood (PB)- and human umbilical cord blood (CB)-CD34+ hematopoietic progenitors (HPCs), undergoing successive developmental stages of myeloid differentiation/maturation. Cell immunophenotype was assessed by Flow Cytometry.

**Results:** We determined at the whole genome level in myeloid cells undergoing RA-induced myeloid differentiation, the gene promoter sequences bound by nuclear miR-223 characterized by activating (H3K4me3) and/or repressing (H3K27me3) histone marks. Among the complementary sequences bound by miR-223, we selected the Flotillin-1 (FLOT1) gene promoter, accompanied by a substantial increase in the positive H3K4me3 mark and paralleled by increased expression. FLOT1 encodes a lipid-rafts associated protein, whose role in normal and neoplastic hematopoiesis is mostly unknown. We found FLOT1 mRNA and protein levels highly induced in HPCs undergoing granulocytic differentiation, isolated from of healthy donors' PB and CB; FLOT1 expression is significantly altered in blood samples from acute myeloid leukemia patients analyzed from different TCGA datasets. Overexpression of FLOT1 enhances CSF1R protein levels after growth factor stimulation and also its recruitment to functional lipid rafts, whereas FLOT1 silencing significantly reduces the expression levels of surface markers CD11b and CD14 in RA treated cells.

**Conclusions:** Overall, these data suggest miR-223 as a regulator of

active chromatin-based pathways and identify FLOT1 gene promoter as a novel target of its nuclear activity. FLOT1 levels and function are found related to myelopoiesis and appear de-regulated in acute myeloid leukemia, thus opening novel insights into the molecular mechanisms leading to leukemia and for the design of new intervention strategies.

## Chronic Myeloproliferative Disorders 2

### C41

#### GENERATION AND CHARACTERIZATION OF CALRETICULIN KNOCK-OUT MICE

N. Bartalucci, L. Calabresi, M. Balliu, D. Tarantino, P. Guglielmelli, A.M. Vannucchi

*Centro Ricerca e Innovazione Malattie Mieloproliferative, Dipartimento di Medicina Sperimentale e Clinica, Università di Firenze, Italy*

**Introduction:** The three driver mutations (*JAK2*<sup>V617F</sup>, *MPL*<sup>W515K/L</sup> and *CALR*<sup>EXON9</sup>) of Philadelphia-negative Myeloproliferative Neoplasms (MPN) induce the dysregulation of JAK/STAT axis and result in the autonomous growth of one or more hematopoietic lineage. *JAK2* or *MPL* knock-out (KO) leads to the abrogation of hematopoiesis, conversely the role of Calreticulin (*CALR*) in hemopoiesis is still unknown, however recent reports demonstrated that *CALR* abrogation leads to neoplastic transformation (Shide K et al. *Blood*, 2020; Balliu M et al. *Blood Adv.*, 2021). To elucidate the role of *CALR* in hematopoiesis and MPN development, we generated and characterized a *CALR* KO mouse model.

**Methods:** We generated heterozygous *CALR* floxed C57Bl6 mice (*CALR*<sup>+/+</sup>), and a homozygous *CALR* floxed colony was obtained by mating heterozygous mice. Floxed mice were crossed with vav-Cre C57Bl6 to produce progenies with the *CALR*<sup>+/+</sup> and *CALR*<sup>-/-</sup> genotypes restricted to the hematopoietic tissue. Phenotypic characterization was carried out on 5 to 7 months old mice by blood counts, bone marrow (BM) and spleen histology, flow-cytometry, clonogenic assay of BM and spleen progenitors.

**Results:** Sanger sequencing of *CALR* KO mice showed the deletion of *CALR* exon 4-7 resulting in the absence of detectable *CALR* by western blotting. The progeny abundance, body weight and lifespan were comparable among *CALR*<sup>+/+</sup>, *CALR*<sup>+/-</sup> and *CALR*<sup>-/-</sup> mice. No significant difference was found among the three genotypes concerning blood counts. BM histology of *CALR* KO mice demonstrated the presence of megakaryocyte (Mk) clusters, absent in control BM. Semisolid culture of BM cells revealed an enhanced growth potential of *CALR*<sup>-/-</sup> compared to *CALR*<sup>+/+</sup> progenitors for both CFU-GEMM and CFU-GM colonies (1.6-fold, p=0.01 and 1.3-fold, p=0.008, respectively). The number of CFU-GM resulted 1.4-fold higher also in *CALR*<sup>+/-</sup> compared to controls (p=0.003). No significant difference was found concerning BFU-E. Such observations were corroborated by flow-cytometry data of BM cells that showed a 2 to 5-fold higher number of common myeloid progenitors (c-Kit<sup>+</sup>/FcgR<sup>+</sup>/CD34<sup>+</sup>) and a doubled number of myeloid cells (Mac1<sup>+</sup>/Gr1<sup>+</sup>) in both KO models compared to controls. *CALR* KO mice did not evidence splenomegaly at the autoptic inspection, however both *CALR*<sup>+/-</sup> and *CALR*<sup>-/-</sup> splenic tissue showed a progressive loss of organ architecture with a grade I fibrosis and the presence of Mk clusters. Clonogenic assay of KO spleen progenitors showed a trend to increased colonies growth compared to controls, statistically significant in *CALR*<sup>-/-</sup> progenitors (p=0.02 for CFU-GM, p=0.001 for BFU-E).

**Conclusion:** These initial observations need to be validated in a larger cohort of mice, especially for homozygous mice. However, the reported data suggest that deletion of Calreticulin in this in-vivo model leads to a dysregulation of hematopoiesis, ultimately resulting in an enhanced proliferation of myeloid precursors as usually observed in MPN.

### C42

#### A MULTIDISCIPLINARY DIAGNOSTIC APPROACH REVEALS A HIGHER PREVALENCE OF INDOLENT SYSTEMIC MASTOCYTOSIS: 15-YEARS' EXPERIENCE OF THE GISM NETWORK

L. Crosera<sup>1</sup>, I. Tanasi<sup>1,2</sup>, E. Lovato<sup>1</sup>, E. Tamellini<sup>1</sup>, A. Bernardelli<sup>1</sup>, C. Isolan<sup>1</sup>, F. Olivieri<sup>3</sup>, G. Orsolini<sup>2,4</sup>, D. Schena<sup>2,5</sup>, M. Bonifacio<sup>1,2</sup>, P. Bonadonna<sup>2,3</sup>, M. Krampera<sup>1</sup>, R. Zanotti<sup>1,2</sup>

<sup>1</sup>Hematology Unit, Department of Medicine, Azienda Ospedaliera Universitaria Integrata di Verona, Verona; <sup>2</sup>Gruppo interdisciplinare per lo studio della Mastocitosi (GISM), Azienda Ospedaliera Universitaria Integrata di Verona, Verona; <sup>3</sup>Allergy Unit, Department of Medicine,

Azienda Ospedaliera Universitaria Integrata di Verona, Verona; <sup>4</sup>Rheumatology Unit, Department of Medicine, Azienda Ospedaliera Universitaria Integrata di Verona, Verona; <sup>5</sup>Dermatology Unit, Department of Medicine, Azienda Ospedaliera Universitaria Integrata di Verona, Verona, Italy

**Background:** Clonal mast cells disorders (CMD) comprise a heterogeneous group of diseases including indolent systemic mastocytosis (ISM) and its subvariant without skin involvement (bone marrow mastocytosis, BMM), smoldering SM (SSM), and advanced SM variants. Clinical presentation and complications may be heterogeneous and require a multidisciplinary approach. The WHO diagnostic criteria of SM include one major (histological) and four minor (morphological, aberrant immunophenotype, cKIT mutation and high serum tryptase) criteria. Diagnosis requires the major and one minor criterion, or three minor criteria. In recent years, the improved knowledge of this disease has led to the creation of networks of specialists aimed at a better management of CMD patients. SM and adult CMD are considered rare diseases. Nevertheless, epidemiological data are scarce: to date, the prevalence of adult SM has been reported of 10-13 per 100,000 inhabitants. Moreover, there is a lack of consensus on the prevalence of different SM variants in the main literature series.

**Aim and methods:** The aim of this retrospective, single-center study, was to evaluate the impact of the diagnostic techniques used in the Interdisciplinary Group for the Study of Mastocytosis (GISM) of Verona on the prevalence and incidence of CMD. We analyzed 502 patients aged >14 years, residing in the Veneto Region, consecutively referred to GISM and diagnosed with CMD from 2006 to 2020. In all patients bone marrow (BM) biopsy, morphologic examination of BM smear, detection of the D816V KIT mutation with allele-specific ARMS-RT-qPCR on BM samples and multiparameter flow-cytometric evaluation of BM mast cells were performed.

**Results:** SM was diagnosed in 431 patients (85.8%), while the remaining had insufficient criteria for SM diagnosis and were classified as other CMD. The prevalence of SM in the adult population of the Veneto region and the Verona province were 10.2 and 17.2/100.000 inhabitants, respectively. The mean incidence of new SM cases in Verona was 1.09/100.000 inhabitants/year. ISM was by far the most frequent SM variant (n=392, 91.0%): of them, 236 patients (54.8%) had BMM. While 100% of patients with SSM or advanced SM fulfilled the major criterion, the diagnosis of ISM and BMM was made by means of minor criteria only in 44% and 64% of cases, respectively. Anaphylaxis was the main reason (50%) leading to SM diagnosis and osteoporosis, often complicated by fragility fractures, was present in 35% of cases.

**Conclusions:** Our data show a higher prevalence of SM than previously reported and underline the importance of employing sensitive diagnostic techniques to highlight the minor criteria in patients with low mast cell burden. Referring patients to specialized centers with multidisciplinary groups increases the likelihood of diagnosing underestimated variants of SM such as BMM, and can help in the management of related complications.

**Table 1.** Comparison between the frequencies of the variants of systemic mastocytosis in the present study and those reported in the main series of literature.

	Lin et al (Blood, 2009)	Sarkar et al (Mod Pathol, 2012)	Winters et al (Int Arch Allergy Immunol, 2013)	Calvo et al (Br J Haematol, 2014)	Poon et al (Am J Hematol, 2016)	Sperr et al (Leuk Res, 2017)	GDG Veneto (2021)
<b>Systemic Mastocytosis</b>							
ISM <sup>a</sup>	119	35	11	206	43	100	302
%	(46.5)	(52.1)	(82.6)	(82.1)	(99.13)	(75.1)	(69.3)
SSM <sup>b</sup>	16	16	0	0	143	208	236
%	(18.5)	(18.1)	0	0	(11.9)	(17.4)	(54.8)
BMM <sup>c</sup>	22	0	7	0	28	51	5
%	(8.4)	0	(2.1)	0	(12.3)	(16.9)	(1.3)
ASM <sup>d</sup>	11	11	0	0	0	62	0
%	(13.8)	(15.7)	0	0	0	(14.7)	0
SM-AHN <sup>e</sup>	119	0	11	24	26	214	21
%	(46.5)	(0)	(82.6)	(11.8)	(44.4)	(13.2)	(6.1)
MCL <sup>f</sup>	4	2	1	5	1	25	0
%	(1.1)	(2.9)	(7.1)	(2.1)	(0.4)	(1.7)	0
<b>Total</b>	<b>252</b>	<b>113</b>	<b>18</b>	<b>235</b>	<b>177</b>	<b>418</b>	<b>331</b>

**ASM:** aggressive systemic mastocytosis; **BMM:** bone marrow mastocytosis; **ISM:** indolent systemic mastocytosis; **MCL:** mast cell leukemia; **SM-AHN:** systemic mastocytosis with associated hematological neoplasm; **SSM:** smoldering systemic mastocytosis.

## C43

DROPLET DIGITAL PCR: GREATER PRECISION AND ROBUSTNESS THAN QUANTITATIVE REAL TIME PCR IN THE MEASUREMENT OF LOW-ALLELE *JAK2* V617F FREQUENCIES

F. Gesullo<sup>1</sup>, C. Mannarelli<sup>1</sup>, C. Maccari<sup>1</sup>, A. Lagrotteria<sup>1</sup>,  
A.M. Vannucchi<sup>1</sup>, P. Guglielmelli<sup>1</sup>

<sup>1</sup>Center Research and Innovation of Myeloproliferative Neoplasms, Azienda Ospedaliera Universitaria Careggi, University of Florence, Italy

**Introduction:** Myeloproliferative neoplasms (MPNs) are a heterogeneous group of diseases that originate in multifunctional hematopoietic stem cells and are characterized by the abnormal clonal proliferation of myeloid hematopoietic cells. Classical Philadelphia-chromosome-negative MPNs include polycythemia vera (PV), essential thrombocythemia (ET), and primary myelofibrosis (PMF). *JAK2* V617F is the most common mutation in MPNs and is a major diagnostic criterion (Erber et al, 2016). Mutation quantification is useful for classifying patients with MPN into subgroups and for prognostic prediction. Although widely used for detection of *JAK2* V617F mutation in peripheral blood (PB), sensitive real-time quantitative PCR (qPCR) presents some limitations. Recently, emerging alternative technologies, like digital droplet PCR (ddPCR), have been reported to overcome some of qPCR's technical drawbacks. The purpose of this study was to compare the diagnostic utility of ddPCR and qPCR for *JAK2* V617F detection and quantification in samples from MPNs patients.

**Methods:** We analyzed by ddPCR 171 MPN pts, with an already known mutational profile of *JAK2* V617F by qPCR in peripheral blood granulocytes (GN). In the same cohort, we investigated paired samples (PB and GN) of 21 pts with qPCR and ddPCR to determine the correlation between assays and establish a detection sensitivity cut-off. Correlation coefficients were calculated by a Spearman rank correlation coefficient analysis. Statistical analyses were conducted with SPSS version 21 software.

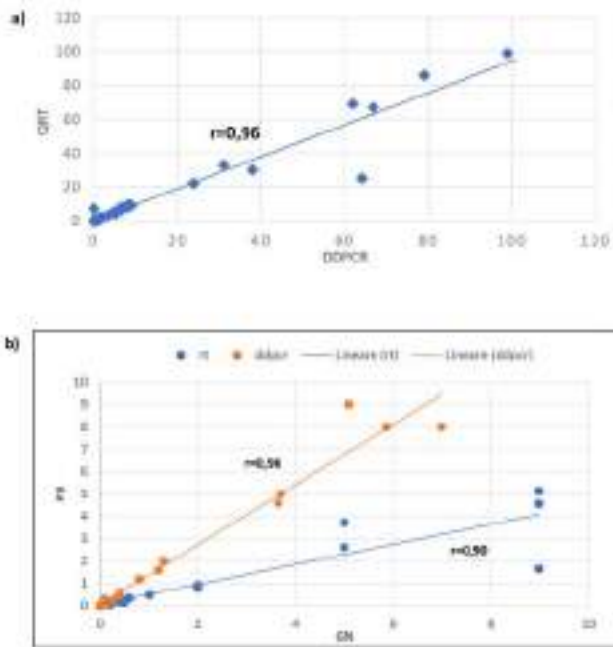

Figure 1. a) Correlation on GN between qPCR and ddPCR; b) Comparison GN and PB between qPCR and ddPCR.

**Results:** The correlation coefficient in GN samples between methods was  $r=0.96$  (Figure 1a). The analysis showed a moderate concordance between qPCR and ddPCR, while comparison between paired samples (PB and GN) of 21 pts showed a major correlation in ddPCR than qPCR ( $r=0.98$  vs  $r=0.90$ , Figure 1b): qPCR underestimate allele burden on PB. Then we selected 13 samples reported with qPCR in the “grey zone”,

defined as a VAF below limit of detection (LOD), but above limit of blank and presenting a percentage of mutant allele with qPCR from 0.05 to 0.1%. ddPCR of these “grey zone samples” did not detect any *JAK2* V617F positive droplets. For determination of false-negative rate, 80 pts previously defined negative by qPCR were analyzed with ddPCR. These samples were also negative with ddPCR. For determination of assay performance, the WHO Reference Panel of seven freeze-dried genomic DNA samples with different percentages of *JAK2* V617F mutation was used as calibrator panel. Three replicates for each sample concentration were analyzed, detecting a LOD of 0.05% for qPCR and 0.01% for ddPCR.

**Conclusion:** The detection of a *JAK2* V617F mutation at low levels is often too complex to be interpreted in clinical routine, and such determination is inevitably affected by the methodology used for molecular variant detection and quantification. ddPCR can achieve accurate absolute quantitative detection of the *JAK2* V617F mutation burden representing a clinically meaningful improvement over qPCR.

## C44

## EARLY DETECTION OF LEUKEMIC CLONES IN MPN PATIENTS THROUGH SINGLE-CELL GENOMIC ANALYSIS

C. Carretta<sup>1</sup>, S. Parenti<sup>1</sup>, S. Mallia<sup>1</sup>, S. Rontauroli<sup>1</sup>, C. Chiereghin<sup>2</sup>,  
S. Castellano<sup>3</sup>, E. Bianchi<sup>1</sup>, E. Genovese<sup>1</sup>, S. Sartini<sup>1</sup>, L. Tavernari<sup>1</sup>,  
M. Mirabile<sup>1</sup>, M.G. Della Porta<sup>4</sup>, R. Manfredini<sup>1</sup>

<sup>1</sup>Center for Regenerative Medicine “S. Ferrari”, University of Modena and Reggio Emilia; <sup>2</sup>Humanitas Clinical and Research Center-IRCCS; <sup>3</sup>Center for Genome Research, University of Modena and Reggio Emilia; <sup>4</sup>Humanitas Clinical and Research Center-IRCCS Rozzano, and Department of Biomedical Sciences, Humanitas University, Italy

**Introduction:** Myeloproliferative neoplasms (MPNs) are a group of hematopoietic stem cell disorders resulting in the overproduction of myeloid differentiated cells. Primary Myelofibrosis (PMF) is characterized by the worst prognosis and 15-20% of cases develop secondary Acute Myeloid Leukemia (AML). MPNs driver mutations affect *JAK2*, *CALR* or *MPL* genes. Moreover, mutations in epigenetic regulators generate a complex phenotype. Our recent work demonstrated through single cell analysis that MPNs progression is due to increased genetic heterogeneity, loss of heterozygosity and parallel AML evolution.

**Methods:** In order to describe the clonal hierarchy at the single cell level we employed Mission Bio Tapestry platform. We designed a 239-amplicon custom panel including 29 genes frequently mutated in myeloid neoplasms. Then, we analyzed the CD34+ compartment of 3 patients during the chronic phase of the disease and after leukemic transformation. These data were analyzed with Tapestry Pipeline and Tapestry Insights software in order to reconstruct the mutational phylogenetic tree. Mutation calls were filtered based on read depth and quality. CNV assessment was conducted through Mosaic algorithm.

**Results:** Patient #1 suffered from *CALR*-mutated Essential Thrombocythemia (ET) which evolved to AML. Clonal hierarchy reconstruction demonstrated that the first mutational hit affected *TET2* gene, while *CALR* variant was subclonal. Leukemic transformation was driven by the expansion of a clone harbouring *TP53* homozygous mutation. Patient #2 suffered from *CALR*-mutated PMF and subsequently progressed to AML. The first mutational hit affects the chromatin remodeler *ASXL1*. *CALR* mutation was found to be subclonal. The *KRAS*-mutated branch expanded during leukemic transformation. Notably, single cell analysis, unlike bulk NGS, detected these clones in PMF-phase. Patient #3 suffered from *JAK2*-mutated ET that evolved to AML. Even in this case, the first mutation acquired involved *ASXL1* gene and once again *JAK2* mutation was subclonal. Leukemic evolution is triggered by a mutation in *IDH2*, already detectable in a small clone in T1. This variant was not detected in chronic phase by bulk sequencing. In all patients, CNV analysis highlighted the greater gene dosage imbalance in the leukemic clones when compared with those in the chronic phase.

**Conclusions:** Altogether this analysis suggests that the first mutational hit frequently occurs in chromatin remodeler genes and affects a large fraction of neoplastic cells, confirming their impact on MPNs

pathogenesis. Moreover, clones carrying driver mutations remain stable during time and they don't seem to drive leukemic transformation. On the other hand, genetic alterations, such as SNVs and CNVs, driving AML evolution are early identified by single cell analysis despite being undetectable by bulk sequencing.

#### C45

##### SETD2 IS A BONA FIDE TUMOR SUPPRESSOR IN SYSTEMIC MASTOCYTOSIS

M. Mancini<sup>1</sup>, C. Monaldi<sup>2</sup>, S. De Santis<sup>2</sup>, C. Papayannidis<sup>1</sup>, M. Rondoni<sup>3</sup>, C. Sartor<sup>1</sup>, S. Bruno<sup>2</sup>, A. Curti<sup>1</sup>, R. Zanotti<sup>4</sup>, M. Bonifacio<sup>4</sup>, L. Scaffidi<sup>5</sup>, L. Pagano<sup>5</sup>, M. Criscuolo<sup>5</sup>, F. Ciceri<sup>6</sup>, C. Elena<sup>7</sup>, P. Tosi<sup>8</sup>, P. Valent<sup>9</sup>, M. Cavo<sup>1,2</sup>, S. Soverini<sup>1</sup>

<sup>1</sup>IRCCS Azienda Ospedaliero-Universitaria di Bologna, Istituto di Ematologia "Seràgnoli"; <sup>2</sup>Department of Experimental Diagnostic and Specialty Medicine - DIMES, Institute of Hematology "L. e A. Seràgnoli", University of Bologna; <sup>3</sup>Azienda USL della Romagna; <sup>4</sup>Azienda Ospedaliera di Verona; <sup>5</sup>Fondazione Policlinico Universitario A. Gemelli; <sup>6</sup>Servizio Immunoematologia Trasfusionale (SIMT), IRCCS Ospedale San Raffaele; <sup>7</sup>Fondazione I.R.C.S.S. Policlinico San Matteo; <sup>8</sup>U. O. di Oncologia ed Oncoematologia-Osp. Infermi Azienda Unità Sanitaria-Locale di Rimini; <sup>9</sup>Department of Hematology, Internal Medicine I, Medical University of Vienna

**Introduction:** H3K36me3 is a post-translational modification involved in the recruitment of DNA repair machinery. Recent studies have emphasized the tumor-suppressive role of H3K36me3, especially in renal cancer, where the gene coding for the SETD2 histone methyltransferase, the predominant writer of the trimethyl mark on H3K36, is often deleted or mutated. SETD2 non genomic loss of function due to proteasome-mediated degradation has recently been reported in advanced systemic mastocytosis (advSM). Proteasome inhibition has been found to rescue H3K36me3, inhibit clonogenic growth and induce apoptosis, but whether this is due to SETD2 re-expression remains to be demonstrated.

**Methods:** The SETD2-deficient HMC-1.2 mast cell leukemia cell line was used as in vitro model. Forced SETD2 re-expression was obtained by nucleofection: 106 HMC-1.2 cells were resuspended in 85µl of cell line Nucleofector Solution V and 2µg of a SETD2 (GFP-tagged) construct were added. An empty vector coding for GFP was used as negative control. Cells were transfected by using the Lonza Nucleofector 2b and the Lonza Amaxa Cell Line Nucleofector Kit V according to manufacturer's instructions. GFP expression was assessed using a Cytoflex flow cytometer 24 and 48 hours post transfection; 78% of fluorescence positivity was observed at 48 hours. Neomycin selection (1mg/ml) was performed to obtain stable SETD2 expression. One month after selection, SETD2 and H3K36me3 were assessed by Western Blotting (WB). Clonogenic capacity was tested by clonogenic assays.

**Results:** We previously characterized the HMC-1.2 cell line as deficient for SETD2/H3K36me3, as virtually all patients with advSM. To investigate whether SETD2 may indeed play a tumor suppressor role in SM, we transfected HMC-1.2 cells with an ectopic SETD2 plasmid. After transfection, the morphology of cells dramatically changed; moreover, HMC-1.2tsSETD2 showed a 70% increase in doubling time. Co-immunoprecipitation demonstrated that tsSETD2 was able to interact with p53 and to restore its expression and activity. We thus observed an increase in p21 and p27 associated with an accumulation of cells at the G1/S checkpoint. Moreover, SETD2 stable transfection restored DNA damage responses, as demonstrated by an increase in H2AX phosphorylation and RAD51 (HR) and MSH6 (MMR) expression after UV exposure. Finally, clonogenic assays in control and HMC-1.2tsSETD2 cells showed that: 1) SETD2 re-expression restores cell proliferation control; 2) reduction of clonogenic growth observed after proteasome inhibition is indeed SETD2-dependent.

**Conclusions:** In advSM, SETD2 is a bona fide tumor suppressor and its loss impairs proliferation control and DNA damage responses. Its overexpression restores cell proliferation control by stabilizing p53 activity, and DNA damage repair by rescuing the H3K36me3 mark. This validates the therapeutic potential of interfering with the mechanisms responsible for SETD2 loss. Supported by AIRC IG 2019 grant (23001).

#### C46

##### HIGH-QUALITY STANDARDIZED MINIMAL RESIDUAL DISEASE (MRD) MONITORING FOR CHRONIC MYELOID LEUKEMIA PATIENTS: THE EXPERIENCE OF THE LABNET CML NATIONAL NETWORK

F. Pane<sup>1</sup>, R. Cucci<sup>2</sup>, M. Messina<sup>2</sup>, M. Breccia<sup>3</sup>, S. Galimberti<sup>4</sup>, G. Martinelli<sup>5</sup>, G. Rosti<sup>5</sup>, F. Albano<sup>6</sup>, P. Vigneri<sup>7</sup>, G. Saglio<sup>8</sup>, S. Soddu<sup>2</sup>, A. Piciocchi<sup>2</sup>, B. Izzo<sup>9</sup>, E. Gottardi<sup>10</sup>, E. Ottaviani<sup>11</sup>, P. Fazi<sup>2</sup>, M. Vignetti<sup>2</sup>, M. Baccarani<sup>12</sup>

<sup>1</sup>UOC Ematologia e Trapianti di Midollo, AOU "Federico II", Napoli; <sup>2</sup>Fondazione GIMEMA Franco Mandelli Onlus, Roma; <sup>3</sup>Dipartimento di Medicina Traslazionale e di Precisione, Università "Sapienza", Roma; <sup>4</sup>Dipartimento di Medicina Clinica e Sperimentale, Università di Pisa, Pisa; <sup>5</sup>IRCCS Istituto Romagnolo per lo Studio dei Tumori (IRST) "Dino Amadori", Meldola (FC); <sup>6</sup>UOC Ematologia con Trapianto, Policlinico di Bari, Bari; <sup>7</sup>Dipartimento di Medicina Clinica e Sperimentale, Università di Catania, Catania; <sup>8</sup>Dipartimento di Scienze Cliniche e Biologiche, Università di Torino, Torino; <sup>9</sup>Dipartimento di Medicina Molecolare e Biotecnologie Mediche e CEINGE Biotecnologie Avanzate; <sup>10</sup>AOU San Luigi Gonzaga, SCU Ematologia generale e Oncoematologia, Orbassano; <sup>11</sup>AOU di Bologna, Policlinico S. Orsola-Malpighi, Bologna; <sup>12</sup>Istituto di Ematologia "Lorenzo e Ariosto Seràgnoli", Università di Bologna, Bologna, Italy

**Introduction:** MRD monitoring in CML is based on the quantification of the *BCR/ABL1* fusion transcript by real-time quantitative PCR (RQ-PCR) and requires specialized molecular biology laboratories. Moreover, these laboratories need to adhere to the same standardized technique to guarantee comparable results across laboratories and across samples analyzed. To deal with these issues, in 2014 GIMEMA – with an unconditional grant from Novartis – launched LabNet CML in order to: i) set-up a network of laboratories specialized in diagnosis and MRD monitoring in CML patients well distributed over Italy, ii) harmonize the methods, iii) implement the international scale to the laboratories of the network, iv) broaden the number of specialized laboratories, v) guarantee all CML patients - regardless of the treating institution - a high-level disease monitoring. To participate in the network, laboratories fulfilled quality controls and regularly undergo standardization procedures. The connection between the hematology centers and laboratories is managed by a web-based GDPR compliant platform that allows to i) request molecular tests, ii) share results, iii) archive the results. Besides delivering a health service, this platform also allowed the acquisition of MRD data on a very large cohort of patients. Therefore, since the prognostic impact of the type of *BCR/ABL1* transcript is still controversial, we analyzed the achievement of a deep molecular response (*i.e.* MR<4.0, DMR) in the different *BCR/ABL1* subtypes.

**Methods:** Data were exported on the 10th of September 2021 and those concerning the transcript level over time were analyzed.

**Results:** At the time of the analysis, the network included 55 active reference laboratories - covering the entire Italian territory - and 123 hematology centers. Overall, 9358 patients were registered in the platform: of them, 3161 (34%) harbored the b3a2, 1600 (17%) the b2a2, 994 (11%) the b2a2 and b3a2 isoforms, 25 (0.3%) the e1a2, 11 (0.1%) the e19a2 isoform. The remaining patients carried other isoforms 546 (5.8%) or this information was not reported. A total of 145460 requests of exams were managed and 109619 samples were analyzed. Patients with at least one sample with a DMR were 6540/9358 (68.9%). Interestingly, deep responders were not equally distributed across transcript subtypes: indeed, 3222/4155 (77.5%) of patients harboring either the b3a2 or b2a2/b3a2 isoforms achieved a DMR while only 901/1600 (56.3%) of patients carrying the b2a2 obtained a DMR.

**Conclusions:** Starting from 2014 the LabNet CML network provided an accurate MRD monitoring of disease to roughly 10000 CML patients in the whole Italian territory. The management of these exams through the LabNet network led to a harmonization of procedures and optimization of the National Health Services resources. Moreover, the first analysis of this invaluable database showed that CML patients expressing either the b3a2 or b2a2/b3a2 isoforms are more likely to achieve a DMR.

**C47**

**SETD2 LOSS OF FUNCTION IS AN INTRINSIC CHARACTERISTIC OF CD34+ PROGENITORS OF CML PATIENTS, SUSTAINS GENOMIC INSTABILITY AND ENHANCES THEIR CLONOGENIC POTENTIAL**

M. Mancini<sup>1</sup>, S. De Santis<sup>2</sup>, C. Monaldi<sup>2</sup>, S. Bruno<sup>2</sup>, F. Castagnetti<sup>2</sup>, G. Gugliotta<sup>1</sup>, A. Iurlo<sup>3</sup>, M. Cerrano<sup>4</sup>, S. Galimberti<sup>5</sup>, S. Balducci<sup>5</sup>, F. Stagno<sup>6</sup>, G. Rosti<sup>1</sup>, M. Baccarani<sup>2</sup>, M. Cavo<sup>1,2</sup>, S. Soverini<sup>1</sup>

<sup>1</sup>IRCCS Azienda Ospedaliero-Universitaria di Bologna, Istituto di Ematologia “Seràgnoli”; <sup>2</sup>Dipartimento di Medicina Specialistica, Diagnostica e Sperimentale, Università di Bologna; <sup>3</sup>UO Onco-ematologia, Fondazione IRCCS Ca’ Granda - Ospedale Policlinico; <sup>4</sup>O.U. Città della Salute e della Scienza di Torino; <sup>5</sup>Clinical and Experimental Medicine, Hematology, University of Pisa; <sup>6</sup>Ematologia Universitaria e Trapianto Midollo Osseo, Ospedale Gaspare Rodolico, Italy

**Introduction:** Genomic instability results from aberrant or inefficient cellular response to enhanced DNA damage. It is a hallmark of chronic myeloid leukemia in chronic phase (CML-CP) and results in BCR-ABL1 mutations inducing resistance to tyrosine kinase inhibitors (TKIs) and/or additional chromosomal aberrations leading to disease relapse and/or malignant progression. SETD2, the enzyme that trimethylates histone H3 lysine 36 (H3K36me3), is required for homologous recombination (HR) repair of double strand breaks (DSBs) by promoting the formation of RAD51 presynaptic filaments and for DNA mismatch repair (MMR). Accordingly, cells characterized by SETD2 loss of function displayed impaired DNA damage signaling. We have already reported that virtually all CML patients (pts) in blast crisis display SETD2 loss of function that accounts for their genomic instability. We thus set out to investigate whether CD34+ progenitors of CML-CP pts, known to be equally characterized by enhanced genomic instability, also show SETD2 loss of function.

**Methods:** Protein expression and activation was assessed by Western blotting (WB). SETD2 forced expression was obtained by using Nucleofector technology. 106 cells were suspended in 80 µl of transfection reagent, and 2 µg of a SETD2 (GFP-tagged) construct were added. The cells were subjected to electroporation using the Lonza Nucleofector 2b Unit with the Lonza P3 Primary Cell Nucleofector X Kit S according to the Lonza Amaxa 4D-Nucleofector Protocol for unstimulated CD34+ cells. Reporter gene (GFP) expression levels were quantified using flow cytometry 48 hours post transfection, and SETD2 re-expression and reactivation were confirmed by WB. Clonogenic capacity was evaluated by clonogenic assays.

**Results:** Loss of SETD2 protein expression and function (assessed using loss of H3K36me3 as surrogate marker) were detected by WB in the CD34+ cell fraction of 20 newly diagnosed CML-CP pts, as compared to the total mononuclear cell fraction or to the CD34+ fraction obtained from a pool of healthy donors. CML progenitor cells displaying SETD2 loss of function accumulate genetic and genomic aberrations, which was evidenced by hyper-phosphorylation of H2AX and overexpression of RAD51 (HR) and MSH6 (MMR). To assess if the forced overexpression of the SETD2 gene may restore proliferation control CD34+ cells from 5 CML-CP pts were transfected. In all cases, subsequent clonogenic assays showed a >50% reduction in clonogenic potential.

**Conclusions:** Our results demonstrate that SETD2 behaves like a true tumor suppressor in CD34+ progenitor cells of CP-CML pts. Its loss of function is responsible for genetic/genomic instability, while its overexpression restores cell proliferation control.

Supported by AIRC IG 2019 grant (23001) and Italian Ministry of Health, “Bando Ricerca Finalizzata 2016”, project GR-2016-02364880.

**C48**

**A NOVEL, RAPID AND STRAIGHTFORWARD DROPLET DIGITAL PCR (DDPCR) STRATEGY FOR THE DETECTION OF BCR-ABL1 KINASE DOMAIN (KD) MUTATIONS IMPACTING ON TYROSINE KINASE INHIBITOR (TKI) SELECTION IN PHILADELPHIA CHROMOSOME-POSITIVE PATIENTS**

S. Soverini<sup>1</sup>, S. De Santis<sup>1</sup>, C. Monaldi<sup>1</sup>, M. Martelli<sup>1</sup>, M. Mancini<sup>2</sup>, S. Bruno<sup>1</sup>, F. Castagnetti<sup>1,2</sup>, G. Gugliotta<sup>2</sup>, G. Rosti<sup>2</sup>, C. Papayannidis<sup>2</sup>, A. Curti<sup>2</sup>, K. Machova Polakova<sup>3</sup>, T. Ernst<sup>4</sup>, D. Maar<sup>5</sup>, A. Corner<sup>6</sup>, M. Cavo<sup>1,2</sup>

<sup>1</sup>Dipartimento di Medicina Specialistica, Diagnostica e Sperimentale (DIMES), Istituto di Ematologia “Seràgnoli”, Università di Bologna; <sup>2</sup>IRCCS Azienda Ospedaliero-Universitaria di Bologna, Istituto di Ematologia “Seràgnoli”; <sup>3</sup>Institute of Hematology and Blood Transfusion; <sup>4</sup>Abt. Hämatologie und Internistische Onkologie, Klinik für Innere Medizin II, Universitätsklinikum Jena; <sup>5</sup>Bio-Rad Laboratories, Digital Biology Group UK; <sup>6</sup>Bio-Rad Laboratories, Digital Biology Group US

**Introduction:** BCR-ABL1 KD mutation testing is recommended in all patients (pts) with non adequate response to TKI therapy. Acknowledging the importance of sensitive and accurate mutation detection, the 2020 ELN recommendations have endorsed the use of NGS. However, NGS is time consuming, technically demanding and requires centralization of samples for cost effectiveness. In this study, we evaluated a novel ddPCR-based multiplex strategy designed to screen for a panel of BCR-ABL1 KD mutations impacting on 2nd-generation TKI (2GTKI) selection.

**Methods:** In collaboration with Bio-Rad, a 3-tube strategy was designed that enables the identification and quantitation of 16 nucleotide substitutions (Table 1) encoding the mutations known to be associated with resistance to one or more 2GTKIs. Multiplexing and experimental conditions were optimized so that mutations generated clusters of droplets mapping to spatially distinct areas of the 2D plot based on their resistance profile (Figure 1A, B, C). Each tube also incorporated primers and probes for the e13a2, e14a2 and e1a2 BCR-ABL1 fusion transcripts, serving as a control. For validation, a total of 101 RNA samples from healthy donors, TKI-sensitive and resistant pts, BCR-ABL1-positive and -negative cell lines were used. RNA was reverse transcribed to cDNA using ABL1-specific primers and the iScript cDNA synthesis kit; 100ng of cDNA were then tested in duplicate on a QX200 ddPCR system using the ddPCR Multiplex Supermix (all from Bio-Rad).

Figure 1 and Table 1.

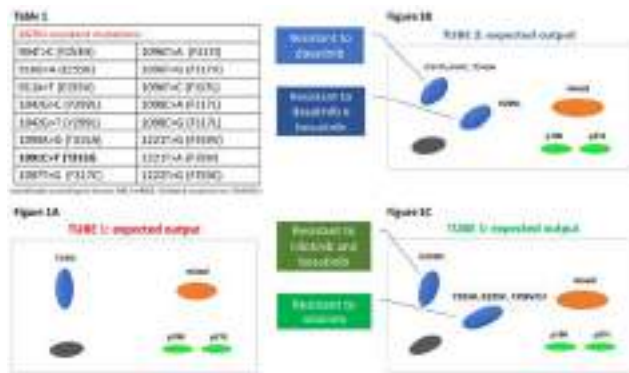

**Results:** The limit of blank (LOB), calculated in 60 blank samples, was estimated to be 0.13 copies/uL for tube 1 and 0.18 copies/uL for tube 3. Tube 2 systematically yielded an aspecific cluster of droplets above the double negative cluster which required the FAM threshold to be set to 6,000; using this threshold, no false positive droplets could be detected in the top right and left quadrants, thus LOB was estimated as 0. To validate the assays, 41 samples positive (by NGS) for each of the 16 nucleotide substitutions at varying frequencies were tested. In each sample, the expected mutation(s) was/were successfully detected and no

false negative results or cross-reactivity occurred. Titration series prepared mixing HL-60, mutated (T315I, E255K, E255V, Y253H) and wild-type KCL-22, T1 or BaF3 cells to mimic not only different mutation frequencies (50%, 10%, 1%, 0.1%) but also different transcript levels (down to 0.1%) showed sensitive mutation detection and consistent quantitation across a range of BCR-ABL1/ABL1<sup>IS</sup> levels.

**Conclusions:** The 3-tube multiplex ddPCR strategy proved to be accurate in detecting and quantitating all the mutations associated with 2GTKI resistance. Max limit of detection (LOD) was 0.1%, total hands-on time was approximately 2 hours and time from sample to results was as short as 2 days. ddPCR holds the potential to democratize sensitive BCR-ABL1 mutation testing, enabling timely and rational therapeutic reassessment in CML and Ph+ ALL TKI-resistant pts.

## Plasma Cell Dyscrasias 2

C49

### THE ROLE OF CD56 EXPRESSION IN SMOLDERING MULTIPLE MYELOMA

L. Notarfranchi<sup>1</sup>, P. Storti<sup>1</sup>, R. Vescovini<sup>1</sup>, R. Segreto<sup>2</sup>, S. Bonomini<sup>2</sup>, G. Sammarelli<sup>2</sup>, G. Todaro<sup>2</sup>, V. Raimondi<sup>1</sup>, J. Burroughs-Garcia<sup>1</sup>, D. Toscani<sup>1</sup>, A.B. Dalla Palma<sup>2</sup>, N. Giuliani<sup>1,2</sup>

<sup>1</sup>Dipartimento di Medicina e Chirurgia, Università di Parma; <sup>2</sup>Ematologia, Azienda Ospedaliero-Universitaria, Italy

The identification of risk factors for progression is critical in the management of Smoldering Multiple Myeloma (SMM) patients. The early identification of patients with possible short-term progression to Multiple Myeloma (MM) could lead to anticipate the treatment. Several prognostic score identify the main risk factors for progression but the two most used models are the Mayo Clinic “20-2-20”, and the Spanish PETHEMA group model. However, significant discrepancies between these two clinical models have been underlined. For this reason, new parameters need to be defined. Recently, flow cytometry technique has been increasingly used in the setting of MM to establish the phenotype of pathological plasma cells (PCs). For example, CD56, a neural cell adhesion and also a marker of NK cells, is normally overexpressed in myeloma cells. Despite this, different studies demonstrated that a lack of CD56 in pathological PCs is associated with a poorer outcome. Therefore we decided to investigate the possible role of the CD56 expression as risk factor for progression. We retrospectively evaluated a cohort of SMM patients admitted to the Hematology Unit of Parma between 2014 and 2019. We analyzed a total cohort of 80 SMM patients diagnosed according to the IMWG criteria. All patients analyzed underwent to Bone Marrow (BM) examination and imaging evaluation was performed in order to exclude the presence of bone disease and/or focal lesions. Both immunophenotypic and FISH analysis were performed of BMPCs. Statistical analyses were done through *PRISM software* and results had been considered significant at  $p \leq 0,05$ . Overall, 26 patients progressed to MM with a median time to progression (TTP) of 23,5 months. Firstly, we divided the population based on the expression of CD56 and we found that TTP in CD56- patients was shorter than TTP in CD56+ ones (11 vs 31 months,  $p=0,04$ , *Kaplan Meier survival curve*, Figure 1).

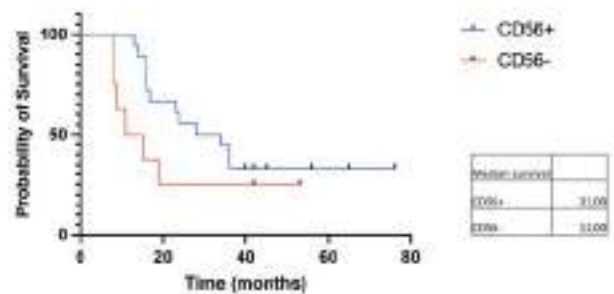

Figure 1.

In conclusion, our study identified the loss of CD56 as a possible risk factor for early progression in SMM patients. Indeed, the loss of CD56 expression could be a factor for a more aggressive disease regardless to the tumoral burden. For this reason, the expression of CD56 should be incorporated in future predictive scores.



**C50****TRANSACTIVATION OF LINC RNA NEAT1 PROVIDES PRO-ONCOGENIC POTENTIAL AND INDUCES RESISTANCE MECHANISMS IN MM CELLS: RATIONAL BASES FOR NEAT1 THERAPEUTIC TARGETING IN THE DISEASE**

E. Taiana<sup>1,2</sup>, V.K. Favasuli<sup>1,2</sup>, I. Silvestris<sup>1,2</sup>, N. Puccio<sup>1,2</sup>, D. Ronchetti<sup>1,2</sup>, K. Todoerti<sup>1,2</sup>, C. Bandini<sup>3,4</sup>, I. Craparotta<sup>5</sup>, L. Di Rito<sup>5</sup>, S. Erratico<sup>6</sup>, N. Platonova<sup>7</sup>, R. Piva<sup>3,4</sup>, M. Bolis<sup>5</sup>, Y. Torrente<sup>8</sup>, R. Chiamonte<sup>7</sup>, L. Baldini<sup>1,2</sup>, A. Neri<sup>1,2</sup>

<sup>1</sup>Hematology, Fondazione Cà Granda IRCCS Policlinico, Milan; <sup>2</sup>Department of Oncology and Hemato-oncology, University of Milan, Milan; <sup>3</sup>Department of Molecular Biotechnology and Health Sciences, University of Torino, Torino; <sup>4</sup>Città Della Salute e della Scienza Hospital, Torino; <sup>5</sup>Computational Oncology Unit, Oncology Department, Mario Negri IRCCS, Milan; <sup>6</sup>Novystem Spa, Milan; <sup>7</sup>Department of Health Sciences, University of Milan, Milan; <sup>8</sup>Stem Cell Laboratory, Unit of Neurology, Fondazione IRCCS Ca' Granda Ospedale Maggiore Policlinico, University of Milan, Milan, Italy

**Introduction:** Multiple myeloma (MM) is a fatal malignant proliferation of antibody-secreting bone marrow plasma cells characterized by marked genomic instability. The discovery of lncRNAs has added a further layer of complexity to the pathobiology of the disease. NEAT1 is a highly expressed nuclear lncRNA, representing the core structural component of paraspeckle organelles. We previously demonstrated that NEAT1 silencing negatively regulates proliferation and viability of MM cells, both *in vitro* and *in vivo*, highlighting its pivotal role in DNA integrity maintenance, by regulating the homologous recombination. Despite the increasing information obtained by loss-of-function approaches, there is still a lack of information regarding possible oncogenic benefits acquired by MM cells upon NEAT1 overexpression. Here, we evaluated whether MM cells could gain survival advantages from the transactivation of NEAT1.

**Methods:** We adopted a CRISPR/Cas9 Synergistic Activation Mediator editing system to transactivate NEAT1 in the AMO-1 MM cell line. LNA-gapmer antisense oligonucleotide technology was used to silence NEAT1 in MM cells by gymnotic delivery. NEAT1 expression was assessed by qRT-PCR and NEAT1-specific RNA-FISH. Transcriptomic analysis was performed by RNA sequencing, following the TruSeq Stranded Total RNA protocol. Libraries with optimal quality and quantity were run on NextSeq 500. Cell cycle phases distribution and apoptotic rate were assessed by flow cytometry. Clonogenic potential was evaluated by the use of methylcellulose assay. Protein expression was investigated by WB and IF. Morphological images were obtained after May-Grunwald Giemsa staining.

**Results:** We performed a transcriptomic analysis of AMO-1 cells either transactivated or silenced for NEAT1. Our data revealed NEAT1 pivotal role in the maintenance of DNA integrity, showing a significant deregulation of almost all the crucial cellular DNA repair mechanisms for both single and double strand breaks. We highlighted a significant role played by NEAT1 transactivation in DNA repair mechanisms, through the activation of a molecular axis leading to the up regulation of two fundamental kinase proteins, *i.e.* ATM and DNA-PKcs, and the direct target pRPA32. Furthermore, our data strongly suggest an implication of NEAT1 in conferring oncogenic and pro-survival properties to MM cells exposed to nutrient starvation, hypoxia or chemotherapeutic treatment, suggesting that the specific targeting of NEAT1 could be of relevance for the identification of innovative MM strategy of treatment.

**Conclusion:** Overall, we provided novel important insights into NEAT1 role in DNA integrity maintenance in MM, demonstrating that NEAT1 deregulation strongly correlates with adaptation to stress condition and drug sensitivity of MM cells. Taken together, our results suggest that NEAT1 could represent Achilles' heel for MM cells and for this reason should be considered as a potential therapeutic target for MM treatment.

**C51****SMOLDERING MULTIPLE MYELOMA CLONAL AND TRANSCRIPTIONAL ARCHITECTURE CHARACTERIZATION AND ITS INTERACTION WITH MICROENVIRONMENT**

M.C. Da Vià<sup>1,2</sup>, M. Lionetti<sup>1,2</sup>, A. Maeda<sup>2</sup>, A. Marella<sup>2</sup>, A. Matera<sup>2</sup>, V. Bellani<sup>2</sup>, M. Bortolotti<sup>2</sup>, L. Pettine<sup>1</sup>, A. Pompa<sup>1</sup>, S. Fabris<sup>1,2</sup>, L. Baldini<sup>1,2</sup>, A. Neri<sup>1,2</sup>, N. Bolli<sup>1,2</sup>

<sup>1</sup>Hematology Unit, Fondazione IRCCS Ca' Granda Ospedale Maggiore Policlinico, Milan; <sup>2</sup>Department of Oncology and Hemato-Oncology, University of Milan, Milan, Italy

**Introduction:** Clonal heterogeneity is a biological hallmark of multiple myeloma (MM), already present in asymptomatic phases such as smoldering (S) MM. This heterogeneous composition of the tumor and its interplay with the immune microenvironment (IME) is postulated to represent the fuel for progression to symptomatic phases. To better understand biological determinants of progression of SMM and provide biomarkers for follow-up, here we performed a single-cell RNA-seq analysis on prospectively collected SMM patients' samples with clinical annotations.

**Methods:** We analyzed single cells derived from 11 consecutive SMM patients per IMW 2014 criteria. The CD138 positive and negative fractions were processed and analyzed separately. The bioinformatic analysis was conducted applying Seurat R package, the copykat tool for copy number variants and FUSCIA for translocations.

**Results:** Overall we analyzed 74.253 cells, of which 53.848 CD138pos and 20.405 CD138neg. The analysis of the tumor compartment highlighted the intra and inter-clonal heterogeneity of SMM. Concerning the former, we found an average of 4 clones per sample. We functionally explored each cluster, by defining its specific markers and conducting a gene-set enrichment analysis of differentially expressed genes. Interestingly, we found that the distinct clusters were characterized by the specific up-regulation of cellular pathways, and this was different from neighboring clusters likely reflecting a functional intra-tumoral biological heterogeneity. Moreover, based on the VDJ rearrangement analysis we could distinguish, within the same sample, the clonal plasma cells (PCs) from the polyclonal ones. As expected, they both shared the typical PC transcriptomic background, but, importantly, the application of copykat and FUSCIA identified the occurrence of MM-specific genomic lesions (*i.e.*, IGH translocations, hyperdiploidy and chromosomal amplifications or deletions, confirmed by FISH) only within pathological PCs, and their correlation with specific transcriptomic features such as CCND2, CCND1, NSD2 and c-MAF over-expression in cases with recurrent translocations. In addition, the tumor PCs were distinguished from the polyclonal counterpart for the expression of new markers of malignant PCs such as LAMP5 and FRZB1. In the IME, the T cell compartment was the most represented one, followed by monocytes. Inter-patient variability was notable for expression of T cell exhaustion markers and the rate of monocytes and M2-macrophages expressing immunosuppressive markers such as TIM3 and VISTA.

**Conclusions:** Our study dissected the heterogeneity in 11 SMM patients at the single cell level and highlighted the transcriptional differences between clonal PCs and their polyclonal counterparts. We linked the genomic and transcriptomic architecture to the IME composition. Further studies and longer follow up are needed to highlight clinical correlates.

**C52****PSMB4 AND PSMD4 PROTEASOMAL SUBUNITS CORRELATE WITH THE PRESENCE OF 1Q21 AMPLIFICATION IN CD138+ PLASMA CELLS: NEW POTENTIAL DRUGGABLE TARGETS IN MULTIPLE MYELOMA PATIENTS**

J. Burroughs-Garcia<sup>1,2</sup>, P. Storti<sup>1</sup>, L. Agnelli<sup>3</sup>, D. Toscani<sup>1</sup>, V. Marchica<sup>1</sup>, G. Sammarelli<sup>4</sup>, G. Todaro<sup>4</sup>, V. Raimondi<sup>1</sup>, V. Franceschi<sup>2</sup>, N. Soressi<sup>4</sup>, B. Dalla Palma<sup>4</sup>, L. Notarfranchi<sup>1</sup>, G. Donofrio<sup>2</sup>, N. Giuliani<sup>1,4</sup>

<sup>1</sup>Department of Medicine and Surgery, University of Parma, Parma; <sup>2</sup>Department of Medical-Veterinary Science, University of Parma, Parma; <sup>3</sup>Istituto Nazionale dei Tumori Foundation, Milan; <sup>4</sup>Hematology and BMT Unit, "Azienda Ospedaliero-Universitaria di Parma", Parma, Italy

**Introduction:** The amplification of the 1q21 (amp1q21) region is one of the most frequent acquired cytogenetic abnormalities (CA) in multiple myeloma (MM) associated with a worse patient outcome and in pre-malignant monoclonal gammopathies with disease progression. Moreover, different studies have demonstrated that the number of copies (CN) 1q21 (gain1q21: three copies or amp1q21:  $\geq$  four copies) have a different impact in the response to anti-MM therapies. Particularly, it has been proposed that in MM patients, additional copies of 1q21 may be associated with the resistance to the treatment with proteasome inhibitors (PIs). Here we aim to identify 1q21 target genes possibly correlated to the response to PI therapy.

**Methods:** We evaluated a total cohort of 29 patients with Smoldering MM (SMM) (n=11) and newly diagnosed MM (MMD) (n=18). Primary CD138+ plasma cells (PCs) were purified from bone marrow (BM) blood aspirates by immunomagnetic procedure. The transcriptional profiles of the BM PCs samples were generated on GeneChip ClariomD Arrays (Affymetrix Inc., Santa Clara, CA, USA). HMCLs were transfected with a control vector and PSMB4 and PSMD4 short hairpin RNA (shRNA) lentivectors. The gene and protein expression levels of PSMB4 and PSMD4 in human myeloma cell lines (HMCLs) were analyzed by qRT-PCR and Western Blot, respectively.

**Results:** Our bioinformatic analyses showed a significantly higher expression of two proteasome subunits (PSMB4 and PSMD4) in patients with 1q21 CN when compared with patients without (PSMB4  $p=0.0006$ ; PSMD4  $p<0.0001$ ). Patients with amp1q21 showed a higher expression of PSMB4 when compared to the patients with gain1q21 ( $p=0.007$ ). In our cohort, gene expression profile analysis also showed a strong positive correlation between gene expression levels and 1q21 CN for the proteasome subunits PSMB4 ( $p<0.0001$ ,  $r=0.5631$ ) and PSMD4 ( $p<0.0001$ ,  $r=0.6391$ ). Interestingly, we found that the PSMB4 and PSMD4 expression level was independent of the disease stage (SMM vs MMD) and was only driven by 1q21 CN. We have evaluated PSMB4 and PSMD4 mRNA and protein expression levels in a 1q21 wild-type cell line (OCY-MY5) and in a panel of HMCLs carrying different degrees of 1q21 CN. The mRNA expression level of PSMB4 and PSMD4 was higher in cell lines carrying 1q21 amp, following a 1q21 copy number fashion. Similar results were obtained when protein levels of HMCLs were analyzed by Western Blot. We generated a PSMB4-shRNA and PSMD4-shRNA knockdown stable MM cell lines. Functional studies showed that blockade of PSMB4 and PSMD4 decreased MM cell viability.

**Conclusion:** Our study identified proteasome subunits PSMB4 and PSMD4 to be significantly upregulated in MM patients carrying amp1q21, correlated with 1q21 copy number but not with disease stage. In addition, knockdown of both, PSMB4 and PSMD4 decreased MM cell proliferation. Therefore, targeting PSMB4 and PSMD4 could be a strategy to treat MM patients with amp1q21.

## C53

### SENSITIVITY TO BCMA-TARGETED IMMUNOTHERAPY IN BORTEZOMIB REFRACTORY MULTIPLE MYELOMA REQUIRES MITOCHONDRIAL INTEGRITY

E. La Spina<sup>1</sup>, C. Giallongo<sup>2</sup>, D. Tibullo, <sup>3</sup>A. Barbato<sup>1</sup>, G. Scandura<sup>1</sup>, I. Dulcamare<sup>1</sup>, D. Cambria<sup>1</sup>, L. Longhitano<sup>3</sup>, N.L. Parrinello<sup>4</sup>, A.G. Palumbo<sup>2,4</sup>, F. Di Raimondo<sup>1,2</sup>, A. Romano<sup>1</sup>

<sup>1</sup>Dipartimento di Chirurgia e Specialità Medico Chirurgiche, Università degli Studi di Catania; <sup>2</sup>Dipartimento di Scienze Mediche, Chirurgiche e Tecnologie avanzate; <sup>3</sup>Dipartimento di Scienze Biomediche e biotecnologiche; <sup>4</sup>U.O.C. Ematologia, A.O.U. Policlinico Rodolico San Marco, Italy

**Introduction:** Despite the therapeutic progress achieved for most patients, Multiple Myeloma (MM) remains a non-curable disease due to intrinsic or acquired drug resistance (DR). To date, new target antigens have been identified and BCMA (B-cell maturation antigen) shows promising results. Currently, the only anti-BCMA targeting therapy is the antibody-drug conjugate Belantamab-mafodotin (BeMa), recently approved for use in Proteasome Inhibitor (PI) Relapsed/refractory (R/R) MM patients. Aim: to address off-target effects of BeMa in human MM

cell lines (HMCLs) and in primary plasma cells from 15 newly diagnosed (ND) or R/R MM patients. **Methods:** effects of BeMa in both HMCLs and ND or R/R MM patients were evaluated combining in vitro assays, western blot analysis and gene expression profile. **Results:** Firstly, we evaluated surface expression of BCMA on HMCLs. No significant differences were observed among all tested HMCLs. Despite this, U266 cells showed a significant increase of apoptosis in a dose-dependent manner after BeMa treatment, while OPM2 do not respond even at higher drug doses. In addition, BeMa was able to induce a G2/M cell cycle arrest only in U266 cell line. Since our previous data highlighted that refractoriness to the most common PI is often associated to mitochondrial dysfunction, increased autophagy and fatty acids metabolism, we next evaluated these mechanisms after BeMa treatment. Interestingly, BeMa increased mitochondrial ROS amount in U266 and impaired mitochondrial fitness as demonstrated by the increase of mitochondrial membrane depolarization and expression of PINK-1, a protein associated to mitochondrial dysfunction. On the contrary, OPM2 showed increased mitochondrial mass after BeMa exposure without increase in mitochondrial ROS and PINK-1 expression. Using qRT-PCR we confirmed PCG1- $\alpha$ , TFAM and ND4 upregulation only in OPM2 but not in U266, suggesting that mitochondrial biogenesis and the increase of OXPHOS genes in OPM2 could be considered as a responsive mechanism to BeMa-induced stress leading to DR. In addition, mRNA levels of NAD<sup>+</sup> synthetic enzymes, including NAMPT, NMNAT-1, NMNAT-2, and NMNAT-3, were overexpressed in OPM2 after BeMa. Also in primary PCs, the higher levels of apoptosis after BeMa were observed in CD138+ cells with higher BeMa-induced mitochondrial depolarization. Since oxidative mitochondrial metabolism is strongly associated with fatty acids metabolism, lipid droplets were quantified in HMCLs after BeMa exposure by oil red O staining. We observed cytoplasmatic lipids decrease only in OPM2, associated to upregulation of p62 protein which regulates intracellular lipid storage (macrolipophagy). **Conclusions:** taken together, our data suggest a role of metabolic reprogramming through increased fatty acid consumption rate and OXPHOS metabolism in reducing anti-BCMA targeting therapy efficacy, opening a new scenario about the molecular pathway underlying BeMa resistance.

## C54

### DEPLETION OF DIS3 IN MULTIPLE MYELOMA CAUSES EXTENSIVE PERTURBATION IN RNA METABOLISM, CELL CYCLE PROGRESSION AND MITOTIC CHECKPOINT: IMPLICATIONS FOR THE PATHOGENETIC ROLE IN THE DISEASE

V.K. Favasuli<sup>1,2</sup>, I. Silvestris<sup>1,2</sup>, K. Todoerti<sup>1</sup>, D. Ronchetti<sup>1,2</sup>, S. Erratico<sup>3</sup>, D. Giannandrea<sup>4</sup>, Y. Torrente<sup>5</sup>, R. Chiaramonte<sup>4</sup>, S. Fabris<sup>2</sup>, L. Baldini<sup>1,2</sup>, A. Neri<sup>1,2</sup>, E. Taiana<sup>1,2</sup>

<sup>1</sup>Department of Oncology and Hemato-Oncology, University of Milano; <sup>2</sup>Hematology Unit, Fondazione IRCCS Ca'Granda, Ospedale Maggiore Policlinico, Milan; <sup>3</sup>Novosystem Spa, Milan; <sup>4</sup>Department of Health Sciences, Università degli Studi di Milano, Milano; <sup>5</sup>Stem Cell Laboratory, Unit of Neurology, Fondazione IRCCS Ca'Granda Ospedale Maggiore Policlinico, Università degli Studi di Milano, Milan, Italy

**Introduction:** MM is a genetically heterogeneous neoplasm in which the co-occurrence of multiple genomic events play a crucial role in tumor development, progression and drug resistance. DIS3 gene maps at 13q22 and encodes for a highly conserved ribonuclease involved in the RNA processing, quality control and degradation. Deletion of DIS3 gene is a common characteristic of MM patients (approximately 50% of cases); moreover, DIS3 mutations occur in about 11% of MM cases and are frequently (70%) associated with loss of the gene. DIS3 mutations along with del(13q) have been recently described by us as associated with a strong negative effect on clinical outcome.

**Methods:** LNA gapmeRs were used to silence DIS3 in HMCLs by gymnotic delivery in four human myeloma cell lines, two of which showing a monoallelic del(13q). qRT-PCR has been used to evaluate DIS3 silencing efficiency. Cell viability and cellular growth was evaluated by viable counts and by Cell Titer Glo assay. Modulation of cell cycle phases distribution was assessed by flow cytometry. 7-AAD/Annexin flow

cytometry analysis was used to evaluate apoptotic cell death. Cell cycle synchronization was obtained using SynchroSet kit. Transcriptional analysis was performed using Affymetrix microarray. Protein expression was evaluated by Western Blot. Mitotic spindle organization was analyzed by immunofluorescence (IF).

**Results:** DIS3 silenced HMCLs show a significant decrease of cellular growth right after 4 days from LNA gapmeR delivery. DIS3 depleted cells showed a significant increase in the percentage of cells in G0/G1 phase and a decrease of S and G2/M phases in all the HMCLs tested. Analysis of synchronized HMCLs revealed a more pronounced modulation of all cell cycle phases distribution confirming the involvement of DIS3 in cell cycle regulation. Accordingly, DIS3 silencing associates with the downregulation of crucial proteins for cell cycle and mitotic spindle checkpoints. Confocal microscopy analysis performed in DIS3 silenced HMCLs revealed the presence of mitotic defects, microtubule organization abnormalities. Transcriptional profile analysis of DIS3-KD samples revealed a strong modulation of cell cycle regulation and mitotic spindle related pathways, together with the expected, strong modulation of RNA degradation pathway.

**Conclusions:** Our data indicate that DIS3 silencing in HMCLs leads to a cell cycle perturbation accompanied to an increase of mitotic defects. To the best of our knowledge, this is the first evidence in the context of the pathological role of DIS3 in MM. These results should be considered of interest considering that DIS3 abnormalities are a common feature of MM patients. Moreover, the transcriptional analyses may contribute to identify putative DIS3-related pathways and genes (with coding or non-coding potential) involved in tumorigenic mechanisms in MM and possibly implicated in the therapeutic settings.

## C55

### CLONAL HEMATOPOIESIS (CH) IS A NEW PROGNOSTIC FACTOR FOR MM PATIENTS: FOCUS ON CARDIOVASCULAR TOXICITY

E. Gelli<sup>1</sup>, C. Martinuzzi<sup>1</sup>, D. Soncini<sup>1</sup>, P. Becherini<sup>2</sup>, A. Cagnetta<sup>2</sup>, R.M. Lemoli<sup>1,2</sup>, M. Cea<sup>1,2</sup>

<sup>1</sup> *Clinic of Hematology, Department of Internal Medicine (DiMI), University of Genoa;* <sup>2</sup> *IRCCS Ospedale Policlinico San Martino, Clinic of Haematology, Italy*

**Background:** Recent studies have identified, in the blood of ageing people, the presence of somatic mutations in hematopoietic cells, a condition referred as clonal hematopoiesis of unknown significance (CHIP). CHIP is associated with a 0.5–1% risk of progression to a non-plasma-cell hematologic neoplasm, in particular myelodysplastic syndrome (MDS) and acute myeloid leukemia (AML). In cancers, the prevalence of CHIP is higher compared to healthy population, especially for ones who have been exposed to cytotoxic chemotherapy or radiation. The presence of CHIP clones has been documented in multiple myeloma (MM) too, and, in patients receiving autologous transplantation, it has been associated with a worse prognosis. Moreover, clonal hematopoiesis represents an age-related risk factor for cardiovascular disease-related morbidity and mortality as well. Here we have evaluated the prognostic significance of CHIP in newly diagnosed (ND) MM patients by focusing on its relationship with cardiovascular events, to better define the risk assessment of these patients.

**Methods:** Deep targeted sequencing of peripheral blood from 50 NDMM patients was analyzed by NGS sequencing using a panel of 36 CHIP-related genes. The detected somatic mutations as well as their variant allele frequency (VAF) were correlated with demographic and clinical parameters, including age, sex, R-ISS stage, outcomes, and occurrence of cardiovascular events.

**Results:** Somatic mutations were detected in ~30% of analyzed MM patients with a VAF between 2.10% and 38.6%. Such higher prevalence compared with previously reported data (~30% vs ~5%), is probably due to the higher sensitivity of used sequencing technique as well as the higher age of MM collected samples. The most frequently mutated gene was TET2 followed by DNMT3A. Greater occurrence was observed among high-risk (R-ISS 3) patients and in those with bone disease, regardless of age. Indeed, we didn't observe a correlation between CHIP occurrence and age, but a positive relationship between VAF and age was found,

particularly among high-risk patients (R-ISS stage 2 and 3). Regarding cardiovascular events, higher prevalence of CHIP was observed in patients with high blood pressure and in those with prior atherosclerotic cardiovascular conditions.

**Conclusions:** Although a larger cohort is needed to support our data, we suggest CHIP as novel prognostic factor in MM, and support its evaluation especially in patients who undergo potentially cardiotoxic agents, for a more accurate clinical management and prevention of adverse events in CHIP carriers.

## C56

### DYSREGULATED MITOCHONDRIAL DYNAMICS UNDERLIES BORTEZOMIB RESISTANCE IN MULTIPLE MYELOMA

M.E. Gallo Cantafio<sup>1</sup>, I. Perrotta<sup>2</sup>, R. Torcasio<sup>1,3</sup>, D. Tibullo<sup>4</sup>, F. Di Raimondo<sup>4</sup>, M. Gentile<sup>5</sup>, G. Viglietto<sup>1</sup>, A. Neri<sup>6</sup>, N. Amodio<sup>1</sup>

<sup>1</sup> *Dipartimento di Medicina Sperimentale e Clinica, Università Magna Graecia;* <sup>2</sup> *Centro di Microscopia e Microanalisi, Laboratorio TEM, Dipartimento di Biologia e Scienze della Terra, Università della Calabria;* <sup>3</sup> *Dipartimento di Biologia, Ecologia e Scienze della Terra, Università della Calabria;* <sup>4</sup> *Dipartimento di Scienze Biomediche e Biotecnologiche, Università di Catania;* <sup>5</sup> *U.O di Ematologia, Ospedale "Annunziata";* <sup>6</sup> *Dipartimento di Oncologia ed Emato-oncologia, Italy*

**Introduction:** The reliance of multiple myeloma (MM) cells on the proteasome degradation system has provided the rationale for the wide clinical use of proteasome inhibitors (PI). However, the complex biology of MM cells inevitably triggers PI resistance, often associated with dysfunctional mitochondrial networks. Changes in mitochondrial dynamics, consisting in a continuum between fission and fusion, impact on various tumor phenotypes, but their role in MM pathobiology remains undisclosed. Herein, we have analyzed the biological significance of mitochondrial dynamics using models of drug-resistant MM.

**Methods:** Mitochondrial structure was assessed by transmission electron microscopy (TEM) analysis of paired isogenic cell lines. Mitochondrial dynamics regulators' expression was evaluated by qRT-PCR and western blotting (WB). Cell viability was assessed by CTG or CCK8 assays, while apoptosis by Annexin V/7-AAD. ROS and mitochondrial superoxide species were determined by H2DCFDA and MITOSOX red staining. Daratumumab-dependent ADCC was assessed by FACS analysis of Far Red-labeled MM cells co-cultured with PBMCs (effector-to-target ratio of 25:1).

**Results:** TEM analysis evidenced peculiar mitochondrial patterns, with elongated and likely dividing mitochondria detectable in bortezomib (BZ)-resistant, but not in dexamethasone (DEXA)-resistant MM cells with respect to parental counterparts. This finding prompted us to investigate the role of mitochondrial dynamics in the onset of PI resistance. Specifically, we observed the upregulation of mitochondrial fission drivers, namely the GTPase Drp1, its active S616 phosphorylated form, the Drp1-receptor MFF, and the cristae regulator OPA1 and the down-regulation of fusion promoter MFN2, in three different BZ-resistant as well as carfilzomib-resistant, but not in DEXA-resistant, paired isogenic MM cell lines. These data indicate a push towards mitochondrial fission during PI resistance acquisition. Moreover, BZ treatment promoted Drp1, MFF and OPA1 down-regulation in PI-sensitive cells, while their expression remained elevated in the resistant ones. Targeting mitochondrial dynamics with mDIVI-1, an established fission inhibitor, reduced the viability of MM cells, even co-cultured with patient-derived bone marrow stromal cells, increased ROS and mitochondrial superoxide species and enhanced bortezomib activity, without being cytotoxic to healthy PBMCs; conversely mitochondrial fission enhancement through MFF overexpression antagonized bortezomib activity. Finally, we provide preliminary evidence of mitochondrial dynamics impact on the antigenic repertoire of MM cells: in fact, while the MFF overexpression down-regulated CD38, mDIVI-1 triggered its expression thus enhancing daratumumab-elicited ADCC.

**Conclusion:** These findings implicate unbalanced mitochondrial dynamics at the onset of BZ resistance, highlighting potential targets for (immune)therapeutic interventions applicable to the MM relapse and refractory setting.

## Acute Leukemias 2

C57

### INVESTIGATING THE INTERPLAY OF CD99 AND FLT3-ITD: NOVEL INSIGHTS INTO AML RESISTANCE

S. Travaglini<sup>1</sup>, T. Ottone<sup>1-2</sup>, D.F. Angelini<sup>2</sup>, V. Fiori<sup>3</sup>, S. Dominici<sup>3</sup>, N.I. Noguera<sup>1-2</sup>, M. Sniegocka<sup>4</sup>, S. Antonelli<sup>1</sup>, M.I. Consalvo<sup>1</sup>, De Bardi Marco<sup>2</sup>, C. Banella<sup>2</sup>, M. Divona<sup>1</sup>, F. Marchesi<sup>5</sup>, S. Masciarelli<sup>4</sup>, F. Fazi<sup>4</sup>, M. Pieraccioli<sup>6</sup>, R. Palmieri<sup>1</sup>, G. De Angelis<sup>1</sup>, F. Buccisano<sup>1</sup>, A. Venditti<sup>1</sup>, L. Battistini<sup>2</sup>, M. Magnani<sup>3</sup>, M.T. Voso<sup>1-2</sup>

<sup>1</sup>Department of Biomedicine and Prevention, University of Tor Vergata, Rome; <sup>2</sup>Santa Lucia Foundation, I.R.C.C.S., Neuro-Oncohematology, Rome; <sup>3</sup>Diatheva srl, 61030, (PU); <sup>4</sup>Department of Anatomy, Histology, Forensic Medicine and Orthopedic, Section of Histology, Sapienza University of Rome, Rome; <sup>5</sup>Hematology and Stem Cell Transplant Unit, IRCCS Regina Elena National Cancer Institute, Rome; <sup>6</sup>Department of Neuroscience, Section of Human Anatomy, Catholic University of the Sacred Heart, Rome, Italy

Acute myeloid leukemia (AML) with FLT3-ITDmut remains a therapeutic challenge, with a still high relapse rate, partly due to the persistence of LSCs. In this disease, the CD34/CD123/CD25/CD99<sup>+</sup> leukemic precursor cells (LPCs) phenotype predicts for FLT3-ITDmut and disease recurrence. Particularly, these cells are characterized by the overexpression of CD99, making this cell subpopulation sensitive to an anti-CD99mAb. Indeed, CD99 represents a LSCs-specific marker involved in disease aggressiveness, cell mobilization and trafficking, suggesting its involvement in processes of metastasis formation and immune escape. Based on our previous evidences indicating a correlation between CD99 expression and the presence of FLT3-ITDmut, we hypothesize that investigating the role of the CD99 surface glycoprotein and the interaction with FLT3-ITD may allow to identify a new therapeutic target involved in treatment resistance.

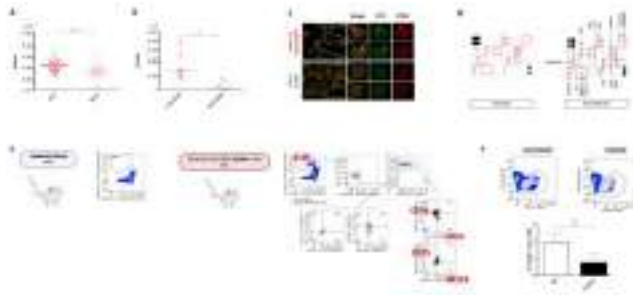

**Figure 1.** A. Mean fluorescence intensity (MFI) of CD99 antigen on paired LPCs and primary blasts purified from FLT3-ITDmut AML patients by high-speed sorting at diagnosis (n=27)(p<0.0001). B. CD99-MFI on paired CD99<sup>+</sup>/CD38<sup>-</sup> and CD99<sup>+</sup>/CD38<sup>+</sup> LPCs (p=0.015); C. FLT3 and CD99 co-localizes in the perinuclear region in FLT3-ITDmut MV4-11 cells, interaction not observed in FLT3<sup>wt</sup> THP1 cells. D. CD99 engagement by the anti-CD99 mAb induces intrinsic and extrinsic apoptosis pathway in FLT3-ITDmut MV4-11 cells. E. Representative flow cytometry analyses of human engraftment of CD34<sup>+</sup>/CD99<sup>+</sup> LPC and leukemia bulk cells transplanted in NSG mice; F. Anti-CD99 mAb treatment affects homing and engraftment of leukemic cells MOLM-13 in transplanted NSG mice. P values were calculated by a paired Student's t-test. MFI: mean fluorescent intensity; AR: allelic ratio; LPCs: CD34/CD123/CD25/CD99<sup>+</sup> leukemic precursor cells, AML: acute myeloid leukemia.

Bone marrow (BM) samples (n=27) from FLT3-ITDmut AMLs were analysed for CD99 expression by flow cytometry and sorted to isolate CD34/CD123/CD99/CD25<sup>+</sup>LPCs. Whole transcriptome RNA sequencing was performed on CD99<sup>+</sup>/CD38<sup>-/+</sup> LPC and leukemia bulk paired samples purified from 10 FLT3-ITDmut AMLs. CD99 and FLT3 localization, was analysed by immunofluorescence. Sensitivity to the anti-CD99mAb (Diatheva, PU, Italy) was assessed on AML cell lines and

primary blasts (n=17) by cell proliferation, apoptosis and metabolism. NSG mice were transplanted with the FLT3-ITDmut cell line MOLM-13, high-speed sorted LPCs and unfractionated bulk leukemic blasts. A higher CD99-mean fluorescence intensity was observed on LPCs as compared to paired blasts (Figure 1A), particularly in the LSC-enriched CD34<sup>+</sup>/CD38<sup>-</sup> fraction, corroborating its association to LSC activity. Indeed, RNAseq of the LPCs revealed a high expression of markers associated with disease aggressiveness and poor survival in AML, such as CD200. Furthermore, we found a positive correlation between CD99 expression and FLT3-ITDmut load (Figure 1B). In an attempt to elucidate this correlation, we observed a co-localization of FLT3 and CD99 in the perinuclear region, only in FLT3-ITDmut MV4-11 cells (Figure 1C). Interestingly, the anti-CD99mAb treatment was able to selectively induce apoptosis in FLT3-ITDmut cells through both the intrinsic and extrinsic pathway, probably induced by p53 activation (Figure 1D), confirming the lack of sensitivity observed in p53mutsamples. To test whether CD99 enriches for LSC function, we transplanted paired CD99<sup>+</sup>/CD99<sup>-</sup> LPCs and blasts (n=18) into NSG mice, and we observed an early engraftment, only in LPC-transplanted mice after 12 weeks. Additionally, blocking CD99 with the anti-CD99mAb treatment(100 µg/day) for 7 days, inhibited homing and repopulation in mice transplanted with FLT3-ITDmut MOLM-13. In summary, our study provide new insights into the role of CD99 as a novel marker of FLT3-ITDmut AMLs and a promising therapeutic target involved in disease progression and resistance.

C58

### WHOLE TRANSCRIPTOME RNA-SEQ ANALYSIS IN EXTRAMEDULLARY ACUTE MYELOID LEUKEMIA REVEALED A DYSREGULATION OF CRITICAL PATHWAYS LINKED TO TUMORIGENESIS AND METASTASIS

T. Ottone<sup>1-2</sup>, A.M. Nardoza<sup>1</sup>, G. Silvestrini<sup>1</sup>, F. Marchesi<sup>3</sup>, A. Mauriello<sup>4</sup>, R.G. Piazza<sup>5</sup>, S. Travaglini<sup>1</sup>, A. Pirola<sup>6</sup>, M. Divona<sup>1</sup>, M. Marino<sup>7</sup>, P. Ricci<sup>1</sup>, E. De Bellis<sup>8-9</sup>, R. Palmieri<sup>1</sup>, M.I. Del Principe<sup>1</sup>, A. Venditti<sup>1</sup>, M.T. Voso<sup>1-2</sup>

<sup>1</sup>Department of Biomedicine and Prevention, University of Tor Vergata, Rome; <sup>2</sup>Santa Lucia Foundation, I.R.C.C.S., Neuro-Oncohematology, Rome; <sup>3</sup>Hematology and Stem Cell Transplant Unit, IRCCS Regina Elena National Cancer Institute, Rome; <sup>4</sup>Department of Experimental Medicine, University of Rome Tor Vergata, Rome; <sup>5</sup>Department of Medicine and Surgery, University of Milano - Bicocca, Monza (MB); <sup>6</sup>GalSeq s.r.l., Bresso (MI); <sup>7</sup>Department of Pathology, IRCCS Regina Elena National Cancer Institute, Rome; <sup>8</sup>Department of Biomedicine and Prevention, PhD in Immunology, Molecular Medicine and Applied Biotechnology, University of Rome Tor Vergata, Rome; <sup>9</sup>SC Ematologia, Azienda Sanitaria Universitaria Giuliano Isontina Trieste, Italy

Extramedullary acute myeloid leukemia (EM-AML) is a rare form of AML, associated with poor prognosis and shorter survival. Leukemic sarcomas are aggressive and typically resistant to drugs designed to treat AML. Unlike in solid tumors, knowledge of the metastatic behaviour of blasts is scarce, and the genetic mechanisms of EM-tissue-invasion have not been well characterized. To elucidate the molecular mechanisms underlying EM leukemia, we analyzed by a high-throughput genetic approach, the whole transcriptome architecture of BM and EM localizations from AML patients. BM samples from 4 AMLs and 2 APLs, and the respective EM localizations, were studied. Clinical and biological characteristics are shown in Table 1. Libraries were sequenced on an Illumina-platform with paired-end reads 150bp long, at a depth of 27 million cluster/sample. Differential expression was studied out using DESeq2. Genes with |log<sub>2</sub> fold change|>2 and adjusted p-value (Benjamini-Hochberg-False-Discovery-Rate-FDR) <0.1 were considered as differentially expressed. The enrichment analysis was performed using the bioinformatics tool DAVID-v6.8 to visualize the KEGG pathways. In addition, we used the Gene Set Enrichment Analysis (GSEA) tools v4.1.0 for the identification of specific signatures with a pre-ranked algorithm, and the Molecular Signatures Database (MSigDB) to annotate gene sets. The Volcano plot (Figure 1A) displayed the differential expression of 43190 genes in BM as compared to EM-tumors. After comprehensive analysis and screening using the Venn-diagram-tool, the intersection of DAVID and GSEA datasets showed

the 4 common altered KEGG-pathways. In particular, 2 of them, mainly involved in cancer progression (ECM-receptor-interaction and focal-adhesion signal transduction), were the most significantly enriched. In addition, further enrichment analysis revealed 2 additional pathways which play a critical role in migration and invasion of metastatic cells (PI3K-Akt signaling from DAVID and epithelial-mesenchymal transition from GSEA). Remarkably, DAVID and GSEA output identified the same 24 common differentially expressed genes (Figure 1B). In particular, the GSEA analysis performed on RNA-Seq data, exhibited an enrichment of many signatures, 5 of which were significantly overexpressed in BM and 11 downregulated in the EM localization, according to enrichment score and FDR. Moreover, we showed upregulation of the 3 previously reported pathways contributing to tumor evolution in BM cases with solid EM. On the contrary, AML with cerebrospinal fluid (CSF) involvement displayed downregulation of genes related to cell-cycle progression.

Table 1. Clinical and biological characteristics of 6 myeloid leukemia patients.

ID	Sex	Age	Myeloid Involvement	Diagnosis	Relapse	Molecular alterations	Pre-treatment	BM Status (MT)	CSF Status (EM)
L1918	F	35	AML			FML/RAS	115.17	12	Cerebrospinal fluid
L1919	F	52	AML			FML/RAS	115.17	+8	Lymph node
L1915	F	46	de novo AML			FLT3/ITD and NPM1	normal	93	Cerebrospinal fluid
L1914	M	66	de novo AML			/	normal	+8	Bone marrow
L1916	M	71	de novo AML			NPM1	DEL(11)(p15.5)(q24)	98	Lymph node
L1917	F	36	de novo AML			FLT3-ITD	DM12	41	Colorectal tissue

C59

ROLE OF PLZF-RAR IN THE METABOLISM OF ACUTE MYELOID LEUKEMIA

A. Zaza<sup>1,2</sup>, G. Catalano<sup>1,2</sup>, S. Travaglini<sup>1,2</sup>, E. Fabiani<sup>1</sup>, M. Divona<sup>3</sup>, T. Ottone<sup>1,2</sup>, M.T. Voso<sup>1,2</sup>, N.I. Noguera<sup>1,2</sup>

<sup>1</sup>Department of Biomedicine and Prevention; University of Rome Tor Vergata; <sup>2</sup>I.R.C.C.S Santa Lucia Foundation; <sup>3</sup>Policlinico di Tor Vergata, Italy

**Background:** PLZF-RARα (ZBTB16-RAR α) fusion protein binds retinoic acid response elements (RARE) to repress transcription of genes essential for myeloid maturation and differentiation, driving a rare APL variant (2% of APLs). Such APL variant is not sensitive to retinoic and arsenic treatment.

**Aims:** We studied PLZF-RARα bearing cells' metabolism in order to define possible targets for tailored therapeutic strategies. In particular, we focused on its interference with Nrf2 protein, transcription factor central in the adaptive cellular response to stress. **Methods:** We used a PLZF-RARα inducible cellular system: U937-B412 cells (B412) containing a ZnSO4 inducible PLZF-RARα construct, and control U937-MT (MT) cells to define hybrid protein induced metabolism peculiarities via Seahorse Bioscience XF96 analysis. We defined Nrf2 function by Q-RT-PCR and Western blot analysis, co-immunoprecipitation techniques and immunofluorescence to study Nrf2 and its transcriptional targets.

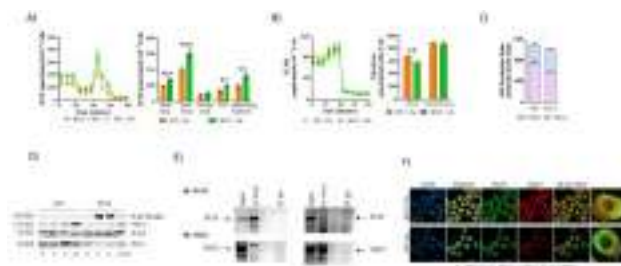

Figure 1. (A) Western blot analysis of NRF2 and HO-1 in MT (control) and B412 (PLZF-RARα positive) cells lines after treatment with Zn. (B) Histograms represent basal respiration, maximal respiration and spare respiratory capacity measured using the XF Myto Stress Test assay. (C) Glycolytic function, basal glycolysis and glycolytic compensatory measured using the XF Glycolytic Rate Assay. (D) Profile of the glycolytic and mitochondrial ATP production using the XF ATP rate assay. (E) Total lysates fractions of B412 cells were IP with anti PLZF and anti NRF2 and analyzed with antibodies anti PLZF and anti NRF2. (F) Microscopy analysis of PLZF and NRF2 localization in MT (control) and B412 (PLZF-RARα positive) cells treated with ZnSO4 100 μM for 3 hours.

**Results:** PLZF-RARα expression is maximal at 3hrs after ZnSO4 induction and persist up to 24 hours later. It induces: (i) mitochondrial respiration enhancement [basal oxidative phosphorylation (OXPHOS) (MT: 95±6 B412: 135±14 (pmol/min)/6x10<sup>4</sup> cells, p<0.0001), respiratory reserve (MT: 93±41 B412: 155±55 (pmol/min)/6x10<sup>4</sup> cells, p=0.01) and ATP production (MT: 65±20 vs B412: 96±23 (pmol/min)/6x10<sup>4</sup> cells, p=0.008)] (Figure 1A); (ii) glycolysis reduction (MT: 93±41 B412: 155±55 (pmol/min)/6x10<sup>4</sup> cells, p=0.01). Those results were confirmed by enhanced mitochondrial ATP production and reduction of glycolytic ATP (XF Real-Time ATP Rate Assay); (iii) enhanced substrate flexibility (pyruvate, glutamine and fat acids) (Figure 1C). We noticed that PLZF-RARα induction reduces significantly NRF2 protein and target genes HO-1 e NQO1 expression, but not Nrf2 mRNA level (Figure 1D). Indicating a post-translational interference. We demonstrate that PLZF-RARα physically interacts with Nrf2 by co-immunoprecipitation, confirmed by co-localization at immunofluorescence analysis by confocal microscopy (Figure 1E).

**Summary/Conclusion:** Metabolic reprogramming is the hallmark of cancer, our results indicate that PLZF-RARα regulates cellular metabolism inducing flexibility and resistance to therapy; it interact physically with NRF2 protein.

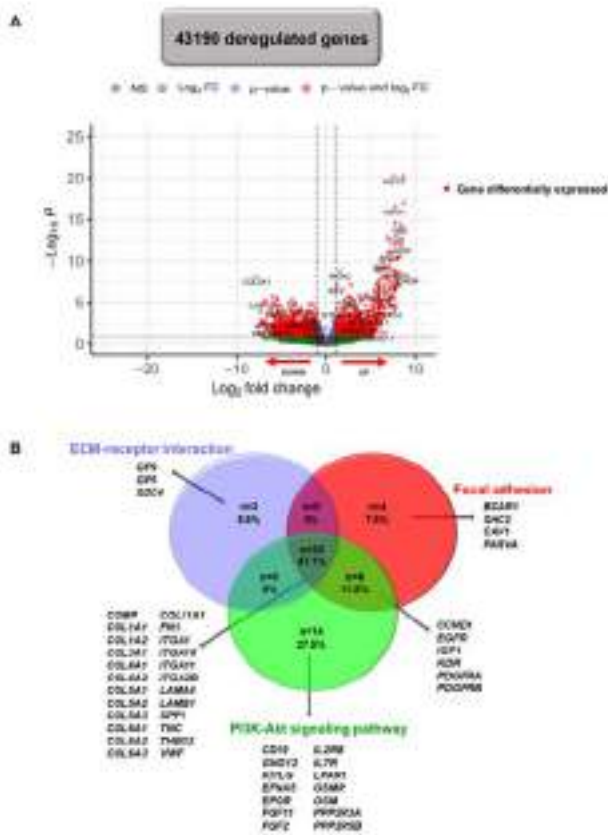

Figure 1.

Our enrichment analysis of gene expression profiling in EM-leukemia suggest an involvement of processes closely associated with neoplastic cell invasion. This study might allow to identify new predictive markers of disease progression.

## C60

## ISOCITRATE DEHYDROGENASES AML-ASSOCIATED POINT MUTATIONS DRIVE A BLOCK OF DIFFERENTIATION IN HUMAN NORMAL CD34+ HEMATOPOIETIC CELLS THAT IS RELEASED BY SPECIFIC INHIBITORS

S. Pierangeli\*, V. Ciaurro\*, S. Donnini, F. Milano, M. Sabino, I. Gionfriddo, R. Ranieri, S. Silvestri, V. Tini, G. Spinozzi, B. Falini, M.P. Martelli (\*These authors contributed equally)

Dipartimento di Medicina e Chirurgia, Sezione di Ematologia ed Immunologia Clinica, Università degli Studi di Perugia, Italy

**Introduction:** Acute myeloid leukemia (AML) arises from multiple and sequential genetic alterations in hematopoietic precursors. Mutations of isocitrate dehydrogenases IDH1/2 are found in about 20 % of AML: IDH1-R132H and IDH2-R140Q or R172K are the most represented. The direct effects of IDH AML-associated mutations on human hematopoietic stem cell fate decision and the interference of the specific inhibitors AG-120 for IDH1 and AG-221 for IDH2 are poorly studied. Our previous data (presented at XVI°SIES) shown that expression of IDH1-R132H transgene in human CD34+ cells induced a block of differentiation that was released by treatment with AG-120. To strengthen our data we have increased the experimental set for IDH1 and we used the same approach to unravel how IDH2-R140Q mutation affects differentiation of human CD34+ cells. We also investigated *in vivo*, over time, the effect of IDH2 inhibition on the fitness to form colonies of the CD34+ cells isolated from the bone marrow of one AML patient carrying the IDH2-R140Q mutation and treated with the IDH2-inhibitor enasidenib.

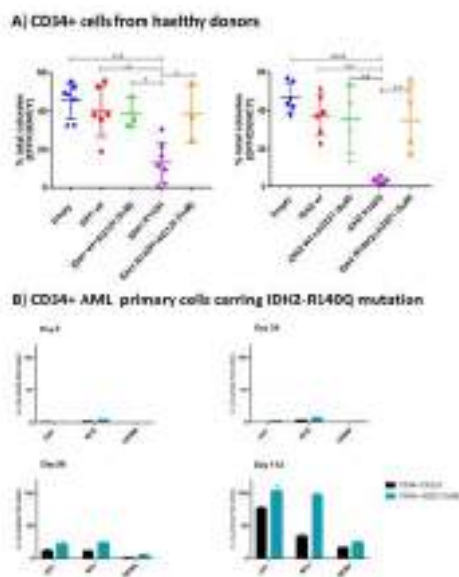

**Figure 1.** A) CD34+ cells from healthy donors. Percentage of CFU after 14 days in methylcellulose culture, with or without the specific inhibitor, arising from CD34+ cells infected with IDH1 transgenes (empty, wt or R132H) [graphs on the left] and from CD34+ infected with IDH2 transgenes (empty, wt or R140Q) [graphs on the right]. B) CD34+ AML primary cells carrying IDH2-R140Q mutation. Number of CFU arising after 14 days in methylcellulose culture, in presence or absence of IDH2-inhibitor enasidenib, *ex vivo*, over time; colonies belonging to erythrocytes (ERY), granulocytes/monocytes (MYE) and multilineage (GEMM) precursors are shown.

**Methods:** CD34+ cells of healthy donors (hCD34+) were infected by lentiviral vectors containing the ZsGreen gene reporter and the genes of interest: IDH1 wild-type (wt) or R132H (n=4+3 new donors) and IDH2 wt or IDH2-R140Q (n=6). After 72h, ZsGreen-positive cells were sorted, counted and used for colony-forming unit (CFU) methylcellulose differentiation assays, in presence or absence of inhibitor: AG-120 5uM (n=3) or AG-221 5uM (n=4). After 14 days, colonies were analyzed by STEMvision instrument. Similarly, primary IDH2-mutated cells were sorted for CD34 positivity and evaluated by CFU assay, with or without inhibitor, at different time points of treatment.

**Results:** New data available for IDH1 confirmed that R132H muta-

tion blocks cloning efficiency in hCD34+ which can be reverted by AG-120. Interestingly, even more markedly a block of differentiation - across all lineages - was induced by IDH2-R140Q mutation when compared with empty vector (p<0,0001\*\*\*\*) or with wt (p=0,0004\*\*\*) and was completely released by AG-221 (p=0.0028\*\*). Interestingly, in the patient, we observed that treatment with enasidenib induced a progressive improvement of the CFU ability of the CD34+ cells, in keeping with the recorded hematological recovery. Transcriptomic changes in hCD34+ expressing IDH1 and IDH2 oncogenes have been studied by RNAseq. Analyses are ongoing and data will be presented at the national meeting.

**Conclusions:** Expression of mutant IDH1 and IDH2 in CD34+ human cells and in primary AML cells is sufficient to induce a block of hematopoietic differentiation that can be reverted by specific inhibitors treatment. These preliminary data in human cell models will allow to explore the specific pathways involved in IDH-mutants leukemogenesis and in inhibitors response.

## C61

ABSTRACT WITHDRAWN

## C62

## WHOLE EXOME SEQUENCING OF BONE MARROW MESENCHYMAL STEM CELLS ISOLATED FROM PATIENTS WITH THERAPY-RELATED MYELOID NEOPLASM

G. Falconi<sup>1</sup>, E. Gatti<sup>2,3</sup>, E. Galossi<sup>1</sup>, C. Ronchini<sup>4</sup>, E. Fabiani<sup>1</sup>, A. Pirola<sup>5</sup>, R. Piazza<sup>6</sup>, P.G. Pelicci<sup>2,7</sup>, M.T. Voso<sup>1</sup>

<sup>1</sup>Department of Biomedicine and Prevention, Tor Vergata University; <sup>2</sup>Department of Experimental Oncology, European Institute of Oncology IRCCS; <sup>3</sup>Unit of Histopathology and Molecular Diagnostics, European Institute of Oncology IRCCS; <sup>4</sup>Clinical Genomics, European Institute of Oncology IRCCS; <sup>5</sup>GalSeq s.r.l.; <sup>6</sup>Dept. of Medicine and Surgery, University of Milano - Bicocca; <sup>7</sup>Department of Oncology and Hemato-Oncology, University of Milan, Italy

**Introduction:** The bone marrow (BM) microenvironment is known to be involved in the pathophysiology of de novo myeloid neoplasms (MN), and mesenchymal stem cells (MSCs) are pivotal components. In recent years, several groups have attempted to elucidate the genetic profile of de novo MN-MSCs but the results were not entirely conclusive often due to the lack of germinal controls. Moreover, to our knowledge, little is known on the spectrum of somatic mutations of MSCs isolated from therapy-related myeloid neoplasm (t-MN), including diseases arising in patients treated with chemo- and/or radiotherapy for a previous tumor or autoimmune disease. DNA damage, a direct consequence of the activity of many anticancer drugs, can determine permanent modifications in BM hematopoietic stem cells. However, it is not known whether chemotherapy-induced mutagenesis also targets BM-MSC.

**Methods:** We tested by Whole Exome Sequencing (WES) BM-MNC, BM-MSC and germline (buccal swab and/or nails) samples of a cohort of 10 t-MN patients and 5 healthy donor (HD). Non-synonymous single nucleotide variants (SNVs) in coding regions or splicing sites with a variant allele frequency > 10% were considered in the analysis. Variants in highly repetitive regions or with minor allele frequency in 1000 Genomes of European origin > 0.01 were filtered out from the analysis.

**Results:** As a first step, we performed a call of the somatic variants in t-MN BM-MNCs and BM-MSCs using paired germline samples. In t-MN BM-MNCs, we identified a total of 150 SNVs and 141 mutated genes. As previously reported, TP53 was the most frequently mutated gene in MNC (4 out of 10 patients, 40%). A total of 133 SNVs and 132 mutated genes were identified in MSCs isolated from patients with a t-MN. Interestingly, the mutational profile of t-MN BM-MNC and BM-MSC was completely different, with no common genes mutated in the two cell types. Regarding somatic variants in BM-MSCs from t-MN, functional enrichment analysis revealed beta-alanine metabolism, complement and coagulation cascades, drug metabolism and serotonergic synapse as the most significantly enriched pathways. Interestingly, three

t-MN patients with primary solid tumors (30% of our cohort) presented somatic mutations in genes belonging to metabolic pathways such as DPYD, GMPS and UGT1A4, genes known to be involved in the catabolism of chemotherapy agents. Of note, none of the mutations identified in t-MN BM-MSCs were identified in BM-MSCs isolated from HD. In particular, we observed a statistically significant lower number of mutations in HD-MSCs compared to t-MN-MSCs (median 0 vs 6.5, range 0-2, 0-62, respectively,  $p < 0.001$ ).

**Conclusions:** Our results show a higher prevalence of somatic mutations in BM-MSCs isolated from t-MN patients compared to HD, that may be a direct consequence of the genotoxic activity of anticancer drugs action used to treat the primary disease. Functional validation of these findings is ongoing.

### C63

#### ANTINUCLEAR ANTIBODIES IN MYELODYSPLASTIC SYNDROME: A RETROSPECTIVE STUDY

A. Cristiano<sup>1</sup>, M. Nuccetelli<sup>2,3</sup>, H. Hajrullaj<sup>1</sup>, G. Falconi<sup>1</sup>, E. Galossi<sup>1</sup>, S. Fenu<sup>4</sup>, R. Latagliata<sup>5</sup>, A. Tafuri<sup>6</sup>, C. Sarlo<sup>7</sup>, R. Palmieri<sup>1</sup>, L. Maurillo<sup>1</sup>, A. Savi<sup>1</sup>, P. Niscola<sup>8</sup>, E. Papaemmanuil<sup>9,10</sup>, E. Bernard<sup>10</sup>, S. Bernardini<sup>2,3</sup>, E. Fabiani<sup>1,11</sup>, M.T. Voso<sup>1</sup>

<sup>1</sup>Department of Biomedicine and Prevention, Tor Vergata University, Rome, Italy; <sup>2</sup>Department of Experimental Medicine, Tor Vergata University, Rome, Italy; <sup>3</sup>Tor Vergata University Hospital, Rome, Italy; <sup>4</sup>Azienda Ospedaliera San Giovanni Addolorata, Rome, Italy; <sup>5</sup>Unità Operativa Complessa (UOC) Ematologia, Ospedale Belcolle, Viterbo and Division of Cellular Biotechnology and Hematology, Sapienza University, Rome, Italy; <sup>6</sup>Department of Clinical and Molecular Medicine, Hematology Sant'Andrea University Hospital, Sapienza University of Rome, Italy; <sup>7</sup>Hematology, University Campus Biomedico, Rome, Italy; <sup>8</sup>Haematology Unit, ASL Roma2, Saint Eugenio Hospital, Rome, Italy; <sup>9</sup>Cancer Genome Project, Wellcome Trust Sanger Institute, Hinxton, United Kingdom; <sup>10</sup>Department of Epidemiology and Biostatistics, Memorial Sloan Kettering Cancer Center, New York, USA; <sup>11</sup>UniCamillus-Saint Camillus International University of Health Sciences, Rome, Italy

**Introduction:** The myelodysplastic syndromes (MDS) are clonal hematopoietic disorders characterized by ineffective hematopoiesis and myeloid dysplasia. The simultaneous presence of autoimmune disorders (AD) and MDS has been reported in 10-30% of cases. Among the various autoimmune antibodies (autoAb) types, antinuclear antibodies (ANA) are the most frequently reported at the time of MDS diagnosis. Several AD were described concomitantly with MDS, but their impact on MDS progression and overall survival remains controversial. The aim of this retrospective study was to evaluate the incidence of autoAb in MDS patients, trying to correlate the presence of autoAb to the specific MDS subtype and their mutational landscape.

**Patients:** Patients from GROM-L group (Gruppo Romano-Laziale sindromi mielodisplastiche) were collected at "Policlinico Tor Vergata" Hospital of Rome (n=129). Targeted-NGS was performed in all samples, whereas the immunological profile was studied in 51/129 pts, based on plasma samples availability. The immunological analysis included autoAb commonly used for AD diagnosis as well as organ-specific AD. Samples were screened for ANA and its profile, ENA, anti-dsDNA, IgG/IgM anti-cardiolipin and anti- $\beta$ 2-glycoprotein-1, IgG anti-cyclic citrullinated protein antibodies (CCP3), IgG anti-MPO and IgG anti-PR-3.

**Results:** The immunological profile of 51 pts showed 61% ANA-positivity (n=31 pts) at a 1:80 cut-off, whereas, considering the AD clinically relevant cut-off (1:160), 14 pts (27%) were still scored ANA-positive. Following the diagnostic algorithm showed in Figure 1, the additional ANA profile, dsDNA and ENA, in ANA-positive patients (1:80 cut-off) was positive in 6%, 6% and 3% of pts, respectively, whereas for ANA titer 1:160, results were positive in 36%, 29% and 14% of cases, respectively. Although the number of patients studied is limited, we identified a trend for ANA-positivity in SF3B1 (10/12, 83%, vs 21/39, 53%,  $p=0.09$ ) and ASXL1-mutated patients (15/19, 79%, vs 16/32, 50%,  $p=0.07$ ). Preliminary results (n=22/51) on the other mentioned autoAb showed that one patient was positive for anti-CCP3 (suggestive of rheumatoid arthritis) and one for APCA (Anti-parietal cell antibodies, suggestive of autoimmune atrophic gastritis and/or pernicious anemia).

**Discussion:** In conclusion, our preliminary results show a high incidence (61%) of ANA-positivity in MDS patients, compared to data previously reported in healthy individuals (10-15%, PUBMED ID:). These data suggest that ANA-positivity could contribute to the pathogenesis of MDS, supporting an inflammatory status, where clonal hematopoiesis may expand and give raise to a clinically relevant MDS clone. Moreover, the low incidence of concomitant positivity to ANA and ENA profiles suggests that the detected ANA may not hit pathognomonic antigens of autoimmune diseases, but may target different cross-reactive proteins involved in non-well defined inflammatory processes.

### C64

#### CLINICAL AND PROGNOSTIC IMPACT OF BONE MARROW FIBROSIS IN MYELODYSPLASTIC SYNDROMES: A RETROSPECTIVE MONOCENTRIC STUDY

A. Bernardelli<sup>1</sup>, L. Crosera<sup>1</sup>, E. Lovato<sup>1</sup>, E. Tamellini<sup>1</sup>, C. Comparin<sup>1</sup>, I. Ferrarini<sup>1</sup>, C. Fraenza<sup>1</sup>, C. Visco<sup>1</sup>, R. Zanotti<sup>1</sup>, M. Bonifacio<sup>1</sup>, M. Krampera<sup>1</sup>, I. Tanasi<sup>1</sup>

<sup>1</sup>Department of Medicine, Section of Hematology, University of Verona, Italy

**Introduction:** Bone marrow fibrosis (BMF) may be found at diagnosis in 10 to 20% of patients with Myelodysplastic Syndromes (MDS) and has been suggested to be a poor prognostic factor. Nevertheless, few studies have explored the prognostic and therapeutic impact of BMF in patients stratified according to the IPSS and IPSS-R score or receiving hypomethylating agents (HMA) or allogeneic stem cell transplant (HSCT).

**Aim and methods:** The aim of our retrospective, monocentric, study was to assess the clinical and prognostic significance of BMF along with its impact on therapy response and outcome. The diagnosis of MDS was based on the 2016 World Health Organization (WHO) criteria and BMF grade was determined according to the European Myelofibrosis Network (EUM-NET) scoring system. Patients with myelodysplastic/myeloproliferative syndromes were excluded.

**Results:** Seventy two of 188 patients (38.3%) had BMF of grade 1 to 3. In this group, the median age at diagnosis was lower than patients without BMF (n=116, 61.7%; 65 vs 70 years, respectively,  $p < 0.01$ ) and a higher incidence of MDS-EB 1 or 2 (51.4% vs. 32.8%;  $p = 0.02$ ), secondary forms (20.8% vs 9.5%;  $p = 0.04$ ) as well as a higher transfusion dependence (69.4 % vs. 51.7%;  $p = 0.02$ ) were found. No differences in cytogenetics features were found. Furthermore, patients without BMF had a significant higher probability of being classified as low risk MDS, according to both IPSS ( $p=0.015$ ) and IPSS-R ( $p=0.02$ ), than patients with BMF (Figure 1).

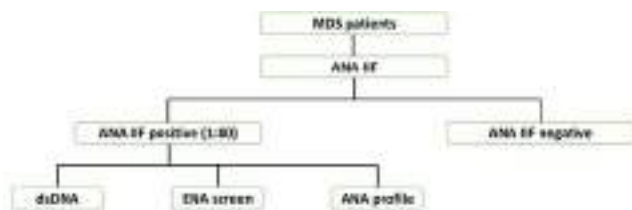

Figure 1.

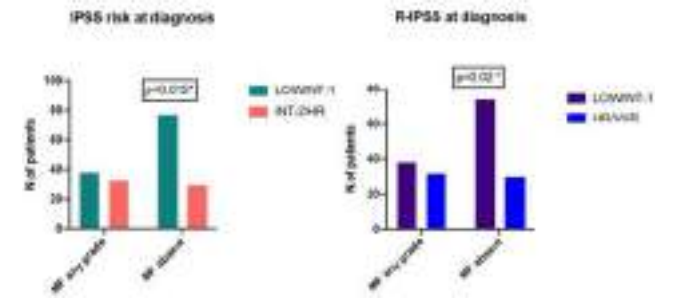

Figure 1. IPSS and IPSS-R at diagnosis according to BMF grade.

With a median follow up of 37 months, patients with any grade of BMF had an inferior overall survival rate (OS 37.5% vs 51.7%;  $p=0.04$ ). Of note, independently from the IPSS or IPSS-R risk, patients with moderate to severe BMF (grade  $\geq 2$ ;  $n=19/72$ , 26.4%) had a lower OS rate than patients with BMF grade 1 (26.3 vs 41.5 %, respectively;  $p=0.08$ ). BMF had no impact on survival in the low IPSS risk group ( $n=115/188$ , 61.1%), whereas patients with BMF  $\geq 2$  in the high IPSS group ( $n=11/61$ , 18%) had decreased OS compared to patients without BMF (9.1 vs 34.3% respectively;  $p=0.34$ ). In the HMA-treated group ( $n=54/188$ , 28.7%) no differences in response rates or outcome were observed, irrespective of the presence of BMF. Among transplanted patients ( $n=44/188$ , 23.4%), no correlation between BMF and time to engraftment was found, although patients with BMF ( $n=27/44$ , 61.4%) had a higher probability of developing Graft versus Host Disease (Hazard Ratio 1.7;  $p=0.06$ ). Moreover, transplanted patients with BMF  $\geq 2$  ( $n=10/44$ , 22.7%) had superior OS than patients with the same grade of BMF who did not proceed to HSCT (30 vs 12.5%,  $p=0.58$ ).

**Conclusions:** Our data confirm the negative prognostic role of BMF, partially abolished by HSCT. Although BMF is not included in the currently used risk scores, a careful evaluation at diagnosis may help to improve risk stratification and provide an additional indication to HSCT.

## Immunotherapy and Transplantation

### C65

#### REAL LIFE EXPERIENCE WITH COMMERCIAL CAR-T CELLS FOR LYMPHOMA PATIENTS: EARLY EXPANSION KINETIC PREDICTS DISEASE RESPONSE AND SURVIVAL

C. Monfrini<sup>1</sup>, V. Aragona<sup>1</sup>, M. Magni<sup>1</sup>, F. Stella<sup>2</sup>, C. Vella<sup>1</sup>, F. Nanetti<sup>1</sup>, E. Fardella<sup>2</sup>, A. Chiappella<sup>1</sup>, A. Dodero<sup>1</sup>, A. Guidetti<sup>1,2</sup>, M. Pen-nisi<sup>1</sup>,

C. Carniti<sup>1</sup>, P. Corradini<sup>1,2</sup>

<sup>1</sup>Fondazione IRCC Istituto Nazionale dei Tumori; <sup>2</sup>Facoltà di Medicina, Università degli Studi di Milano, Italy

**Introduction:** Although Tisa-cel and Axi-cel are becoming widely used as standard-of-care therapy for lymphoma patients (pts), key determinants of response are not well characterized. Clinical features such as poor PS, high systemic inflammatory state, tumor burden and LDH represent markers of lower efficacy in some studies. However, response and survival do not appear to be influenced by pts characteristics in other reports and the role of CAR-T expansion in peripheral blood has never been prospectively investigated in a real life setting. Aim was to correlate Axi-cel and Tisa-cel in-vivo expansion and lymphoma response, survival and CRS.

**Methods:** This single centre prospective study evaluated 50 large B-cell lymphoma pts (26 DLBCL-NOS, 9 HGBCL, 7 tFL, 8 PMBCL) receiving Tisa-cel (23; 46%) and Axi-cel (27; 54%) and explored the feasibility and prognostic role of monitoring CAR-T cell using flow cytometry. Data were acquired on MACSQuant Analyzer (Miltenyi).

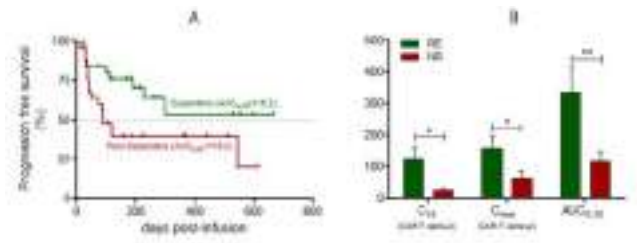

Figure 1.

**Results:** At a median follow-up of 325 days (range 33-667), median PFS was 302 days and median OS was not reached. No statistically significant differences in PFS or OS were detected between Tisa-cel and Axi-cel treated pts (PFS: median 192 vs 302 days; OS: median 582 days vs not reached; Pns). The in-vivo expansion kinetics of Tisa-cel and Axi-cel were also similar. We then examined whether CAR-T cell expansion was associated with response and survival. Median time to peak expansion ( $T_{max}$ ) was 10 days for both products with no significant differences neither in the number of CAR+ cells/ $\mu$ l at day 10 ( $C_{10}$ : median 30.5 for Tisa-cel vs 23 for Axi-cel; Pns) nor in the concentration of CAR+ cells at the  $T_{max}$  ( $C_{max}$ : median 52 CAR+ cell/ $\mu$ l for Tisa-cel vs 54 for Axi-cel; Pns) nor in the magnitude of expansion up to 30 days ( $AUC_{0-30}$ : median 123 for Tisa-cel vs 113 for Axi-cel; Pns). When the median  $AUC_{0-30}$  (118.2) was used as a surrogate for CAR-T cell expansion and was set as the cut-off to discriminate “expanders” (EX;  $n=25$ ; 50%) and “poor-expanders” (PEX;  $n=25$ ; 50%). Expanders had a significantly longer PFS compared to PEX (PFS median: not reached in EX vs 93 days in PEX;  $P<0.05$ )(A). Of note, 14 (56%) pts with  $AUC_{0-30}<118.2$  relapsed by day 90, as compared to 6 (24%) pts with  $AUC_{0-30}\geq 118.2$ . Moreover, EX exhibited significantly higher response rates than PEX (OR4.030; CI95% 1.201-13.53;  $P<0.056$ ) whereas no significant correlation between grade  $\geq 2$  CRS and expansion was observed (OR2.471; 95%CI 0.6339-9.629; Pns). Additionally pts in CR and PR (responders, RE;  $n=30$ ; 60%) by PET/CT by day 90, had significantly higher  $C_{10}$ ,  $T_{max}$  and  $AUC_{0-30}$  when compared to non-responders (PD and SD, NR;  $n=20$ ;



40%) ( $C_{10}$ : median 43.7 in RE vs 13.7 in NR;  $P < 0.05$ ;  $C_{max}$ : median 78.6 in RE vs 25.3 in NR;  $P < 0.05$ ;  $AUC_{0-30}$ : median 161.9 in RE vs 61.1 in NR;  $P < 0.01$ )(B).

**Conclusion:** To the best of our knowledge, this is the first study demonstrating the clinical utility of CAR-T cell monitoring in lymphoma pts receiving Tisa-cel and Axi-cel.

## C66

### CXCR4-MODIFIED CD33.CAR-CIK WITH ENHANCED BONE MARROW HOMING IN ACUTE MYELOID LEUKEMIA

M. Biondi<sup>1</sup>, B. Cerina<sup>1</sup>, C. Tomasoni<sup>1</sup>, G. Dotti<sup>2</sup>, S. Tettamanti<sup>1</sup>, A. Biondi<sup>1</sup>, A. Pievani<sup>1</sup>, M. Serafini<sup>1</sup>

<sup>1</sup>Tettamanti Research Center, Department of Pediatrics, University of Milano-Bicocca, Fondazione MBBM/San Gerardo Hospital; <sup>2</sup>Lineberger Comprehensive Cancer Center, University of North Carolina Chapel Hill

Chimeric Antigen Receptor (CAR) Cytokine-Induced Killer cells (CIKs)-cell therapy for acute myeloid leukemia (AML) may be limited by dampened effector cells trafficking to the bone marrow (BM) niche, where leukemia stem cells (LSCs) reside. The chemokine receptor 4 (CXCR4) and its ligand, CXC motif ligand 12 (CXCL12) regulate leukocytes trafficking to the niche. In AML, CXCL12, secreted by mesenchymal stromal cells (MSCs), binds CXCR4 overexpressed on blasts, promoting their homing in the BM. CXCR4 expression on CIKs is drastically down-regulated during culture. Combining expression of CD33.CAR and CXCR4 might therefore facilitate CAR-CIK homing to the BM allowing more efficient targeting of LSCs in the leukemic niche. Two bicistronic Sleeping Beauty transposon vectors were designed: CXCR4(IRES)CD33.CAR and CD33.CAR(2A)CXCR4. The monocistronic CD33.CAR was used as control. Migration *in vitro* toward rhCXCL12 or MSC supernatants was tested using a transwell migration assay. CAR-CIKs *in vivo* BM homing ability was evaluated in sub-lethally irradiated NSG mice. We noticed that both CD33.CAR(2A)CXCR4-CIKs ( $n=22$ ,  $P < 0.0001$ ) and CXCR4(IRES)CD33.CAR-CIKs ( $n=9$ ,  $P < 0.0001$ ) maintained CXCR4 overexpression during culture, whereas in CD33.CAR-CIKs was drastically downregulated ( $n=22$ ). Nevertheless, CD33.CAR expression was lower in CXCR4(IRES)CD33.CAR-CIKs ( $n=8$ ,  $P < 0.0001$ ) compared to CD33.CAR-CIKs, while CD33.CAR(2A)CXCR4-CIKs ( $n=11$ ) exhibited a significant co-expression of both proteins against control ( $P=0.001$ ). Therefore, CD33.CAR(2A)CXCR4 construct was chosen to proceed with further investigations. Noticeably, CD33.CAR-CXCR4-CIKs maintained all CAR-related *in vitro* effector functions, eliminating CD33<sup>+</sup> KG1 and MOLM14 target cell lines, releasing cytokines (IL-2 and IFN- $\gamma$ ) and proliferating in an antigen-specific fashion. Furthermore, CD33.CAR-CXCR4-CIKs displayed improved migratory response toward rhCXCL12 as compared to CD33.CAR-CIKs ( $n=10$ ,  $P < 0.0001$ ). Moreover, to mimic the conditions of the BM microenvironment, we employed supernatant of MSCs derived from healthy donors (HD) ( $n=6$ ) or AML patients at diagnosis ( $n=10$ ) as a chemotactic stimulus. CD33.CAR-CXCR4-CIKs still demonstrated an increased chemotactic response compared to control, which could be inhibited by CXCR4 antagonist Plerixafor. Notably, 7 days after infusion into sub-lethally irradiated NSG mice, CD33.CAR-CXCR4-CIKs presented a significant increase in their ability to enter the BM compartment when compared to CD33.CAR-CIKs. Contrarily, CD33.CAR-CXCR4-CIK frequency in peripheral blood and spleen displayed only minimal differences compared to control. Overall CD33.CAR(2A)CXCR4-CIKs display enhanced *in vitro* migration and superior *in vivo* BM homing ability while maintaining CAR functionalities. This boosted migratory potential might facilitate an improved clearing of CD33<sup>+</sup> AML blasts and LSCs residing in the BM, which is being explored in ongoing experiments.

## C67

### OBSERVATIONAL MULTICENTRIC STUDY FOR INVESTIGATING IMMUNOPHARMACOLOGICAL RESPONSE TO BLINATUMOMAB IN B-ALL PATIENTS. A CAMPUS ALL STUDY

D. Ocadlikova<sup>1</sup>, G. Corradi<sup>1</sup>, F. Lussana<sup>2</sup>, N. Fracchiolla<sup>3</sup>, M. Bonifacio<sup>4</sup>, L. Santoro<sup>5</sup>, M. Delia<sup>6</sup>, S. Chiaretti<sup>7</sup>, C. Pasciolla<sup>8</sup>, A. Cignetti<sup>9</sup>, F. Forghieri<sup>10</sup>, L. Zannoni<sup>1</sup>, S. De Propris<sup>7</sup>, G.M. Borleri<sup>2</sup>, I. Tanasi<sup>4</sup>, A.R. Guarini<sup>11</sup>, R. Foà<sup>7</sup>, A. Curti<sup>12</sup>, on behalf of the Campus ALL

<sup>1</sup>Dipartimento di Medicina Specialistica, Diagnostica e Sperimentale, Università di Bologna, Istituto di Ematologia "Seragnoli"; <sup>2</sup>ASST Papa Giovanni XXIII, U.O. di Ematologia e Trapianto di Midollo Osseo; <sup>3</sup>Fondazione IRCCS Ca' Granda Ospedale Maggiore Policlinico, U.O. di Ematologia; <sup>4</sup>Dipartimento di Medicina, U.O. di Ematologia, Università di Verona; <sup>5</sup>AO "S. Giuseppe Moscati"; <sup>6</sup>U.O.C. Ematologia e Trapianto, AOUC Policlinico; <sup>7</sup>Dipartimento di Medicina Traslationale e di Precisione, "Sapienza" Università di Roma; <sup>8</sup>IRCCS Istituto Tumori "Giovanni Paolo II"; <sup>9</sup>SCDU Ematologia e Terapie Cellulari, AO Ordine Mauriziano; <sup>10</sup>U.O. di Ematologia, Dipartimento di Scienze Mediche e Chirurgiche Materno-Infantili e dell'Adulto, Università di Modena e Reggio Emilia, AOU di Modena; <sup>11</sup>Dipartimento di Medicina Molecolare, Università "Sapienza", Roma; <sup>12</sup>IRCCS Azienda Ospedaliero-Universitaria di Bologna, Istituto di Ematologia "Seragnoli", Italy

**Introduction:** Bi-specific T-cell engagers (BiTE) are a class of bispecific antibodies designed for cancer immunotherapy. Blinatumomab is the first approved BiTE for the treatment of relapsed or refractory (R/R) and minimal residual disease (MRD)-positive Philadelphia chromosome-negative B-cell precursor acute lymphoblastic leukemia (ALL). It brings killer T and target B cells into close proximity, thus activating patients' autologous T cells against malignant B cells. In spite of significant clinical results, the immunological mechanisms underlying blinatumomab activity are not fully elucidated. In particular, the modulation of immune cell subtypes and the expression of stimulatory or inhibitory molecules on T-cell subsets induced *in vivo* by blinatumomab still warrant further investigation and characterization.

**Objective:** To study modifications in immune cell subsets before, during and after blinatumomab treatment and to evaluate their association with response.

**Methods:** Twenty-nine patients with B-ALL (20 with MRD positivity and 9 with R/R disease; 11 Ph+ and 18 Ph- ALL) received blinatumomab according to clinical practice or expanded access programs. Multi-parametric flow-cytometry was used to provide extensive characterization of lymphoid subsets such as B, T and NK cells from peripheral blood at baseline, on day +14 during treatment and at the end of the cycle.

**Results:** During treatment, an increase of cytotoxic NK cells and a decrease of total Tregs and their subsets were observed. An increase of immune check-point receptors - such as PD-1, CTLA-4, Gal-9, Lag-3 and Tim-3 - on T cells was observed, mostly restricted to the effector memory CD8 subset. Interestingly, CD39 resulted significantly upregulated on a subset of effector Tregs. With regard to blast cells, expression of PD-L1 and Tim-3 was also increased during therapy. At baseline, only Tregs, especially naïve Tregs expressing CD39, were negatively associated with a reduced response. During and after treatment, significant associations with response were observed for: 1) non-cytotoxic NK cells, which were reduced in responders; 2) PD-1-expressing effector CD4 T cells and central memory CD8 T cells, which were increased in non-responders; 3) Tim-3-expressing CD4 and CD8 T cells, which were strongly associated with a reduced response.

**Conclusions:** These results indicate that different subsets of NK and T cells, including Tregs, are significantly modulated by blinatumomab treatment. Analysis of the association with response may suggest that the expression of PD-1 and, interestingly, of Tim-3 on effector CD8 T cells may be relevant for the immunopharmacological effect of blinatumomab on the immune cell compartment, representing a potential on-treatment resistance mechanism. To support and confirm these data, further studies on a larger cohort of patients and a functional set of experiments are warranted.

## C68

T-CELL PHENOTYPES OF COMMERCIAL AXI-CEL AND TISA-CEL CAR-T PRODUCTS AFFECT *IN VIVO* EXPANSION AND THUS RESPONSE

V. Aragona<sup>1</sup>, C. Monfrini<sup>1</sup>, M. Magni<sup>1</sup>, C. Vella<sup>1</sup>, F. Stella<sup>2</sup>, F. Nanetti<sup>1</sup>, E. Fardella<sup>2</sup>, A. Chiappella<sup>1</sup>, A. Doderò<sup>1</sup>, A. Guidetti<sup>1,2</sup>, M. Pennisi<sup>1</sup>, C. Carniti<sup>1</sup>, P. Corradini<sup>1,2</sup>

<sup>1</sup>Fondazione IRCC Istituto Nazionale dei Tumori; <sup>2</sup>Facoltà di Medicina, Università degli Studi di Milano, Italy

**Introduction:** Although therapy with Tisagenlecleucel/Tisa-cel and axicabtageneclisoleucel/Axi-cel is becoming widely used as standard-of-care for lymphoma patients, key determinants of response are not well characterized. A number of studies have indicated that clinical features such as poor PS, high systemic inflammatory state, high tumor burden and LDH represent markers associated with lower efficacy. However, response and survival do not appear to be influenced by patients characteristics in other reports and the role of CAR-T bag content has never been investigated in a real life situation. Aim of the study was to evaluate whether the phenotype of the CAR-T contained in the infusion bags could influence *in vivo* CAR-T cell expansion and thus response and patients survival.

**Methods:** We immunophenotyped residual cells after washing the products bags obtained from 58 infused commercial CAR-Ts (26 Tisa-cel and 32 Axi-cel). Cells were stained with the biotinylated CD19-CAR detection reagent (Miltenyi), CD45, 7-AAD, CD3, CD4, CD8, CD45RO, CD62L and CCR7. Cell acquisition was performed on a MACSQuant® Analyzer MQ10 (Miltenyi) and a BD FACSCanto II (BD Biosciences) and data analyzed using the MACSQuantify Software and FlowJo software. Circulating CAR-T cell expansion was longitudinally monitored in 53 treated patients.

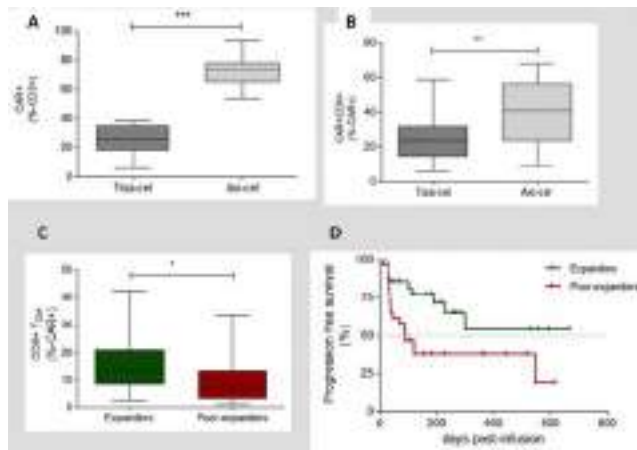

Figure 1.

**Results:** In left-over bags, median CAR+ cells were 58.6% (range 93%-5.8%) of CD3+ cells. The median percentage of CAR+/CD4+ was 63.36% (range 89.91%-26.13%) and of CAR+/CD8+ was 33.32% (range 68.21%-8.47%). When comparing the two different products, in Tisa-cel bags (n=26) we detected a lower fraction of CAR+ (Figure 1A) and of CAR+/CD8+ (Figure 1B) cells as compared to Axi-cel bags (n=32) (median CAR+ cells: 25.37% vs 72.87%, P<0.0001; median CAR+/CD8+ cells: 25.06% vs 40.85%, P<0.005). We then assessed the impact of CAR-T bag phenotypic features on CAR T cell expansion in the patient peripheral blood. The magnitude of expansion was calculated as the area under the curve (AUC<sub>0-30</sub>) over the first month after infusion and the median AUC<sub>0-30</sub> was used as the cutoff to segregate “expanders” and “poor-expanders”. Expanders (27 pts; AUC<sub>0-30</sub>≥123) received infusion products enriched in CAR+/CD8+ cells with a T Central Memory (T<sub>CM</sub>) phenotype [CD45RO+CCR7+CD62L+] as compared to poor-expanders (26 pts; AUC<sub>0-30</sub><123) (median CAR+/CD8+ T<sub>CM</sub>: 13.4% vs

6.8%, P<0.05) (Figure 1C). Of note, the “expander” group was enriched in patients achieving CR or PR (n=19 and n=2, respectively) at day 90 post-infusion (OR 4.030; CI 95% 1.201-13.53; P<0.05) and was characterized by a significantly longer progression free survival as compared to the “poor-expander” group (PFS: unreached in “expanders” vs 93 days in “poor-expanders”, P<0.05) (Figure 1D).

**Conclusions:** Collectively, our data indicate that the features of CAR+ cells in the infusion bags are relevant for *in vivo* CAR-T cell expansion that ultimately translates into a better lymphoma response and longer survival.

## C69

## MOLECULAR MEASURABLE RESIDUAL DISEASE ASSESSMENT BEFORE HEMATOPOIETIC STEM CELL TRANSPLANTATION IN PEDIATRIC ACUTE MYELOID LEUKEMIA PATIENTS: A RETROSPECTIVE STUDY BY THE I-BFM STUDY GROUP

M. Benetton<sup>1</sup>, P. Merli<sup>2</sup>, C. Walter<sup>3</sup>, M. Hansen<sup>4</sup>, A. Da Ros<sup>1</sup>, K. Polato<sup>1</sup>, C. Tregnago<sup>1</sup>, J. Abrahamsson<sup>5</sup>, L. Strocchio<sup>2</sup>, E. Sonneveld<sup>6</sup>, L. Fogelstrand<sup>7-8</sup>, N. von Neuhoff<sup>3</sup>, D. Reinhardt<sup>3</sup>, H. Hasle<sup>4</sup>, M. Pigazzi<sup>1-9</sup>, F. Locatelli<sup>2-10</sup>

<sup>1</sup>Divisione di Emato-Oncologia Pediatrica e Terapia Cellulare e Genica, Dipartimento di Salute della Donna e del Bambino, Università degli Studi di Padova; <sup>2</sup>Dipartimento di Oncoematologia Pediatrica, IRCCS Ospedale Pediatrico Bambino Gesù; <sup>3</sup>Department of Pediatric Hematology and Oncology, University Hospital Essen; <sup>4</sup>Department of Pediatrics, Aarhus University Hospital; <sup>5</sup>Department of Pediatrics, Institute of Clinical Sciences, Sahlgrenska Academy at University of Gothenburg; <sup>6</sup>Princess Máxima Center for Pediatric Oncology; <sup>7</sup>Department of Clinical Chemistry, Sahlgrenska University Hospital; <sup>8</sup>Department of Laboratory Medicine, Institute of Biomedicine, University of Gothenburg; <sup>9</sup>Fondazione Istituto di Ricerca Pediatrica-Città della Speranza; <sup>10</sup>Dipartimento di Pediatria, Sapienza, Università di Roma

**Introduction:** Acute myeloid leukemia (AML) is a heterogeneous disease where selected genetic subgroups of patients, linked by the presence of biological and clinical high-risk features, are candidates to receive allogeneic hematopoietic stem cell transplantation (HSCT) as post-remission consolidation treatment, however relapse still remains the most common cause of treatment failure. In the last decade, multiparameter flow cytometry and PCR-based approaches to quantify measurable residual disease (qPCR-MRD) have been largely used after induction course, but its role before HSCT is still debated, especially in the pediatric setting. Several studies identified the presence of qPCR-MRD as a debated predictor of relapse due to a lack of standardized protocols developed in international networks, and to different cut-offs and time-points.

**Methods:** To address this issue, we conducted the first I-BFM-AML collaborative retrospective study to measure qPCR-MRD in bone marrow aspirates collected in five european laboratories within 4 weeks prior to HSCT of 112 pediatric AML patients harboring one of the main recurrent AML genetic markers t(8;21)(q22;q22)RUNX1-RUNX1T1, inv(16)(p13.1q22)/t(16;16)(p13.1;q22)CBFB-MYH11, t(9;11)(p22;q23)KMT2A-MLLT3 or FLT3-ITD.

**Results:** We calculated by ROC curve a cutoff of  $2.1 \times 10^{-4}$  that revealed significant increased OS (83.7% vs 57.1%) and EFS (80.2% versus 52.9%) for those patients whose qPCR-MRD was below the cutoff (n=64). Moreover, children who had qPCR-MRD> $2.1 \times 10^{-4}$  had a higher risk to relapse (CIR=26%) with respect to those with low qPCR-MRD levels (CIR=10%, p=0.031). Analyzing the influence of qPCR-MRD levels on outcome for each molecular marker, we found that qPCR-MRD< $2.1 \times 10^{-4}$  significantly influenced OS and EFS in FLT3-ITD patients (OS 100% vs 62.5%, p=0.019), and in t(8;21)RUNX1-RUNX1T1-rearranged patients (OS 83.8% vs 49.7%, p=0.045), but for the remaining genetic lesions, qPCR-MRD did not play a significant role, even if the power of these analyses is limited by a reduced sample size. Then, we combined two different thresholds,  $2.1 \times 10^{-4}$  and  $1 \times 10^{-2}$ , and we partitioned patients in 3 groups having low, intermediate, and high residual disease: the 5-year OS (83.7%, 68.6% and 39.2% respec-

tively) and relapse-free survival (89.2%, 73.9%, 67.9%) significantly differed among the 3 groups independently of the genetic lesion, conditioning regimen, donor and stem cell source. Finally, by multivariate Cox regression analysis, we revealed that low/undetectable qPCR-MRD levels had a favorable effect on outcome as independent prognostic factor for both OS and EFS ( $p=0.0011$ ).<sup>t</sup>

**Conclusions:** In conclusion, these data support the PCR-based approach playing a clinical relevance in AML transplant management.

## C70

### TARGETING THE CD6-ALCAM T CELL COSTIMULATORY PATHWAY AFTER ALLOGENEIC CELL TRANSPLANTATION FOR ACUTE GRAFT VERSUS HOST DISEASE (aGVHD) TREATMENT USING ANTI-CD6 MONOCLONAL ANTIBODY ITOLIZUMAB

B. Rambaldi<sup>1,2</sup>, H.T. Kim<sup>3</sup>, Y. Arihara<sup>1,4</sup>, T. Asano<sup>1,5</sup>, C. Reynolds<sup>1</sup>, M. Manter<sup>1</sup>, M. Halpern<sup>1</sup>, A. Weber<sup>1</sup>, J. Koreth<sup>1</sup>, C. Cutler<sup>1</sup>, M. Gooptu<sup>1</sup>, S. Nikiforow<sup>1</sup>, V.T. Ho<sup>1</sup>, J.H. Antin<sup>1</sup>, R. Romee<sup>1</sup>, J. Ampudia<sup>6</sup>, C. Ng<sup>6</sup>, S. Connelly<sup>6</sup>, R.J. Soiffer<sup>1</sup>, J. Ritz<sup>1</sup>

<sup>1</sup>Department of Medical Oncology, Dana-Farber Cancer Institute and Harvard Medical School; <sup>2</sup>Ph.D. Program in Translational and Molecular Medicine (DIMET), University of Milano-Bicocca; <sup>3</sup>Department of Data Science, Dana-Farber Cancer Institute, Harvard T H Chan School of Public Health; <sup>4</sup>Department of Medical Oncology, Sapporo Medical University; <sup>5</sup>Department of Hematology and Oncology, Himeji Red Cross Hospital; <sup>6</sup>Equillium

CD6 is a co-stimulatory receptor expressed on T cells that binds activated leukocyte cell-adhesion molecule (ALCAM), a ligand expressed on antigen presenting cells, epithelial and endothelial tissues. The CD6-ALCAM pathway plays an integral role in modulating T cell activation, proliferation and trafficking. The aim of this study was to characterize expression of CD6 and ALCAM early after hematopoietic cell transplantation (HCT) and to examine the effects of Itolizumab on T cell responses during aGVHD. We analyzed immune reconstitution in 95 adult patients who underwent allogeneic HCT at the Dana-Farber Cancer Institute between September 2018 and January 2020. Blood samples were obtained at 1, 2, 3 and 6 months after transplant for analysis of CD6 and ALCAM expression, using multicolor flow cytometry panels.

Peripheral blood samples from 9 healthy donors (HD) were used as controls. Median follow-up among survivors was 12 months (range, 4-20). Acute GVHD occurred in 42 patients (44.2%) at a median of 50 days after transplant (range 20-294 days). aGVHD grade severity was 38.1%, 40.5%, 7.1% and 14.3% of grade I, II, III and IV, respectively. Four patients (11.8%) developed steroid refractory acute GVHD. Suppressive activity of itolizumab was tested in vitro using peripheral blood mononuclear cells (PBMC) obtained from HD and patients before (preGVHD) and after (postGVHD) aGVHD onset. To test if Itolizumab activity was dependent to the presence of the CD6 cognate ligand, ALCAM, HD isolated CD3+ T cells were stimulated with antiCD3 antibody with or without ALCAM-Fc for 96 hours. CD6 T cells reconstituted early after transplant with CD4Treg expressing lower levels of CD6 compared to CD4Tcon and CD8 T cells (Figure 1A). After onset of aGVHD, CD6 expression was further reduced in CD4Treg and CD8 T cells compared to healthy donors, while no difference was observed for CD4Tcon (Figure 1B). ALCAM expression was highest in plasmacytoid dendritic cells (pDC), lowest in myeloid dendritic cells (mDC) and intermediate in monocytes (Figure 1C) and was generally increased after GVHD onset (Fig 1D). Itolizumab inhibited CD4 and CD8 T cell proliferation, activation and maturation in preGVHD samples, but inhibition was less prominent in samples collected after GVHD onset, especially for CD8 T cells (Figure 1E). Itolizumab does not induce complement dependent cytotoxicity, antibody dependent cytotoxicity or antibody direct cellular cytotoxicity (data not shown). Itolizumab efficiently inhibited T cell proliferation in the presence of ALCAM-Fc and antiCD3 antibody, while no effect was observed in the presence of antiCD3 antibody alone, suggesting that Itolizumab activity is dependent on the presence of ALCAM in the system (Figure 1F). In conclusion, our results identify the CD6-ALCAM pathway as a potential target for aGVHD control and a phase I/II study using itolizumab as first line treatment in combination with

steroids for patients with acute GVHD is currently ongoing (NCT03763318).

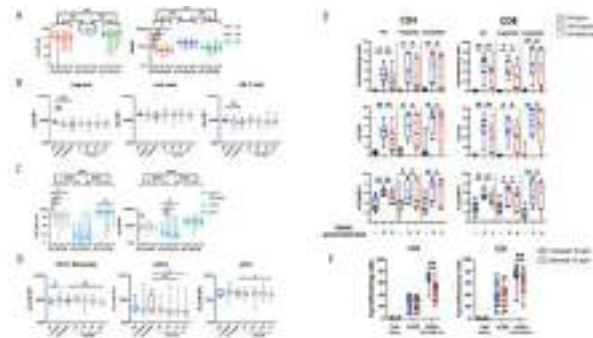

**Figure 1.** CD6 and ALCAM expression after HCT and Itolizumab *in vitro* activity. A) percentage of CD6+ cells and CD6 median fluorescence intensity (MFI) in regulatory T (Treg, defined as CD3+CD4+CD25+CD127-) cells, conventional T (Tcon, defined as non-Treg CD3+CD4+) cells, and CD8+ T cells from HD, n=9 and from patients after hematopoietic cell transplantation (HCT) at 1 month (n=67), 2 months (n=76), 3 months (n=78) and 6 months (n=35); B) comparison of CD6 MFI regarding GVHD onset on Treg, Tcon and CD8+ T cells; HD n=9, preGVHD n=30, postGVHD n=20, noGVHD 1-month (1m) n=38, 2-months (2m) n=40, 3-months (3m) n=43 and 6-months (6m) n=21; C) Percentage of ALCAM positive cells and ALCAM MFI on CD14+ monocytes (grey boxes), myeloid DC (mDC, lineage-HLA-DR+CD11c+CD123-, light-blue boxes) and plasmacytoid DC (pDC, lineage-HLA-DR+CD11c-CD123+, green boxes) in HD and in patients at 1, 2, 3 and 6 months after HCT; D) comparison of ALCAM MFI regarding GVHD onset on CD14+ monocytes, mDC and pDC. E) Itolizumab activity on CD4 and CD8 positive T cells after 72 hours stimulation with antiCD3/CD2/CD28 coated beads on T cell proliferation, CD25 expression as a marker of T cell activation and CD45RO expression as a marker of T cell maturation. HD, n=9; preGVHD, n=7; postGVHD, n=8. Iso Ab: Isotype antibody (Cetuximab); F) Itolizumab activity on CD4+ and CD8+ T cell proliferation after stimulation with plate-bound antiCD3 (5 µg/ml) with or without ALCAM-Fc (10 µg/ml) of isolated CD3+ T cell; HD, n=10. Box and whiskers show median and range. Non-parametric paired (Wilcoxon matched-pairs signed rank) test were used for statistical analysis. \* $p<0.05$ ; \*\* $p<0.01$ ; \*\*\* $p<0.001$ .

## C71

### ANTIBODIES KINETIC AND CELL-MEDIATED RESPONSE AFTER COMIRNATY ANTI SARS-COV2 VACCINE IN RECIPIENTS OF HEMATOPOIETIC STEM CELLS ALLOGENEIC TRANSPLANTATION

U. Pizzano<sup>1</sup>, F. Patriarca<sup>1</sup>, G. Facchin<sup>1</sup>, F. Curcio<sup>2</sup>, M. Fabris<sup>2</sup>, R. Peressutti<sup>3</sup>, C. Tascini<sup>4</sup>, R. Fanin<sup>1</sup>

<sup>1</sup>Clinica di Ematologia e Centro Trapianti e Terapie Cellulari, Università di Udine e ASUFC; <sup>2</sup>Dipartimento di Medicina di Laboratorio, Università di Udine e ASUFC; <sup>3</sup>Centro Regionale Trapianti, Regione Friuli Venezia-Giulia; <sup>4</sup>Clinica di Malattie Infettive, Università di Udine e ASUFC, Italy

**Introduction:** Patients undergoing allogeneic stem cell transplantation (allo-SCT) are likely to have reduced responses to vaccines due to immunosuppressive status linked to GVHD prophylaxis and treatment. The objective of our study was to compare humoral responses to SARS-Cov-2 vaccine according to patients and transplant features, and to evaluate cellular responses in patients without anti-spike antibodies.

**Methods:** We tested anti-spike protein antibodies in 74 patients 30 and 90 days after the second dose of Comirnaty anti SARS-Cov2 vaccine. All patients had received an allo-SCT at least 3 months before the first dose. Anti-spike protein antibodies were detected through an immunoenzymatic assay with a positivity cut-off of 0,79 U/ml. We evaluated a possible association between anti-spike protein positivity and the following patient and transplant characteristics: patient age, hematological disease, GVHD prophylaxis, allo-SCT timing, GVHD occurrence, ongoing immunosuppressive treatment. Moreover, in a group of patients with an anti-spike titer below the cut-off we evaluated cell-mediated responses through the Quantiferon method based on interferon gamma released by

patients' T-lymphocytes exposed to the SARS-CoV2 virus spike protein.

**Results:** 49 of 74 patients (66%) had a positive antibody titer 30 days after the vaccine and this percentage increase to 81% (50 of the evaluable 62 patients) after 90 days. We found a significant association between antispikes positivity and longer interval between allo-SCT and first vaccine dose: in fact, a positive humoral response was detected in 38/51 patients (75%) at 30 days and in 37/40 patients (93%) at 90 days, if the interval between allo-SCT and first dose was longer than 12 months (Late Group), in comparison with 11 positive patients (48%) at 30 days, and 13 positive (59%) at 90 days in case of allo-SCT-vaccine interval shorter than 12 months (Early Group) ( $p=0.047$  and  $p=0.0043$ , respectively). Moreover, antibody titer median value was significantly higher in Late Group in comparison with Early Group: 1149,3 U/ml vs 185,4 U/ml at 30 days, and 1236,9 U/ml vs 212,4 U/ml at 90 ( $p < 0,05$ ). Moreover, patients with ongoing immunosuppressive treatment at the time of vaccine had a significant lower rate of antispikes positivity in comparison with patients with calcineurin inhibitors withdrawal ( $p=0.008$  at 30 days and  $p=0.001$  at 90 days). There was no association between humoral response and patient age, hematological disease, GVHD prophylaxis and GVHD occurrence. 19 patients with negative anti-Spike antibodies were tested for cell-mediated response and 12 (63%), all belonging to the Early Group, showed negative results.

**Conclusions:** Our study suggested that an interval shorter than 12 months between allo-SCT and first vaccine dose and/or ongoing immunosuppressive treatment were associated with deficiency of humoral and cellular response and indicated the need of a booster vaccine dose.

**C72**

**MICRO-RNA CARGO IN SERUM EXTRACELLULAR VESICLES AND ACUTE GRAFT VERSUS HOST DISEASE AFTER ALLOGENEIC STEM CELL TRANSPLANTATION**

G. Lia<sup>1,2</sup>, L. Brunello<sup>1,2</sup>, M. Tapparo<sup>5</sup>, S. Bruno<sup>5</sup>, S. Butera<sup>1</sup>, G. Gabrielli<sup>1</sup>, D.G. Faraci<sup>1</sup>, M. Fasci<sup>1,2</sup>, L. Giaccone<sup>1,2</sup>, D. Ferrero<sup>1,2,3</sup>, A. Evangelista<sup>4</sup>, G. Camussi<sup>5</sup>, B. Bruno<sup>1,2,6</sup>

<sup>1</sup>Stem Cell Transplant Program, Department of Oncology, A.O.U. Città della Salute e della Scienza di Torino; <sup>2</sup>Department of Molecular Biotechnology and Health Sciences, University of Torino; <sup>3</sup>Department of Oncology, A.O.U. Città della Salute e della Scienza di Torino; <sup>4</sup>Clinical Epidemiology, A.O.U. Città della Salute e della Scienza di Torino; <sup>5</sup>Department of Medical Sciences, Molecular Biotechnology Center, University of Torino; <sup>6</sup>Division of Hematology and Medical Oncology, NYU Grossman School of Medicine, Perlmutter Cancer Center, NYU Langone Health

**Introduction:** Acute graft-versus-host disease (aGVHD) remains a major clinical challenge after allografting (allo-SCT) and biomarkers that may reliably predict its onset have not yet been identified. We recently investigated the potential role of serum and plasma extracellular vesicles (EVs) as “non-invasive” biomarkers of aGVHD (Lia G. et al. Leukemia 2018; Lia G. Hematologica 2020). In this study we characterized the microRNAs (miRNAs) cargo shuttled by serum EVs and their correlation with the risk of developing aGVHD in patients undergoing allo-SCT.

**Methods:** Serum samples were prospectively collected at given time-points (pre-transplant, on day (median) 0, 3, 7, 14, 21, 28, 35, 45, 54, and 60, on months 2, 3, 4, 5, and 6 after transplant) from 85 consecutive patients. EVs were extracted by a precipitation method and characterized by the guidelines of the Minimal information for studies of extracellular vesicles 2018. Total RNA content was extracted from EVs (miRNeasy Mini Kit, Qiagen), reverse transcribed to cDNA (miScript II RT Kit, Qiagen) and six miRNAs (miR100, miR194, miR155, miR146, miR29 and miR153) were quantified by qRT-PCR (miScript SYBR Green PCR Kit, Qiagen). Global mean normalization (including quantification of miR92b and RNU6b) was used to normalize RT-qPCR data. Associations between miRNAs expression level (both absolute [abs] and change from basal level [delta]) and aGVHD onset was evaluated by logistic regression models for each marker. All statistical analyses were performed

using STATA 15 (Stata Corp LP) and SPSS Statistics 25 (IBM SPSS Statistics).

**Results:** Cumulative incidence of grade II-IV aGVHD at 3 months was 53% (95% confidence interval: 43.23–65.39%) (45/85 patients) with a median day of onset of 35. Logistic regression model showed that lower level of miR146 was correlated with an increase of aGVHD risk [abs odd ratio (OR)=0.457  $p=0.045$  Figure 1A]. In addition, lower level of miR146 was also correlated with moderate aGVHD (grade2) [abs OR=0.308  $p=0.015$  and delta OR=0.519  $p=0.05$ , respectively Figure 1B], while increased level of miR100 and miR155 were correlated with severe aGVHD (grade 3-4) [abs OR=29.22  $p=0.007$  and OR=2.44  $p=0.016$  Figure 1C-D].

**Conclusions:** This study confirms our previous findings that miR100 and miR155 EVs content and the risk of aGVHD are significantly associated. Moreover, this prospective study also showed the significant correlation with miR146. Interestingly, miRNA100 was reported to regulate inflammatory neovascularization during GvHD, while miR146 and miR155 are both involved in the adaptive and the innate immune systems. In GVHD murine studies, miR-146a was correlated with the severity of aGVHD whereas the downregulation of miR-155 expression reduced its severity. Correlation of miRNA and EVs membrane proteins by Flow cytometry is currently ongoing.+

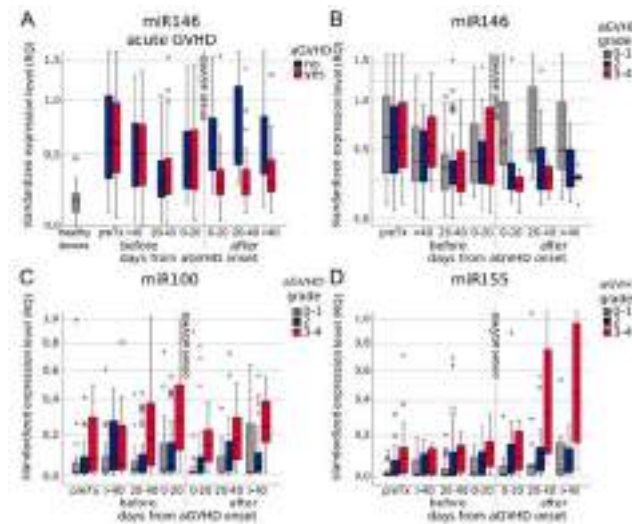

Figure 1.

## POSTERS

## Techniques in the Diagnosis and Follow-up of Hematologic Malignancies

## P01

## THE MRD IN ACUTE MYELOID LEUKEMIA: FLOW CYTOMETRY OR MOLECULAR BIOLOGY?

S. Galimberti<sup>1</sup>, V. Biso<sup>1</sup>, F. Guerrini<sup>1</sup>, V. Guerri<sup>1</sup>, P. Samurri<sup>1</sup>, M.R. Metelli<sup>1</sup>, F. Caracciolo<sup>1</sup>, G. Consani<sup>1</sup>, E. Orciuolo<sup>1</sup>, M. Pelosini<sup>1</sup>, L. Macchia<sup>1</sup>, E. Capochiani<sup>2</sup>, A. Stefanelli<sup>2</sup>, I. Bertaglia<sup>2</sup>, F. Simonetti<sup>2</sup>, E. Benedetti<sup>1</sup>

<sup>1</sup>UO Ematologia AOUP - Dipartimento di Medicina Clinica e Sperimentale, Università di Pisa; <sup>2</sup>UO Ematologia ATNO, Italy

**Introduction:** Thanks to the sensitive and accurate available molecular techniques, the minimal/measurable residual disease (MRD) is today a reality that might lead the therapeutic project also in acute myeloid leukemia (AML). According to the ELN guidelines, the multiparametric flow cytometry might be used when at diagnosis LAIP is identified; on the other hand, the PCR for recurrent translocations and NPM1 mutations are predictive molecular tests. In absence of these markers, WT1 expression, sometimes in combination with FLT3, might be allowed. In this study we compared flow cytometry (FC) and molecular biology (PCR for NPM1, WT1 expression, FLT3-ITD) for MRD monitoring in a series of 196 AML patients, 21% at favorable, 43% at intermediate and 36% at poor ELN risk.

**Methods:** CF analyzed at least 100,000 events for identifying patient-specific LAIP using a standardized immunophenotypic panel. PCR for NPM1, WT1 expression and GeneScan PCR for FLT3-ITD mutations were performed according to the national and international guidelines. Patients received 3+7 therapy schedule or demethylating agents according to age and patient's fitness.

**Results:** At diagnosis, LAIP was identified in 30% of cases, that means that in the majority of cases FC was not informative. On the other hand, the NPM1 mutations have been identified in 45% of cases, FLT3-ITD in 29%, while 83% of patients over-expressed WT1. In 14% of cases FLT3 and NPM1 mutations co-occurred. At the end of consolidation, FC identified as MRD+ 35% of samples, whereas 65% and 44% of patients remained MRD+ when NPM1 or FLT3-ITD were used as disease marker. Overall, the number of cases recognized as MRD-positive by using WT1 or NPM1 was 2.5 times higher than that occurred when FC was employed. Considering as gold standard the NPM1 quantitative monitoring, the FC failed MRD identification in 50% of cases, FLT3-ITD in 33% and WT1 expression in 44% of cases. Moreover, when cohort of relapsed patients was considered, there was a significant predictive power for WT1 expression (that predicted relapse 1-3 months before) and the time for becoming MRD-negative in NPM1/FLT3-mutated was longer for patients who died versus those still alive.

**Conclusions:** This monocentric study showed that the molecular biology was superior to FC in terms of MRD detection because its larger applicability. In particular, the best predictive marker remained NPM1; nevertheless also WT1 resulted predictive and the concept of "early MRD-negativity achievement" seems to play a role in cases NPM1 and FLT3 mutated. About the possibility of employing NGS for MRD assessment, this technique is not sensitive enough, notwithstanding it might help to identify a possible target for further treatment.

## P02

## HEMATOLOGICAL ANOMALIES AND BIOCHEMICAL PARAMETERS IN COVID-19 INFECTION: THE EXPERIENCE OF THE TOR VERGATA UNIVERSITY HOSPITAL IN ROME

V.C. Arena<sup>1</sup>, M. Iozzo<sup>2</sup>, G. Viola<sup>2</sup>, R. Ruggia<sup>2</sup>, R. Massoud<sup>1,2</sup>, A. Copponi<sup>1,2</sup>, A. Feudjio Dongmo<sup>1,2</sup>, A. Mohamad<sup>1,2</sup>, S. Yacoub<sup>1</sup>, M. Pieri<sup>1</sup>, S. Bernardini<sup>1,2</sup>, M. Morello<sup>1,2</sup>

<sup>1</sup>Molecular Biology Department of Experimental Medicine, University of Rome Tor Vergata, Tor Vergata University Hospital (Ptv); <sup>2</sup>Hematology Section, Clinical Biochemistry and Clinical Pathology, Department of Laboratory Medicine, University of Rome Tor Vergata, Tor Vergata University Hospital (Ptv), Italy

**Introduction:** Coronavirus disease is a highly contagious disease causing significant immune dysfunction and aberrant cytokine storms contributing to severity and mortality of the disease. Although pulmonary manifestations were identified as the main symptoms, several hematological abnormalities and changes in the main inflammatory parameters were also detected. In order to contribute to the knowledge of the immunopathology of COVID-19 viral infection, we conducted, in both survivors and not survivors, an observational study aimed to evaluate the levels of inflammatory indices and identifying the morphological alterations of the blood cells involved in the immune response.

**Methods:** This observational study included 187 COVID-19 patients classified, according to outcome, in survivors (S) /non-survivors (NS) that were admitted in the Hospital Tor Vergata between October 1, 2020 to April 1, 2021. Our data included symptoms, comorbidities, severity and inflammatory biochemical laboratory parameters. Blood cells were analyzed by using SP 50 SYSMEX, that allows the stain and measure the positional separation of hematological cells. By using this instrument, it was also possible to obtain the extended inflammation parameters ("flags") such as immature granulocytes (IG, activated neutrophil) and reactive lymphocytes. In addition, a microscopic analysis of the morphological characteristics of blood cells was performed on blood smears.

**Results:** In NS, compared to S, the values of inflammatory serum markers reactive protein C (CRP) (p<0,01), interleukine 6 (IL-6) (p<0,001) and Adrenomedullin (ADM) (p<0,003) increased significantly and it was also observed an evident alteration into distribution of the different cell lines in terms of immunophenotype and positional scattergrams. In particular, the hematological and morphological examination of blood film from NS patients, compared to S patients, demonstrated: i) a marked neutrophilia and increase of neutrophils to lymphocytes ratio (NLR), that are an expression of the cytokine storm and linked to hyper-inflammatory state; ii) an increase of immature granulocytes "IG" (expression of a dysregulated myelopoiesis); iii) an increase in the CD4 / CD8 lymphocyte ratio and a significant decrease of monocytes to lymphocytes ratio (LMR). Furthermore, in neutrophils from NS, it was observed the presence of particular pathological morphological alterations such as: dysmorphic nucleus, evident azurophil granulations and cytoplasmatic vacuoles.

**Conclusions:** From our data appears that in COVID-19, the measure of classical hemato-biochemical markers implemented by an accurate evaluation of microscopic blood smear and by the analysis of scattergram, support the clinician for the prognosis and it suggests a new biological field for a possible pharmacological intervention.

## Myeloproliferative Disorders

### P03

#### AUTOANTIBODIES AGAINST TYPE I IFNS IN PATIENTS WITH PH-NEGATIVE MYELOPROLIFERATIVE NEOPLASMS

O. Borsani,<sup>1</sup> P. Bastard,<sup>2,3</sup> J. Rosain,<sup>2,3</sup> A. Gervais,<sup>2,3</sup>  
E. Sant'Antonio,<sup>4</sup> D. Vanni,<sup>1</sup> I. Casetti,<sup>1</sup> D. Pietra,<sup>5</sup> C. Trotti,<sup>1</sup>  
V. Ferretti,<sup>6</sup> L. Malcovati,<sup>1,5</sup> L. Arcaini,<sup>1,5</sup> A. Borghesi,<sup>7</sup>  
J. Casanova,<sup>2,3,8,9</sup> E. Rumi<sup>1,5</sup>

<sup>1</sup>Department of Molecular Medicine, University of Pavia; <sup>2</sup>Laboratory of Human Genetics of Infectious Diseases, Necker Branch, INSERM U1163, Necker Hospital for Sick Children; <sup>3</sup>University of Paris, Imagine Institute; <sup>4</sup>Hematology Division, University Hospital "Paolo Piaccone"; <sup>5</sup>Division of Hematology, Fondazione IRCCS Policlinico San Matteo; <sup>6</sup>Service of Clinical Epidemiology and Biometry, Fondazione IRCCS Policlinico San Matteo; <sup>7</sup>Neonatal Intensive Care Unit, Fondazione IRCCS Policlinico San Matteo; <sup>8</sup>St. Giles Laboratory of Human Genetics of Infectious Diseases, Rockefeller Branch, The Rockefeller University; <sup>9</sup>Howard Hughes Medical Institute

**Background and Aim:** It has been demonstrated that autoimmune diseases and classic Ph-negative myeloproliferative neoplasms (MPN) can co-occur, suggesting a common background of immune dysregulation. SARS-CoV-2 infection displays extreme inter-individual clinical variability, ranging from silent infection to lethal disease. At least 10% of patients with life-threatening coronavirus disease 2019 (COVID-19) have neutralizing autoantibodies (AABs) against type I IFNs (IFN-I). Here, we searched for AABs against IFN-I in a cohort of MPN patients to evaluate the prevalence of these AABs in the MPN population and to check for clinical correlations, including severity of COVID-19.

**Methods:** Plasma samples from consecutively referred MPN patients were prospectively collected between November 2020 and June 2021 and frozen at -30°C immediately after collection. Levels of AABs against IFN-I subtypes were measured using both an ELISA and a neutralization assay.

**Results:** We included a total of 219 MPN patients. Neutralizing AABs to IFN-I were detected in 29 patients (13.2%, 95%CI: 9.1% - 18.5%). Comparing patients with and without AABs we observed a significant difference in terms of distribution of MPN diagnosis ( $P = 0.029$ ) and driver mutations ( $P = 0.019$ ). Overall, 29 patients (13%) got SARS-CoV-2 infection and 8 of them (28%) required hospitalization due to severe COVID-19. AABs against IFN-I were detected in 4 of the 29 infected patients. A higher rate of hospitalization for severe COVID-19 was observed in patients with AABs (2 of 4 patients, 50%) compared to those without (6 of 25 patients, 24%) ( $P = 0.300$ ).

**Conclusions:** In this study, we detected a prevalence of AABs against IFN-I which is much higher in our MPN cohort (13%) than in the general population (2-3%). We also found a correlation between the presence of AABs and both the hematological diagnosis and the driver mutation. Despite a comparable prevalence of SARS-CoV-2 infection between MPN patients with or without AABs, we observed a different rate of hospitalization due to severe COVID-19 which is almost twice in those with AABs compared to those without these AABs. However, this difference did not reach a statistical significance, probably because of the low number of SARS-CoV-2 infection in the subgroup of patients with AABs. Thus, further studies to analyse the prevalence of AABs against IFN-I in patients with MPN, their association with other forms of auto-immunity and severe COVID-19 are warranted.

### P04

#### INHIBITION OF ERK1/2 REDUCES OPN PRODUCTION AND BONE MARROW FIBROSIS DEVELOPMENT IN A MYELOFIBROSIS MOUSE MODEL

S. Rontautoli<sup>1</sup>, E. Bianchi<sup>1</sup>, L. Tavernari<sup>1</sup>, M. Dall'Orta<sup>2</sup>, G. Grisendi<sup>3</sup>,  
M. Mirabile<sup>1</sup>, S. Sartini<sup>1</sup>, E. Genovese<sup>1</sup>, C. Carretta<sup>1</sup>, S. Mallia<sup>1</sup>,  
S. Parenti<sup>1</sup>, L. Fabbiani<sup>4</sup>, N. Bartalucci<sup>5</sup>, L. Losi<sup>6</sup>, M. Dominici<sup>3</sup>,  
A.M. Vannucchi<sup>5</sup>, R. Manfredini<sup>1</sup>

<sup>1</sup>Centre for Regenerative Medicine, Life Sciences Department, University of Modena and Reggio Emilia; <sup>2</sup>Rigenerand S.R.L.; <sup>3</sup>Division of Oncology, Laboratory of Cellular Therapy, Department of Medical and Surgical Sciences of Children & Adults, University of Modena and Reggio Emilia; <sup>4</sup>Department of Medical and Surgical Sciences of Children & Adults, Pathology Unit, University of Modena and Reggio Emilia; <sup>5</sup>Department of Experimental and Clinical Medicine, and Center Research and Innovation of Myeloproliferative Neoplasms (CRIMM), University of Florence, Careggi University Hospital; <sup>6</sup>Department of Life Sciences, Pathology Unit, University of Modena and Reggio Emilia

**Introduction:** Myelofibrosis (MF) is a Philadelphia-negative myeloproliferative neoplasm characterized by the abnormal release of profibrotic and proinflammatory mediators by neoplastic cells that fosters the development of bone marrow (BM) fibrosis. None of the genomic lesions described in patients account for all the features of MF pathogenesis, especially the BM fibrosis can be late and only partially recapitulated in MPN mouse models such as JAK2V617F-knockin mice. In addition, currently available treatments do not reverse BM fibrosis in patients. Therefore, elucidating the mechanisms that lead to fibrosis development is essential for the identification of novel druggable targets that might improve current therapies. Recently, we unveiled that the overproduction of osteopontin (OPN) by malignant hematopoietic cells contributes to the development of BM fibrosis in MF patients. Notably, MF patients display increased plasmatic concentration of OPN, and higher OPN plasma levels correlate with a more severe grade of BM fibrosis and a shorter overall survival. Here, we aim to assess whether OPN is a druggable target to dampen the development of BM fibrosis.

**Methods:** The activity of inhibitors of signaling pathways affecting the expression of OPN (e.g. NF- $\kappa$ B, ERK1/2, MEK1/2 inhibitors) was evaluated *in vitro* in human primary monocytes, given their key role in OPN secretion. The effects on cell viability were assessed by XTT assay at 72 hours of treatment, while OPN expression and production were evaluated by qRT-PCR and ELISA, respectively, at 72 and 96 hours of treatment. Inhibitors of OPN production selected from the *in vitro* screening were assessed *in vivo* for their effect on OPN plasma levels, together with the development of thrombocytosis, splenomegaly and BM and spleen fibrosis, in a MF mouse model induced by the treatment with a thrombopoietin (TPO) mimetic.

**Results:** The *in vitro* screening allowed us to identify drug inhibitors of ERK1/2 (Ulixertinib), MEK1/2 (Cobimetinib), p38 (VX-745) and a Ca<sup>2+</sup> channel antagonist (Verapamil) that can remarkably reduce OPN expression and production with negligible effects on cell viability. Next, we evaluated their effect in TPO mimetic treated mice, a MF mouse model that was selected since it develops BM and spleen fibrosis in a short time frame compared with other available disease models. We found that MEK1/2 or ERK1/2 inhibitors did not significantly affect the development of thrombocytosis and splenomegaly, while the treatment with the ERK1/2 inhibitor Ulixertinib was able to constrain the increase of OPN plasma levels and strongly reduced the development of BM and spleen fibrosis in TPO mimetic treated mice.

**Conclusions:** Our data demonstrate that the ERK1/2 inhibitor Ulixertinib can counteract the overproduction of OPN and the development of BM fibrosis in MF mouse model and pave the way for its clinical application as an innovative therapy in combination with JAK inhibitors.

### P05

#### THE DIFFERENT RESPONSE TO OXIDATIVE DAMAGE BETWEEN JAK2 AND CALR-MUTATED PATIENTS CORRELATES WITH CLINICAL OUTCOME IN MYELOFIBROSIS

E. Genovese<sup>1</sup>, M. Mirabile<sup>1</sup>, S. Rontautoli<sup>1</sup>, S. Sartini<sup>1</sup>, S. Fantini<sup>1</sup>,  
L. Tavernari<sup>1</sup>, M. Maccaferri<sup>2</sup>, P. Guglielmelli<sup>3</sup>, E. Bianchi<sup>1</sup>,  
S. Parenti<sup>1</sup>, C. Carretta<sup>1</sup>, S. Mallia<sup>1</sup>, S. Castellano<sup>4,5,6</sup>, C. Colasante<sup>5</sup>,  
M. Balliu<sup>3</sup>, N. Bartalucci<sup>3</sup>, R. Palmieri<sup>7</sup>, T. Ottone<sup>7,8</sup>, B. Mora<sup>9</sup>,  
L. Potenza<sup>5</sup>, F. Passamonti<sup>9</sup>, M.T. Voso<sup>7,8</sup>, E. Tagliafico<sup>4,5</sup>, M. Luppi<sup>5</sup>,  
A.M. Vannucchi<sup>3</sup>, R. Manfredini<sup>1</sup>

<sup>1</sup>Life Sciences Department, University of Modena and Reggio Emilia, Centre for Regenerative Medicine; <sup>2</sup>Department of Laboratory Medicine and Pathology, Diagnostic Hematology and Clinical

Genomics, AUSL/AOU Policlinico; <sup>3</sup>Department of Experimental and Clinical Medicine, and Center Research and Innovation of Myeloproliferative Neoplasms (CRIMM), University of Florence, Careggi University Hospital; <sup>4</sup>Center for Genome Research, University of Modena and Reggio Emilia; <sup>5</sup>Department of Medical and Surgical Sciences, University of Modena and Reggio Emilia, AUSL/AOU Policlinico; <sup>6</sup>PhD program in Clinical and Experimental Medicine, University of Modena and Reggio Emilia; <sup>7</sup>Department of Biomedicine and Prevention, University of Tor Vergata; <sup>8</sup>Santa Lucia Foundation, I.R.C.C.S., Neuro-Oncohematology; <sup>9</sup>Division of Hematology, Ospedale ASST Sette Laghi, University of Insubria

**Introduction:** Myelofibrosis (MF) is the Philadelphia-negative myeloproliferative neoplasm characterized by the worst prognosis and no response to conventional therapy. Driver mutations in JAK2 and CALR impact on JAK-STAT pathway activation but also on the production of reactive oxygen species (ROS). ROS play a pivotal role in inflammation-induced oxidative damage to cellular components including DNA, therefore leading to genomic instability and promoting cell transformation. In order to unveil the role of driver mutations in oxidative stress, we assessed oxidative stress levels in CD34+ cells and plasma samples from myelofibrosis patients.

**Methods:** As a first, we have measured the levels of ROS, 8-OHdG and SOD in CD34+ cells from 20 JAK2 and 14 CALR myelofibrosis (MF) patients compared with 17 healthy donors (HD). In particular, the redox-sensitive CM-H2DCFDA was used to measure the intracellular ROS. SOD activity was measured by means of colorimetric assay. Moreover, levels of 8-OHdG were detected by enzyme-linked immunosorbent assay (ELISA). Subsequently, we evaluated whether this different oxidative status is also detectable in 100 plasma samples of MF patients, as the level of total antioxidant capacity (TAC), an analyte frequently used to assess the antioxidant status of biological samples. Finally, we evaluated the association between TAC plasma levels and overall survival (OS).

**Results:** Our results demonstrated that ROS production in CD34+ cells from CALR mutated patients is strongly increased when compared with those from JAK2 mutated patients, leading to increased oxidative DNA damage. Moreover, CALR-mutant cells show less activity of the antioxidant enzyme superoxide dismutase (SOD) than JAK2 mutated ones. Strikingly, we observed that high plasma levels of total antioxidant capacity (TAC) correlate with detrimental clinical features, such as high levels of lactate dehydrogenase (LDH) and circulating CD34+ cells. The increase of TAC levels observed in plasma of JAK2-mutant patients are also associated with a poor overall-survival. This suggests the idea that high levels of TAC counteract a dramatic increase in oxidative stress, leading to the progression of the disease.

**Conclusion:** In summary, our results demonstrated that CALR mutation has a higher impact than JAK2 mutation on the oxidative stress status in CD34+ MF cells. Taken together, our data suggest that different capability to respond to oxidative stress could be one of the mechanisms underlying disease progression of myelofibrosis.

## P06

### PERIPHERAL BLOOD CYTOTOXIC T CELLS FROM MYELOFIBROSIS PATIENTS SHOW EARLY EXHAUSTED FEATURES

L. Tavernari<sup>1</sup>, S. Rontauroli<sup>1</sup>, M. Maccaferri<sup>2</sup>, B. Mora<sup>3</sup>, E. Bianchi<sup>1</sup>, S. Parenti<sup>1</sup>, E. Genovese<sup>1</sup>, P. Guglielmelli<sup>4</sup>, C. Carretta<sup>1</sup>, S. Mallia<sup>1</sup>, M. Mirabile<sup>1</sup>, S. Sartini<sup>1</sup>, C. Colasante<sup>5</sup>, L. Potenza<sup>5</sup>, F. Passamonti<sup>3</sup>, E. Tagliafico<sup>5,6</sup>, M. Luppi<sup>5</sup>, A.M. Vannucchi<sup>4</sup>, R. Manfredini<sup>1</sup>

<sup>1</sup>Centre for Regenerative Medicine, Life Sciences Department, University of Modena and Reggio Emilia; <sup>2</sup>Department of Laboratory Medicine and Pathology, Diagnostic Hematology and Clinical Genomics, AUSL/AOU Policlinico; <sup>3</sup>Division of Hematology, Ospedale ASST Sette Laghi, University of Insubria; <sup>4</sup>Department of Experimental and Clinical Medicine, and Center Research and Innovation of Myeloproliferative Neoplasms (CRIMM), University of Florence, Careggi University Hospital; <sup>5</sup>Department of Medical and Surgical Sciences, University of Modena and Reggio Emilia, AOU Policlinico; <sup>6</sup>Center

for Genome Research, University of Modena and Reggio Emilia, Italy

**Introduction:** Primary myelofibrosis (PMF) is a myeloproliferative neoplasm (MPN) characterized by megakaryocyte hyperplasia, bone marrow fibrosis and extramedullary haematopoiesis. Compelling evidence are suggesting that persistent antigen stimulation in the tumour microenvironment can differentiate T effector cells into terminally exhausted T cells, a functional state characterized by decrease in proliferation, cytotoxicity and cytokine production. Cutting-edge therapies are focused on the reversion of exhausted state through immune checkpoint inhibition to recover the immune response against the tumour. Despite MPNs are myeloid neoplasms, T cells are showing dysfunctional features too, thus we investigated T cell exhaustion in PMF to assess the possibilities of immune checkpoint inhibition as a new effective therapy in combination with those already in use.

**Methods:** We isolated peripheral blood mononuclear cells (PBMCs) from 36 MF patients and 18 healthy donors (HD), characterized by flow cytometry CD3+CD8+ T cells by assessing the expression profile of the following inhibitory receptors: PD1, CD244, CD160, TIM3, LAG3, CTLA4. Results were correlated with clinical features as Dynamic International Prognostic Scoring System (DIPSS) classification, splenomegaly, haemoglobin level and other negative prognostic factors. For T cell activation assays we stimulated PBMCs overnight in the presence of coated anti-CD3, anti-CD28 and Brefeldin A, whilst cytokine production was then assessed by intracellular flow cytometry staining. Chi square and Mann Whitney test were used for statistical analysis.

**Results:** We reported increased expressions of PD1, CD244 and CD160 on CD3+CD8+ T cells from MF patients together with the expansion of PD1+CD244+, PD1+CD160+, PD1+CD57- cytotoxic T cell populations. The PD1+CD57- population also showed increased expression of all the inhibitory receptors assessed. Furthermore, we observed reduced production of IFN $\gamma$ , TNF $\alpha$  and Granzyme B from CD3+CD8+ T cells of MF patients. Correlation of PD1 expression on cytotoxic T cells with clinical features of the patients showed that higher levels of PD1 correlates with splenomegaly, low haemoglobin levels, transfusion dependency and more severe DIPSS classification. Furthermore, CD244 expression on cytotoxic T cells correlates with low haemoglobin levels, and white blood cell count greater than 25\*10<sup>9</sup>/L while CD160 expression correlates with splenomegaly.

**Conclusions:** Our data evidenced in PMF patients the presence of an impaired population of peripheral blood cytotoxic PD1+CD57- T cells expressing multiple inhibitory receptors and with reduced cytokine production after *in vitro* activation. Moreover, clinical correlations suggest a more severe disease in patients with higher PD1, CD244 and CD160 expression on cytotoxic T cells. Taken together this data highlights an early exhausted state likely implicated in immune escape which will be investigated for immune checkpoint inhibition.

## P07

### IDH2 MUTATIONS IN MYELOFIBROSIS: IDENTIFICATION BY “DROP-OFF” DIGITAL DROPLET PCR

S. Grassi\*<sup>1</sup>, F. Guerrini\*<sup>1</sup>, S. Balducci<sup>1</sup>, G. Della Nera<sup>1</sup>, F. Ricci<sup>1</sup>, C. Baratè<sup>2</sup>, S. Galimberti<sup>1</sup>

<sup>1</sup>Dipartimento di Medicina Clinica e Sperimentale, Sezione Ematologia, Università di Pisa; <sup>2</sup>UO Ematologia, AOU, Italy

**Introduction:** After availability of the isocitrate dehydrogenase 1 and 2 (IDH1 and IDH2) inhibitors, the screening of these mutations became fundamental, especially in acute myeloid leukemia. Recently, these mutations have been found also in 2-5% of the chronic myeloproliferative neoplasias (MPNs), where they seem to accelerate the transition to myelofibrosis (MF). Usually IDH1 and IDH2 mutations are assessed by Sanger or deeper sequencing techniques, such as NGS; nevertheless, the sensitivity of these techniques ranges from 15% to 1%. Newer molecular assays with deeper sensitivity are today available, such as digital PCR (dd-PCR). In this work we assessed by an innovative dd-PCR method the prevalence of IDH2 mutations in a series of 27 patients with MF and compared their occurrence with that already reported in literature.

**Methods:** The “drop-off” ddPCR FAM/HEX Assay (Biorad®, Milan,

Italy) was adopted and best amplification conditions set (20 ng of DNA, primers annealing temperature 56°C, balanced probes concentrations for R140, excess of HEX for R172). The technique requires a single pair of probes to detect and quantify in a single reaction different mutations at a specific residue: the FAM-labeled probe binds a reference sequence distant from the target but within the same amplicon, while the HEX probe binds the wild-type sequence in the target site. Thus, wild-type samples present signals from both FAM and HEX probes, while the mutated ones display only the FAM signal.

**Results:** The newly set method reached a sensitivity of  $1 \times 10^{-3}$ , really higher than that of Sanger and NGS. Specificity was determined using “GeneArt Strings DNA Fragments” (ThermoFisher, Waltham, Massachusetts, USA), linear dsDNA fragments representing the positive controls for specific point mutations (R140W, R140L, R140Q, R140G and R172W, R172G, R172S, R172M, R172K). By screening IDH2 mutations in 27 patients affected by MF (primitive or post-ET) we identified 4/27 (15%) cases as IDH2-mutated, 3 in R140 and 1 in R172. Three patients had co-mutation with JAK2V617F and were treated with Ruxolitinib, while the other one was mutated in CALR gene and received hydroxyurea. The median OS of the entire series was 120 months, comparable with our previous data; notwithstanding the small number of enrolled cases, the IDH2-mutated patients more frequently showed disease-related symptoms, but also lower LDH and higher hemoglobin levels.

**Conclusions:** the study showed that ddPCR is useful for identifying patients carrying IDH2 mutations; indeed, this technique is simple to be performed, with acceptable costs and reaching a satisfying sensitivity. This method allowed to identify mutation of IDH2 in a higher number of patients compared to the gold standard **Methods:** Further studies will confirm the prognostic role of the IDH2 mutations in MF and will show if enasidenib might represent a promising drug to be combined with JAK inhibitors.

## P08

### LACTATE ORCHESTRATES TUMOR MICROENVIRONMENT REMODELING AND REWIRES METABOLIC PROFILE IN MYELOFIBROSIS

D. Tibullo<sup>1</sup>, M. Spampinato<sup>1</sup>, C. Giallongo<sup>2</sup>, E. La Spina<sup>3</sup>, L. Longhitano<sup>1</sup>, A. Romano<sup>3</sup>, I. Dulcamare<sup>3</sup>, A. Barbato<sup>3</sup>, G. Scandura<sup>3</sup>, A.M. Amorini<sup>1</sup>, G. Lazzarino<sup>1</sup>, T. Zuppelli<sup>2</sup>, R. Caltabiano<sup>2</sup>, G. Li Volti<sup>1</sup>, F. Di Raimondo<sup>3</sup>, G.A. Palumbo<sup>2</sup>

<sup>1</sup>Department of Biomedical and Biotechnological Sciences, Section of Biochemistry, University of Catania, Catania; <sup>2</sup>Department of Medical, Surgical Sciences and Advanced Technologies G.F. Ingrassia, A.O.U. “Policlinico-Vittorio Emanuele”, University of Catania, Catania; <sup>3</sup>Department of General Surgery and Medical-Surgical Specialties, Division of Hematology, A.O.U. “Policlinico-Vittorio Emanuele”, University of Catania, Catania, Italy

**Introduction:** Primary Myelofibrosis (PMF) is a myeloproliferative neoplasm characterized by ineffective clonal hematopoiesis, splenomegaly and bone marrow (BM) fibrosis. Since alteration of hematopoiesis is constantly associated with profound modifications of the bone marrow, we hypothesize that CD34+ cells from PMF can actively produce lactate rewiring metabolism of immune cells and mesenchymal stromal cells (MSCs) which could favor immune evasion and remodeling of BM niche.

**Methods:** Cell proliferation was assessed *in vitro* on primary MSCs and HS-5 cell line. Protein expression was performed by western blot and immunofluorescences assay. The NCBI GEO database was also used to select transcriptome datasets to analyze gene expression in PMF patients. Cytokine detections were performed by Multiplex immunobead assay technology *in vitro* and in patient-derived sera. Results were confirmed in adult zebrafish PMF model.

**Results:** CD34+ cells from PMF patients significantly upregulated the lactate transporters monocarboxylate transporters (MCT-1 and -4) compared to healthy CD34+ cells. Consistently, lactate concentration was higher in PMF sera compared to healthy controls. Since PMF patients showed increased percentage of circulating immunosuppressive cells such as granulocytic and monocytic MDSC and Treg, we incubated

healthy peripheral blood mononucleated cells (PBMNCs) with PMF sera in presence or absence of an inhibitor of MCT1 (AZD3965), the transporter which regulates lactate import. Incubation with PMF sera favored expansion of Treg and M-MDSCs. The effect was reverted by the addition of AZD3965. In order to study the effect of lactate in BM remodeling, we treated *in vitro* healthy MSCs with lactate (20 mM) for 24h. Interestingly, lactate induced a modification of extracellular matrix organization as demonstrated by an increase of reticulin and collagen deposition and increase of metalloproteases (MMP9, MMP2). Moreover, lactate increased calcium deposit and soluble osteogenic molecular signals (*i.e.* osteoprotegerin, osteonectin). These results also were obtained after incubation with PMF sera and were reverted after AZD3965 treatment. Since it has been demonstrated the role of cancer-associated fibroblast (CAF) in cancer development through ECM remodeling, we next evaluated the expression of CAF markers in MSCs after lactate exposure.  $\alpha$ -SMA, FAP1 and TGF $\beta$  was found upregulated. The effect was reverted by AZD3965. Finally, we further confirmed these results in a Zebrafish animal model of PMF.

**Conclusions:** Inhibition of lactate metabolism may represent a strategy to inhibit invasive and metastatic phenotype of cancer cells and contribute to restore the anti-cancer immune response. Therefore, lactate metabolism may represent a promising target to counteract inflammation, osteosclerosis and fibrosis in PMF patients.

## P09

### IGFBP-6/SONIC HEDGEHOG/TLR4 SIGNALING AXIS DRIVES BONE MARROW FIBROTIC TRANSFORMATION IN PRIMARY MYELOFIBROSIS

L. Longhitano<sup>1</sup>, D. Tibullo<sup>1</sup>, N. Vicario<sup>1</sup>, C. Giallongo<sup>2</sup>, E. La Spina<sup>3</sup>, A. Romano<sup>3</sup>, S. Lombardo<sup>4</sup>, M. Moretti<sup>5</sup>, F. Masia<sup>5</sup>, A.R.D. Coda<sup>6</sup>, S. Venuto<sup>6</sup>, P. Fontana<sup>4</sup>, R. Parenti<sup>1</sup>, G. Li Volti<sup>1</sup>, M. Di Rosa<sup>1</sup>, G.A. Palumbo<sup>2</sup>, A. Liso<sup>6</sup>

<sup>1</sup>Department of Biomedical and Biotechnological Sciences, University of Catania; <sup>2</sup>Department of Scienze Mediche Chirurgiche e Tecnologie Avanzate “G.F. Ingrassia”, University of Catania; <sup>3</sup>Division of Hematology, Department of General Surgery and Medical-Surgical Specialties, A.O.U. “Policlinico-Vittorio Emanuele”, University of Catania; <sup>4</sup>IOM Ricerca Srl; <sup>5</sup>Department of Medicine, University of Perugia; <sup>6</sup>Department of Medical and Surgical Sciences, University of Foggia, Italy

**Introduction:** Primary myelofibrosis (PMF) is a Ph-negative chronic myeloproliferative neoplasm characterized by bone marrow fibrosis associated with bone marrow microenvironment alterations, mostly driven by the activation of the cytokine receptor/JAK2 pathway. Understanding the clear molecular cut underlying this pathology is now necessary to improve the clinical outcome of patients. An increasing number of studies point towards an important involvement of the mesenchymal stem cells niche in the pathophysiology of PMF. The present study aims to investigate the involvement of insulin-like growth factor-binding proteins 6 (IGFBP-6)/sonic hedgehog /Toll-like receptor 4 axis in the microenvironment alterations of primary myelofibrosis.

**Methods:** Cell proliferation, migration and clonogenicity assay were performed *in vitro* on primary cells and human mesenchymal stem cell lines. Protein expression was performed by western blot and immunofluorescences assay. The NCBI Gene Expression Omnibus (GEO) database was used to analyze genes expression in PMF transcriptome datasets. Cytokines and IGFBP6 detection were performed by Multiplex immunobead assay technology *in vitro* and in patient-derived sera.

**Results:** IGFBP6 was more expressed in CD34+ cells from PMF patients, and its level was increased in PB serum. We hypothesized that IGFBP6 release by tumor cells could modify the human mesenchymal stem cells phenotype contributing to BM fibrosis. Healthy mesenchymal stem cells treated with recombinant IGFBP6 showed a significant increase of  $\alpha$ -SMA, FAP1 and TGF- $\beta$  protein expression, promoting a Cancer-associated fibroblasts phenotype. Quantitative multiplex assay showed that IGFBP6 induced a significant increase of osteogenic differentiation and inflammations. Interestingly, we observed that IGFBP6



shaped the microenvironment towards a pro-tumoral phenotype by activation of the sonic hedgehog (SHH) signaling pathway. Furthermore, TLR4 signaling was also activated after IGFBP6 and SHH exposure and reverted by cyclophamide exposure, an inhibitor of the SHH pathway, confirming that SHH is involved in TLR4 activation and in microenvironment alterations orchestrated by IGFBP6.

**Conclusions:** Our results suggest that the IGFBP-6/SHH/TLR4 axis is implicated in alterations of the primary myelofibrosis microenvironment and that IGFBP-6 may play a central role in activating SHH pathway during the development of the fibrotic process.

## Chronic Myeloid Leukemia

### P10

#### IN ADVANCED PHASE CML, THE SETD2 HISTONE METHYLTRANSFERASE SHOWS TUMOR SUPPRESSOR FUNCTIONS AND IS RESPONSIBLE FOR BCR-ABL1-INDEPENDENT GENOMIC INSTABILITY

S. De Santis<sup>1\*</sup>, M. Mancini<sup>2</sup>, C. Monaldi<sup>1</sup>, S. Bruno<sup>1</sup>, F. Castagnetti<sup>1,2</sup>, G. Gugliotta<sup>2</sup>, G. Rosti<sup>2</sup>, A. Iurlo<sup>3</sup>, E. Abruzzese<sup>4</sup>, M. Cerrano<sup>5</sup>, M. Bonifacio<sup>6</sup>, S. Galimberti<sup>7</sup>, S. Balducci<sup>7</sup>, F. Stagno<sup>8</sup>, M. Baccarani<sup>1</sup>, M. Cavo<sup>1,2</sup>, S. Soverini<sup>1</sup>

<sup>1</sup>Department of Experimental Diagnostic and Specialty Medicine - DIMES, Institute of Hematology "L. e A. Seràgnoli", University of Bologna, Bologna; <sup>2</sup>IRCCS Azienda Ospedaliero-Universitaria di Bologna, Istituto di Ematologia "Seràgnoli", Bologna, Italy; <sup>3</sup>U.O. Ematologia 1 - Centro Trapianti di Midollo Ospedale Maggiore, Milano; <sup>4</sup>Divisione di Ematologia, Osp. Sant'Eugenio - Roma, Roma; <sup>5</sup>SCDO Ematologia II - AOUS San Giovanni Battista di Torino (Molinette), Torino; <sup>6</sup>Azienda Ospedaliera Universitaria Integrata, Verona; <sup>7</sup>UO Ematologia - AOU Pisana, Pisa; <sup>8</sup>Ematologia Universitaria e Trapianto Midollo Osseo, Ospedale Gaspare Rodolico, Italy

**Introduction:** Genetic/genomic instability is a hallmark of CML. SETD2, a histone methyltransferase that trimethylates histone H3 on K36 (H3K36me3), has recently demonstrated a crucial role in preserving genomic integrity by modulating DNA Mismatch Repair (MMR) and Homologous Recombination (HR) repair. By Western blotting (WB), we previously observed BCR-ABL1-independent SETD2 and H3K36me3 loss (resulting from aberrant SETD2 turnover) in 85% of blast crisis (BC) CML patients but not in newly diagnosed chronic phase (CP) patients who will achieve optimal responses.

**Methods:** SETD2-proficient (LAMA84) and -deficient (KCL22) CML cell lines and primary patient samples (n=86) were studied. Protein expression was assessed by Western blotting (WB). SETD2 transfection was done by using the Lonza Nucleofector 2b. Briefly, 106 KCL22 cells were suspended in 85 µl of cell line Nucleofector Solution V and 2 µg of a SETD2 (GFP-tagged) construct were added. The cells were subjected to nucleofection using the Lonza Amaxa Cell Line Nucleofector Kit V according to manufacturer's instructions. Reporter gene (GFP) expression was measured using flow cytometry 24 and 48 hours post transfection, and SETD2 expression and activation were confirmed by WB. Clonogenic capacity was evaluated by clonogenic assays. Cell cycle distribution was evaluated on 5×10<sup>5</sup> cells, treated with 1 µg/µL propidium iodide (PI) and RNase (both from Sigma) at 37°C for 30 min. PI uptake was measured by mean of a FACScan flow cytometer and Diva software was used to analyse results.

**Results:** To investigate whether SETD2/H3K36me3 loss impinges on the activation and proficiency of HR, we used UV rays to induce DNA damage in SETD2 siRNA-depleted LAMA 84 (SETD2-proficient) cells. Compared to control cells, cells silenced for SETD2 displayed a marked increase in γH2AX (a marker of DNA damage) and fewer RAD51 foci (markers of ongoing HR). Assessment of MMR proficiency is ongoing. To further confirm the role of SETD2 as a tumor suppressor implicated in maintaining genomic stability in CML, we transfected KCL22 (SETD2-deficient) cells with an ectopic SETD2 plasmid. Our results showed that SETD2 forced expression induced more than 50% reduction in cell doubling time, an accumulation of cells at G1/S checkpoint and a significant reduction in clonogenic potential. Moreover, SETD2 overexpression was able to restore DNA damage response, as demonstrated by WB and immunofluorescence detection of H2AX phosphorylation, RAD51 (HR) and MSH6 (MMR) observed after UV exposure.

**Conclusions:** Loss of SETD2/H3K36me3 is a novel, BCR-ABL1-independent mechanism of genetic instability in BC CML. Loss of SETD2/H3K36Me3 is associated with increased DNA damage and impaired HR repair, while its overexpression restores cell proliferation control and DNA damage repair.

Supported by AIRC IG 2019 grant (23001) and Italian Ministry of Health, "Bando Ricerca Finalizzata 2016", project GR-2016-02364880.

## P11

**IGGK MULTIPLE MYELOMA AND CHRONIC MYELOID LEUKEMIA IN A SINGLE PATIENT: A CASE REPORT AND LITERATURE REVIEW**

V. Carluccio, C. Buquicchio, G. De Santis, C.R. Germano, M. Leo, G. Lerario, S. Mallano, R. Miccolis, T.M. Santeramo, D. Loconte, G. Tarantini

*Ospedale Monsignor Dimiccoli, Italy*

**Introduction:** Coexistence of MM and CML is rare, with only 25 reported cases: MM and CML were diagnosed simultaneously in 9 cases, and sequentially in the remaining cases, with MM diagnosed first in 9 cases and CML first in 7 cases.

**Methods:** A 75-year-old woman presented to our hospital in April 2021 for leukocytosis and anemia. A complete blood count showed a WBC count of  $198 \times 10^9/L$  (85% neutrophils), Hb 8.3 g/dL, MCV 92 fl, platelet counts of  $127 \times 10^9/L$ . Blood chemistry showed total protein of 7.8 g/dL, albumin 3.1 g/dL, creatinine 0.89 mg/dl, calcium 9.2 mg/dL and monoclonal gammopathy IgG K type of 2,12 g/dl. The FLC ratio was 17.95,  $\beta_2$  microglobulin 4 mg/L, LDH 1857 U/l and urinary monoclonal protein was 223,9 mg/24 h (K chain+ complete monoclonal component). Radiological investigation revealed 13 cm spleen size and multiple osteolytic lesions in the axial skeleton, sternum and pelvis; PET-CT showed a sacral hypodense lesion and increased uptake in the L4 vertebra (SUV 5). Bone marrow biopsy showed increased cellularity with myeloid hyperplasia; IIC demonstrated CD138+ monoclonal kappa plasma cells accounting for > 10% cellularity. RT-PCR revealed BCR/ABL rearrangement (p210). Conventional cytogenetic analysis proved a 46,XX t(9;22) karyotype in 20 metaphases; FISH panel was characterized by 1q21/CKS1B in 85% of cells and monosomy 13 in 67%. Consequently, the patient was diagnosed with stage II ISS MM and high-risk Sokal CML. Considering the patient's age and hyperleukocytosis, she was first treated for CML: cytoreductive treatment was started with hydroxyurea, than with Imatinib 400 mg/d. Therefore we started treatment for MM with Bortezomib-Dexamethasone weekly and Zoledronic acid monthly. Molecular response at 3 and 6 months was MR 2, while a PR (CM 0,9 g/dl) has been achieved after V cycle of BD.

**Results:** The occurrence of CML and MM together is very rare; a possible explanation is that a pluripotent progenitor stem cell gives rise to both MM and CML cells. Another theory is that the second disease might be a therapy-related malignancy, as it occurs in patients who received alkylating agents such as Melphalan or Cyclophosphamide for MM; whereas there is no clear evidence that Lenalidomide is carcinogenic. The role of Imatinib in promoting development of MM is debatable; it may be worthwhile to monitor serum electrophoresis and protein levels during treatment.

**Conclusions:** We can conclude that simultaneous treatment with proteasome inhibitors and tyrosine kinase inhibitors may be compatible; since CYP3A4 is important for metabolism of both drugs, administration of Bortezomib as weekly instead of twice weekly may help to reduce adverse effects. Thalidomide was preferred over the Lenalidomide because of increased risk of pancytopenia with concurrent use of Imatinib and Lenalidomide. Bisphosphonates, supportive treatment in MM, have also been shown to induce apoptosis in CML cells synergistically with Imatinib through the inhibition of Ras pathway

**Myelodysplastic Syndromes**

## P12

**REVEALING TRANSCRIPTOME DEREGLATION IN HIGHER RISK MYELODYSPLASTIC SYNDROMES BEARING MUTATION IN DNMT3A GENE**

E. Galossi<sup>1</sup>, G. Falconi<sup>1</sup>, H. Hajrullaj<sup>1</sup>, A. Cristiano<sup>1</sup>, R. Palmieri<sup>1</sup>, A. Pirola<sup>2</sup>, E. Fabiani<sup>1</sup>, L. Maurillo<sup>1</sup>, R. Piazza<sup>3</sup>, M.T. Voso<sup>1</sup>

<sup>1</sup>Department of Biomedicine and Prevention, Tor Vergata University; <sup>2</sup>GalSeq s.r.l.; <sup>3</sup>Dept. of Medicine and Surgery, University of Milano - Bicocca, Italy

**Introduction:** Myelodysplastic syndromes (MDS) are heterogeneous disorders of the hematopoietic stem cell caused by genetic alterations, deregulated gene expression, and epigenetic modifications of genes, leading to inefficient hematopoiesis and a propensity to transform to acute myeloid leukemia. Although, the hypomethylating agent 5-azacitidine (AZA) is the gold standard therapy for higher-risk (HR)-MDS, the overall response rate is below 50%. The identification of molecular markers of AZA response is a challenge. We have recently reported that DNMT3A mutations, accounting for 20% of our cohort of HR-MDS, are associated to a trend of non-response to AZA treatment (p=0.051). Moreover, we showed that all patient carriers of the hotspot DNMT3A-R882 mutation (accounting for 50% of all DNMT3A mutations) were resistant to AZA (p = 0.0126). In the pursuit to understand the role of DNMT3A mutation in response to AZA treatment, we performed a transcriptomic analysis, on a well-characterized cohort of HR-MDS patients, at the time of diagnosis.

**Methods:** Our study cohort includes 12 patients with HR-MDS selected according to mutational profile of the DNMT3A gene. In particular, 7 DNMT3A mut (hotspot R882 n=3, other codons n=4) patients and 5 patients wild type (WT) for DNMT3A gene were studied, using 5 healthy donors (HD) as control. Differential gene expression was studied using RNA-sequencing of bone marrow mononuclear cells (BM-MNC). Only differentially expressed genes (DEGs) with a  $\text{padj} \leq 0.05$  and  $\log_2\text{FC} \geq |2|$  were considered.

**Results:** We first analyzed the expression profiling of BM-MNC from HR-MDS patients bearing mutations in DNMT3A gene, compared to HD. We identified a total of 392 DEGs, including 147 downregulated and 245 upregulated genes. KEGG analysis showed the presence of 28 enriched pathways. Among upregulated genes, GSEA identified enriched gene sets belonging to pathways of TNF, TGF $\beta$ , and WNT- $\beta$  catenin signaling. Interestingly, 3 out of top 25 upregulated DEGs are HOX genes, known to be involved in leukemogenesis process. Moreover, to identify an expression profile typical of DNMT3A mut MDS, we compared RNA-seq data between patients DNMT3A mut versus DNMT3A WT samples. This analysis greatly reduced the numbers of DEGs identified (n=28), compared to the previous analysis. However, using the Venn diagram, we identified 12 DEGs in common among DNMT3A mut vs DNMT3A WT and DNMT3A mut MDS vs HD. Finally, given that all R882 mut patients were unresponsive to azacitidine, we focused our attention on the expression profile of patients DNMT3A mut according to their genetic localization (R882 n= 3 vs others n=4). Of note, only 24 DEGs were deregulated in DNMT3A-R882 vs DNMT3A AnonR882.

**Conclusions:** Despite the limited number of patients analyzed, we identified a transcriptomic signature characteristic of DNMT3A mut patients (codon R882), that may help to better understand their resistance to AZA treatment. We are now validating these data on a larger MDS patient cohort.

## P13

## INTEGRATED EPIGENOMIC AND METABOLIC REPROGRAMMING BY MACROH2A1 IN MICROENVIRONMENT OF MYELODYSPLASTIC SYNDROMES (MDS)

C. Giallongo<sup>1</sup>, I. Dulcamare<sup>2</sup>, D. Tibullo<sup>3</sup>, D. Pieragostino<sup>4</sup>, M.C. Cufaro<sup>4</sup>, M.A. Amorini<sup>3</sup>, G. Lazzarino<sup>5</sup>, A. Romano<sup>2</sup>, G. Scandura<sup>2</sup>, A. Barbato<sup>2</sup>, E. La Spina<sup>2</sup>, D. Cambria<sup>2</sup>, T. Zuppelli<sup>2</sup>, A. Duminuco<sup>2</sup>, F. Di Raimondo<sup>2</sup>, G.A. Palumbo<sup>1</sup>

<sup>1</sup>Department of Medical, Surgical Sciences and Advanced Technologies "G. F. Ingrassia"; <sup>2</sup>Section of Haematology, Department of General Surgery and Medical-Surgical Specialties; <sup>3</sup>Department of Biomedical and Biotechnological Sciences; <sup>4</sup>Department of Medical, Oral and Biotechnological Sciences, University "G. d'Annunzio"; <sup>5</sup>UniCamillus—Saint Camillus International University of Health Sciences

**Background:** Mesenchymal stromal cells (MSCs) contribute to the genesis of clonal hematopoietic dysfunction in MDS. Epigenetic regulation is essential for establishing and preserving MSC self-renewal and differentiation abilities. Therefore, epigenetic dysregulations may represent good candidates for potential drug treatments. Here, we investigated the role of histone variant MacroH2A1 (mH2A1) in modulating chromatin organization and metabolic phenotype of MSCs.

**Methods:** MSCs were collected from BM of MDS patients (n=15) and matched healthy controls (n=8; HC).

**Results:** MDS-MSCs significantly upregulated mH2A1 mRNA compared to HC-MSCs. In accordance with the aberrant inflammation described in MDS microenvironment, MDS-MSCs showed higher levels of the sum of NO<sub>2</sub><sup>+</sup> and NO<sub>3</sub><sup>+</sup> associated to increased GSH and NADP<sup>+</sup>/NAPH. TLR4 also was upregulated and positively correlated to mH2A1 expression. To better investigate the relationship between mH2A1 and TLR4 in MDS-MSCs, we induced mH2A1 overexpression in HS-5 cells (mH2A1-OE) by mH2A1-CT-MYC plasmid. Our data showed that mH2A1-OE had higher expression of TLR4 and increased NFκB nuclear translocation compared to cells transfected with empty vector (CTL). Proteomic analysis confirmed upregulation of intracellular serine protease inhibitors (SerpinB2, B8, B6) strongly induced during inflammation and important for the maintenance of TLR4 activation. Moreover, proteomic approach identified upregulation of several proteins associated to hypermethylation of DNA and histones in mH2A1-OE. In particular, S-adenosylhomocysteine hydrolase which regulates the concentration of S-adenosylhomocysteine (SAH), a strong inhibitor of methyltransferase reactions and of the methyl donor S-adenosyl-methionine (SAM), resulted overexpressed. HPLC analysis showed higher SAM/SAH ratio associated to a significant reduction of SAH in mH2A1-OE, confirming the increase of the methylation index. In addition, the higher levels of CBX3, a suppressive epigenetic mark which recognizes histone H3K9me<sub>3</sub>, contributes to the maintenance of the heterochromatin. The higher levels of H3K9me<sub>3</sub> in mH2A1-OE were confirmed by western blot analysis. Overexpression of mH2A1 in stromal cells also induced metabolic reprogramming with the acquisition of a more glycolytic metabolism characterized by decreased levels of NAD<sup>+</sup>/NADH, upregulation of LDHA and MCT4. As LDHA could translocate into the nucleus, we evaluated if it used a noncanonical enzymatic activity in mH2A1-OE. Data showed increased nuclear localization of LDHA producing histone H3K79 hypermethylation. Finally, we treated ex-vivo HC- and MDS-MSCs with azacytidine founding a significant reduction both of mH2A1 and TLR4 associated to lower levels of nuclear NFκB after treatment.

**Conclusion:** Our data provide a key role of mH2A1 in driving the crosstalk between epigenetic signaling, inflammation and cell metabolism networks giving proof of concept for epigenetic therapy of MSCs in MDS.

## P14

## A MULTICENTRIC PROSPECTIVE PILOT STUDY ON FERROPTOSIS BIOMARKERS IN LOW-RISK MYELODYSPLASTIC SYNDROME

C. D'avino<sup>1</sup>, A. Pantaleo<sup>1</sup>, I. Tsamesidis<sup>1,2</sup>, F. Pilo<sup>3</sup>, K. Reybier<sup>4</sup>, A. Manca<sup>1</sup>, M. Greco<sup>3</sup>, C. Fozza<sup>5</sup>

<sup>1</sup>Department of Biomedical Science, University of Sassari, Italy; <sup>2</sup>Aristotle University of Thessaloniki, Greece; <sup>3</sup>Hematology Unit and Transplant Center. "A. Businco" Hospital, Cagliari, Italy; <sup>4</sup>PharmaDev, Université de Toulouse, France; <sup>5</sup>Department of Medical, Surgical and Experimental Sciences, University of Sassari, Italy

**Introduction:** Iron is an essential metal in cell life, but when in excess favors the production of reactive oxygen species (ROS) that are cytotoxic and lead to ferroptosis. Ferroptosis is recently described as a process of programmed cell death mediated by iron-dependent lipid peroxidation of cell membranes. The systemic control of iron is profoundly changed in anemias with acquired ineffective erythropoiesis like myelodysplastic syndrome (MDS) where iron is over mobilized by dyserythropoiesis per se and transfusion dependency. The only cellular system known to counter the increase in ROS is the antioxidant system, which is less efficient in MDS than in healthy controls. The main hypothesis is that cytotoxicity is not merely and directly caused by stored iron, but by an abnormality in the balance at cellular level between ROS level and antioxidant system that triggers the induction of oxidative stress, which leads to cellular ferroptosis. Furthermore, the classic biochemical and diagnostic markers of iron overload do not detect ferroptosis activity in MDS.

**Patients, Material and Methods:** This is a pilot prospective multicenter study enrolling 29 low-risk IPSS MDS (LR-MDS) from Cagliari and Sassari Hematology Unit. All patients collected sample at baseline and after 12 months, 10 health samples have been used as control. Patients are divided in 3 groups: 3 patients defined as LR-MDS without transfusion-dependency (LR-MDS not TD), 8 patients as LR-MDS with transfusion dependency but not under iron-chelation therapy (TD-MDS not ICT) and finally 12 patients as LR-MDS with transfusion dependency under iron-chelation therapy (TD-MDS on ICT). Median age was 69 years (range 45-87). They are testing for total antioxidant capacity (TAC), Glutathione (GSH), plasmatic ROS and the product of ferroptosis malondialdehyde (MDA). TAC is testing by colorimetric reaction, as well as GSH. ROS by fluorescent probe, MDA by indirect reactions and colorimetric detection. Coumarin Boronic Acid Coumarin (CBA) and Dihydroethidium (DHE) by liquid chromatography/mass spectrometry. Statistical analysis of the variance of the parameters was performed with software R.



Figure 1.

**Results:** Twenty-nine LR-MDS patients have been tested in our institutions. Antioxidant systems (TAC and GSH) are increased at baseline and after 12 months in all 3 groups compared to control, also in the first group (LR-MDS not TD). Moreover, ROS and MDA are increased at baseline and after 12 months in all 3 groups compared to control and increase after one year in all groups. The hydrogen peroxide is not significantly higher than the value obtained in the control group, instead the superoxide anion is greater in all 3 groups compared with the healthy control and reaches the highest values in the second group (TD-MDS not ICT)

**Conclusion:** Our pilot study confirms the abnormality in the balance at cellular level between ROS levels and antioxidant systems. Antioxi-

dant systems are increased also in the first group (LR-MDS not TD) suggesting that dyserythropoiesis alone would trigger a protective mechanism against oxidative stress by increasing the production of antioxidant molecules. The increased MDA value confirm that ferroptosis is present in this population compared to healthy population. Furthermore, superoxide anion seems to be the main imputes for cellular damage and the fact that is less present in LR-MDS patients under iron-chelation therapy, confirm the protective role of iron chelation. The next step to better understand the role of this bio-markers should be enlarge the study population and calculate multivariate statistical analysis respect to LR-MDS subtype, ferritin, transferrin saturation and type and dosages of iron-chelators.

## P15

### INFLAMMAGING VERSUS INFLAMMATION OF MDS: IS AGING A PRE-MDS STATE?

E. Tofacchi<sup>1,2</sup>, M. Cassari<sup>1</sup>, S. De Pourcq<sup>1,2</sup>, M.G. Raddi<sup>1</sup>, A. Consagra<sup>1</sup>, A. Sanna<sup>1</sup>, V. Santini<sup>1</sup>

<sup>1</sup>Myelodysplastic syndrome laboratory, Department of Experimental and Clinical Medicine, Florence University; <sup>2</sup>Department of Medical Biotechnologies, Università degli Studi di Siena, Italy

Aberrant innate immune activation and pro-inflammatory signaling within the malignant clone and the bone marrow (BM) microenvironment have been identified as possible key pathogenic drivers of myelodysplastic syndromes (MDS). In particular, S100A9 mediated NLRP3 inflammasome activation induces pyroptosis, that determines many of the hallmark features of the disease. Pro-inflammatory cytokines have long been suggested to play an important role in ineffective hematopoiesis typical of myelodysplastic syndromes. Specifically, early insights into aging processes and in parallel into the pathogenesis of MDS highlighted elevations of inflammatory cytokines including tumor necrosis factor-alpha (TNF-alfa) and IL-1 in MDS, which appeared to contribute to bone marrow progenitor intra-marrow apoptosis. In this scenario, we aimed to evaluate the inflammatory pattern at diagnosis and its possible modulation during treatment, analyzing bone marrow aspirates and sera obtained from two specific WHO subtypes of MDS: ring sideroblast MDS (MDS-RS) and MDS with chromosome 5 deletion (del5q) patients. We evaluated TGF-beta, TNF-alfa; TRAIL, IL-1beta; IL-1alfa; IL-10; IL-6; IL-18; INF-gamma and S100A8/A9 serum levels in 23 cases of MDS-RS, IPSS-R lower risk (2 very low, 19 low, 2 intermediate cases) and 10 cases of Del5q- LR-MDS (1 very low, 6 low, 3 intermediate cases) by ELISA methods, with follow up at different time points during therapy with erythropoietin, luspatercept and lenalidomide. Among these, 5/33 cases progressed to higher risk MDS and cytokine levels were measured also at progression. Pro inflammatory cytokines signature evaluation will be completed with the same methods in serum samples obtained from at least 10 age and sex matched healthy subjects. The results obtained from the comparison of the two groups will possibly identify as biomarker a specific cytokine signature typical of MDS, differing from the "physiological" inflammaging.

## P16

### LOW DOSE VENETOCLAX/CYTARABINE THERAPY IS EFFECTIVE AND SAFE IN RELAPSED/REFRACTORY HIGH-RISK MYELODYSPLASTIC SYNDROME PATIENTS FAILED PREVIOUS HYPOMETHYLATING AGENT'S TREATMENT

M.F. Ruda<sup>1,2</sup>, F. Pilo<sup>1</sup>, G. Caocci<sup>1,2</sup>, M. Pettinau<sup>1</sup>, C. Romani<sup>1</sup>, P. Garau<sup>1</sup>, G. La Nasa<sup>1,2</sup>

<sup>1</sup>Hematology Unit and Transplant Center. "A. Businco" Hospital, Cagliari; <sup>2</sup>Department of Medical Science and Public Health, Cagliari University, Italy

**Introduction:** Hypomethylating agents (HMAs) have been considered standard of care for high risk myelodysplastic syndrome (MDS). Despite their low toxicity and ability to induce prolongation of survival, even in elderly patients, HMAs do not eradicate neoplastic clones so that the effect is transient, with responses maintained for 6 to 24 months.

Survival of those patients with relapsed/refractory (R/R) disease is extremely short and prognosis is exceptionally poor, with a median overall survival of 4–6 months. Options therapy after HMA failure are scarce and supportive care or low-dose chemotherapy are the most common. Venetoclax (an oral BCL2 inhibitor) has been employed with success in combination with low-dose cytarabine or HMAs for patients with R/R AML and for a small number of MDS. However, R/R MDS patients are defined by usually profound and lasting cytopenia and more vulnerable to drug toxicities. Furthermore, dose delays and reductions observed in the phase I-II trials as well as the high rate of clinically relevant and prolonged neutropenia, it will be crucial to determine the optimal dosing schedule of this combination allowing for maximum benefit without undue toxicity in this vulnerable patient population.

**Material and Methods:** This is a single center retrospective study involving 14 R/R HR-MDS patients failed HMA. All patients received Venetoclax 50 mg/die for 28 day plus Citarabine 20 mg/m<sup>2</sup> for 10 days every month as "OFF LABEL" treatment, approved and refund by AIFA 5% process. Patients' characteristics are described in table 1. Median age was 73 years, 12/14 were male, cytogenetic risk were: low 5/14, Intermediate 4/14, high 3/14 and 2 patients were not detected. All patients received a previous therapy with Azacitidine. All patients have an outpatient management during therapy. All patients received antifungal prophylaxis with posaconazole or fluconazole. Adverse events were graded according to CTCAE v 4.03. Survival is estimated with Kaplan-Meier method.

**Results:** Fourteen R/R HR-MDS patients have been treated in our institution in the last 2 years (from 2020 to 2021). The early 30-days and 60-days mortalities were 7% and 28% respectively. Overall with a median follow-up 24 months we reported 12/14 adverse events (AEs) (almost all grade III-IV) but only 2/14 patients required hospitalization, whereas 10/14 were solved after temporary Venetoclax discontinuation; the most common AE were hematological (12/14) or infective (5/12). No case of tumor lysis syndrome were detected. Delayed cycle has been described in 50% of patients (median days delay: 38,5); CR rate was observed in 14%, ORR (CR+Cri+HI) 71% patients. Median follow up was 24 months and median OS was 8 months (95% C.I.= 3.1-12.7) (Figure 1).

**Conclusion:** R/R MDS patients have an extremely poor outcome with limited therapeutic opportunities and they should always be considered for clinical experimental trials but often inaccessible in every institution. With the limitation of a single center experience and restricted population, our study shows that low dose Venetoclax/cytarabine is effective and safe in an outpatient management and show a prolonged survival. Expanding of study population is needed to confirm this data.

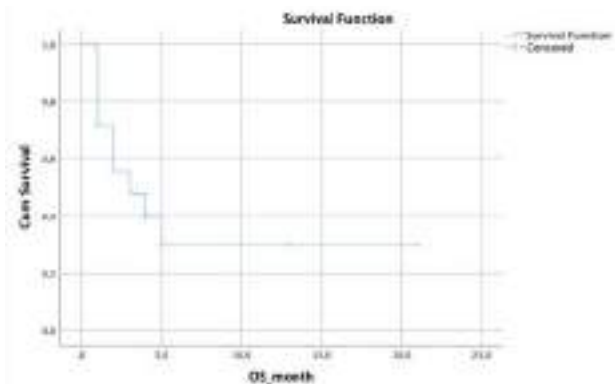

Figure 1. Overall Survival at 24 months.

**P17****PRELIMINARY PROSPECTIVE MOLECULAR ANALYSIS OF PLCBETA1 AND PLCGAMMA2 IN MDS PATIENTS TREATED WITH AZACITIDINE AND VENETOCLAX**

A. De Stefano<sup>1</sup>, S. Mongiorgi<sup>1</sup>, S. Ratti<sup>1</sup>, M. Fogli<sup>2</sup>, V. Salvestrini<sup>2</sup>,  
A. Curti<sup>2</sup>, M. Cavo<sup>2</sup>, A. Pellagatti<sup>3</sup>, J. Boulwood<sup>3</sup>, L. Manzoli<sup>1</sup>,  
L. Cocco<sup>1</sup>, S. Parisi<sup>2</sup>, S. Paolini<sup>2</sup>, C. Finelli<sup>2\*</sup>, M.Y. Follo<sup>1\*</sup>

<sup>1</sup>Biomedical and Neuromotor Sciences, University of Bologna, Italy;  
<sup>2</sup>IRCCS Azienda Ospedaliero-Universitaria di Bologna - Istituto di Ematologia "Seràgnoli", Italy; <sup>3</sup>Blood Cancer UK, University of Oxford, UK

**Introduction:** Azacitidine (AZA) is a standard treatment for MDS patients. The addition of Venetoclax (VEN) to AZA is effective in MDS and AML. Indeed, AZA+VEN is now used in de novo AML patients, but it shows a favourable clinical effect also in higher-risk MDS patients. At a molecular level, a favourable response to AZA is linked to an increased expression of PLCbeta1 and PLCgamma2, two phospholipases (PLCs) implicated in the regulation of cell proliferation and differentiation. AZA positive effect also results in increased expression of myeloid differentiation markers (CD33, CD11b and CD14). Here, we prospectively analyzed the effect of AZA, alone or in combination with VEN, in higher-risk MDS patients on the basis of the expression of PLCs and myeloid differentiation markers.

**Methods:** The study included 9 higher-risk MDS. Six of them were treated with AZA (75 mg/m<sup>2</sup>/day for 5 days) and in 3 of them VEN (400 mg oral tablet once daily on days 1-14) was added to AZA. All samples came from the Institute of Hematology "Le A Seràgnoli", Bologna, Italy, where also all clinical evaluations are made. As it is a preliminary prospective analysis, clinical data are currently being collected and molecular experiments were performed only in the first three cycles of therapy, when patients were not yet clinically evaluable for response. Mononuclear cells were collected at baseline and during the first three cycles of AZA/AZA+VEN, and Real-time PCR analyzed the expression of PLCbeta1, PLCgamma2, CD33, CD11b and CD14, using GAPDH as endogenous control. Baseline levels within the same patient were used as the internal reference.

**Results:** 3/6 patients treated with AZA alone showed a higher PLCbeta1 and PLCgamma2 expression during treatment. They also showed an increased expression of the myeloid differentiation markers (CD33, CD11b and CD14). In contrast, the remaining 3 patients treated with AZA alone exhibited a significant reduction of PLCbeta1, PLCgamma2, CD33, CD11b and CD14. All 3 patients treated with AZA+VEN displayed a higher amount of both PLCs and the myeloid differentiation markers. Interestingly, the increase detected during the combination therapy seems to be greater, as compared with AZA alone, thus it could be possible to hypothesize that the addition of VEN could enhance the effect of AZA in these patients.

**Conclusions:** Based on our molecular data, the 9 patients analyzed may be divided into 3 groups: 3 patients seem to be responders and 3 patients seem to be non-responders to AZA alone, while all 3 patients treated with AZA+VEN seem to be responders. Clinical data for patients reaching the 6th cycle, or showing a favourable response even before the 6th cycle, may support this molecular-based hypothesis, that has to be reinforced by analyzing a larger number of patients. Furthermore, given the Bcl-2 inhibitory effect of VEN, *in vitro* leukemic analyses could disclose the role of the combined therapy on PLC signaling and myeloid differentiation.

**P18****DECREASED LOW-DENSITY GRANULOCYTES AS POSSIBLE DIAGNOSTIC MARKERS OF MYELODYSPLASTIC SYNDROMES WITH EXCESS OF BLASTS**

V. Giudice<sup>1,2</sup>, I. Ferrara<sup>1</sup>, M. Gorrese<sup>1</sup>, A. Bertolini<sup>1</sup>, R. Pepe<sup>1</sup>, F. D'Alto<sup>1</sup>,  
P. Manzo<sup>1</sup>, M. D'Addona<sup>1</sup>, M.C. Martorelli<sup>1</sup>, M. Langella<sup>1</sup>, B. Cuffa<sup>1</sup>,  
B. Serio<sup>1</sup>, C. Selleri<sup>1,2</sup>

<sup>1</sup>Ematologia e Centro Trapianti di Midollo, Azienda Ospedaliera Universitaria "San Giovanni di Dio e Ruggi d'Aragona"; <sup>2</sup>Dipartimento di Medicina, Chirurgia ed Odontoiatria "Scuola Medica Salernitana",

Università degli Studi di Salerno, Italy

**Introduction:** Myelodysplastic syndromes (MDS) are a heterogeneous group of clonal hematological diseases characterized by ineffective hematopoiesis, progressive peripheral blood (PB) cytopenia(s), and increased risk of acute myeloid leukemia (AML). Risk stratification and prognostic definition are essential for a better clinical management of these patients. Here, we investigated variations in frequency of low-density granulocytes (LDGs), a neutrophil subset with immune regulatory functions, in MDS as candidate biomarkers of AML progression.

**Methods:** A screening cohort of 25 patients were enrolled at the Hematology and Transplant Center, University Hospital "San Giovanni di Dio e Ruggi d'Aragona", Salerno, Italy, between October 2020 and July 2021. Seven patients were diagnosed with AML (N=3 newly-diagnosed; N=4 AML in complete remission, CR), MDS with multilineage dysplasia (MDS-MD, N=8) or with excess of blasts (EB, N=3), or with other hematological conditions (N=7). Fresh whole PB was stained for immunophenotyping, and samples acquired on a Navios EX flow cytometer (Beckman Coulter). Post-acquisition analysis was performed using Kaluza software (Beckman Coulter). LDGs were identified as CD3-CD56-CD19-CD11b+CD33+CD14-CD15+ cells, as previously described (Rahman S, et al. Ann Rheum Dis. 2019). Statistical analysis was carried out using Prism (GraphPad, La Jolla, CA). A P < 0.05 was considered statistically significant.

**Results:** LDGs were significantly reduced in MDS-EB compared to lower-risk dysplasia (P = 0.0098), other benign hematological conditions (P = 0.0025), and AML patients in CR (P = 0.0351), while no differences were described between MDS-EB and newly-diagnosed AML (P = 0.7396), proposing circulating LGD frequency as diagnostic and prognostic marker. Similarly, normal-density granulocytes (NDGs) tended to be decreased in MDS-EB compared to other groups (P = 0.2846; one-way ANOVA performed). No significant variations in LDG maturation curve were described, even though MDS-EB and newly-diagnosed AML tended to have lower frequency of mature LDGs compared to lower-risk MDS, AML in CR, and other benign hematological conditions (P = 0.4325). Similarly, no significant variations in NDG maturation curve were observed, even though MDS-EB tended to have lower frequency of immature and mature NDGs compared to lower-risk MDS, AML at baseline and in CR, and other benign hematological conditions. Percentage of LDGs was inversely related to percent of lymphocytes (r = -0.5775; P = 0.0031) and blasts (r = -0.9476; P < 0.0001), while positively correlated with NDG frequency (r = 0.6636; P = 0.0002).

**Conclusions:** Our preliminary results suggested a possible role of LDGs in diagnostic definition of higher-risk MDS patients for differential diagnosis of myelodysplasia and AML. However, our findings need further validation in larger cohorts.

**Funding:** This research was supported by the Aplastic Anemia & MDS International Foundation.

**P19****SUPPORTIVE CARE IN LOW-RISK MYELODYSPLASTIC SYNDROMES: ROLE OF ERYTHROPOIESIS STIMULATING AGENTS (ESAs)**

C. Cerchione<sup>1</sup>, F. Alfinito<sup>2</sup>, I. Soriente<sup>3</sup>, A.M. D'Arco<sup>3</sup>, P. Danise<sup>3</sup>,  
G. Cerciello<sup>3</sup>, G. Musuraca<sup>1</sup>, A. Lucchesi<sup>1</sup>, V. Di Battista<sup>1</sup>,  
D. Cangini<sup>1</sup>, M.B. Giannini<sup>1</sup>, S. Ronconi<sup>1</sup>, M. Ceccolini<sup>1</sup>, F. Pane<sup>2</sup>,  
G. Martinelli<sup>1</sup>

<sup>1</sup>Hematology Unit, Istituto Scientifico Romagnolo per lo Studio e la Cura dei Tumori (IRST) IRCCS; <sup>2</sup>Hematology, AOU Federico II; <sup>3</sup>Hematology, Ospedale di Pagani, Italy

Erythropoiesis stimulating agents (ESAs) are the frontline treatment in low-risk anemic MDS patients and an employment of this therapy in the earlier stage of the disease can delay the need for RBC transfusion, hypothetically by slowing the disease course. It's matter of debate whether the clinical response is a result of proliferation and maturation of the dysplastic clone or stimulation of residual normal erythropoiesis by ESAs. Macrocytosis is one of the cytological hallmarks of dyserythropoiesis in MDS: an analysis of the erythropoietic response to ESAs therapy in a cohort of anemic non transfusion-dependent MDS patients,

enrolled in a retrospective register, RECAMDS, subgroup of Italian register, was performed. 183 patients, treated with standard-dose ESAs, have been retrospectively analyzed. Data analysis was performed, according to IWG 2006 criteria, at the baseline, after 3 and 6 months of continuous treatment, with a subanalysis of the patients according to WHO and R-IPSS risk stratification. ESAs were started at mean Hb concentration of 9.31 g/dl, mean serum EPO concentration: 51 mU/L, after a mean time from diagnosis of 6 months (r.1-118). ORR was 83.6% (153/183), no difference among WHO and IPSS subgroups was found: 132/183 (72.1%) achieved response after 3 months of treatment, while other 21/183 (11.2%) after 6 months. 19 patients with stable disease (non-responders, according to IWG criteria), in which treatment was continued, achieved response after 9 months. In the macrocytic-responders group 83.2% exhibits again macrocytosis after 3 months, while 16.8% become normocytic. In the normocytic-responders group 89.8% exhibits again normocytosis, while 10.2% become macrocytic: in these patients, after 3 months, there was a contemporary worsening in neutropenia and thrombocytopenia, with transfusion-dependence, regarded as first signs of progression of disease. Non-responders were 30/183 (16.3%): in the macrocytic non-responders group 89% exhibit again macrocytosis after 3 months, while 11% become normocytic; in the normocytic group 76% exhibits again macrocytosis, while 24% become normocytic. These preliminary data can suggest that, in the majority of MDS patients responsive to ESAs, the increase of Hb concentration occurs mainly stimulating erythroid production in MDS clones; in the minority of patients probably it happens recruiting residual polyclonal erythropoiesis. It is interesting to note that stimulating effects of ESAs last even when the expression of dysplasia progresses.

Table 1.

MDS PATIENTS		183
M		89 (49%)
F		94 (51%)
<b>ERYTHROPOIESIS</b>		
BASELINE HB (mean, g/dl)	9.31 g/dl (r. 7.1-11.3)	
BASELINE SERUM EPO (mean, mU/mL)	51 mU/mL (r.3-84)	
<b>OVERALL RESPONSE RATIO</b>		
RESPONDERS	153/183 (83.6%)	
RESPONDERS AT 3 MONTHS	132/183 (72.1%)	
RESPONDERS AT 6 MONTHS	21/183 (11.4%)	
RESPONDERS AT 9 MONTHS (NON RESPONDERS IN IWG 2006)	19/183 (10.3%)	
NON RESPONDERS	30/183 (16.3%)	

## Acute Leukemias

### P20

#### FUSION CIRCNRNAS FROM THE *KMT2A:AFF1* CHIMERIC GENE IN PEDIATRIC B-ALL PATIENTS AND CELL LINES HARBORING THE T(4;11)(Q21.3-Q22.1;Q23.3) TRANSLOCATION

D. Tolomeo<sup>1</sup>, G. Fazio<sup>2</sup>, G. Visci<sup>1</sup>, G. Cazzaniga<sup>2,3</sup>, C.T. Storlazzi<sup>1</sup>

<sup>1</sup>Dipartimento di Biologia, Università degli Studi di Bari Aldo Moro; <sup>2</sup>Centro di Ricerca Tettamanti, Università di Milano-Bicocca/Fondazione MBBM; <sup>3</sup>Genetica Medica, Dip. Medicina e Chirurgia, Università di Milano-Bicocca, Italy

**Introduction:** Circular RNAs (circRNAs) are endogenous transcripts originated as back-splicing products. Their circular structure confers higher stability than linear transcripts, resulting in their involvement, when deregulated, in several human diseases, including cancer. Increasing literature documents a predominant non-coding role as micro RNA sponges or transcriptional regulators, affecting the expression of genes involved in cell proliferation, invasion, apoptosis, and angiogenesis. circRNAs are also generated by the back-splicing of linear fusion transcripts derived from genomic rearrangements, giving rise to fusion circRNAs (f-circRNAs), as demonstrated in hematological and solid tumors harboring recurrent chromosomal rearrangements.

**Methods:** By analyzing six bone marrow (BM) samples from pediatric patients at diagnosis of B-cell Acute Lymphoblastic Leukemia (B-ALL) and two cell lines (SEM and MV4-11), we investigated if the linear *KMT2A:AFF1* fusion transcript, originated by the recurrent balanced t(4;11)(q21.3-q22.1;q23.3) translocation, might generate f-circRNAs. We performed RT-PCR and Sanger sequencing experiments with divergent primers, designed on each linear fusion transcript sequence, on RNase R-digested RNA samples, using a pool of normal BM samples and the pre-B cell line NALM-6 as negative controls. RT-qPCR also evaluated the *KMT2A:AFF1* f-circRNA expression in positive and negative samples, including B-ALL patients with the t(12;21) translocation or a normal karyotype.

**Results:** The RT-PCR and Sanger sequencing results in SEM and MV4-11 cell lines indicated the generation of three f-circRNAs showing the back-splicing of *AFF1* exon 8 with either *KMT2A* exon 2 or exon 1 and *AFF1* exon 11 with *KMT2A* exon 2. The obtained products were not digested by RNase R treatment, confirming their circular structure. Notably, the first and the third isoforms were also observed in pediatric B-ALL patients with the t(4;11) translocation, but not in patients without this rearrangement, indicating specificity for t(4;11) positive patients. Furthermore, one patient, tested in samples at onset and relapse, displayed the persistence of both f-circRNAs isoforms.

**Conclusions:** Identifying specific f-circRNAs from the *KMT2A:AFF1* fusion transcript is of relevance, as this evidence could help better understand the role of the t(4;11) rearrangement in the biology of pediatric B-ALL. The oncogenic role of such transcripts is under evaluation by *in vitro* studies. Furthermore, circRNAs and f-circRNAs are considered novel "liquid biopsy" biomarkers for early and non-invasive diagnosis of tumors, as well as therapeutic targets in human cancer. Therefore, such molecules may be crucial for future diagnostic/follow-up approaches and personalized therapies to improve treatment efficacy in t(4;11) positive pediatric B-ALL.

### P21

#### ABERRANT CIRCNRNAS AS NEW PLAYERS IN MLL-AF4 ACUTE LEUKEMIA

A. Dal Molin<sup>1\*</sup>, C. Tretti Parenzan<sup>2\*</sup>, E. Gaffo<sup>1</sup>, E. Boldrin<sup>3</sup>, P. Guglielmelli<sup>4</sup>, A.M. Vannucchi<sup>4</sup>, L.H. Meyer<sup>3</sup>, A. Biffi<sup>2</sup>, B. Buldini<sup>2</sup>, G. te Kronnie<sup>1</sup>, S. Bresolin<sup>2,5</sup>, S. Bortoluzzi<sup>1,5</sup>

<sup>1</sup>Department of Molecular Medicine, University of Padova, Padova, Italy; <sup>2</sup>Department of Women's and Children's Health, University of Padova, Padova, Italy; <sup>3</sup>Department of Pediatrics and Adolescent Medicine, Ulm University Medical Center, Ulm, Germany; <sup>4</sup>CRIMM, Center for Research and Innovation of Myeloproliferative Neoplasms,

AOU Careggi, Department of Experimental and Clinical Medicine, University of Florence, Florence, Italy. \*Equally contributing first authors. <sup>5</sup>Equally contributing last authors

In *MLL* rearranged acute lymphoblastic leukemia (ALL), fusions of *MLL* with over 90 partner genes generate leukemogenic fusion proteins whose activity determines deep transcriptome and proteome alterations. In *MLL* rearranged ALL we previously observed the dysregulation of circRNA from genes of the *MLL* recombinome (Dal Molin et al. *Front. Oncol.* 2019). Next, we obtained a genome-wide picture of circRNA expression specificities of the most frequent *MLL* rearranged ALL in infants, *MLL-AF4* leukemia, as a starting point to discover new molecular mechanisms of malignant transformation. CirComPara (Gaffo et al. *Briefings in Bioinformatics* 2021) software was used to quantify circRNAs from public and proprietary RNA-seq datasets (ribo-depleted RNA; Illumina® HiSeq2000, PE 100 nt reads) of blast cells of 6 *MLL-AF4* B-ALL patients and patient-derived samples, the RS4;11 model and human hematopoietic cells (CD34+, mature B-, T-cells and monocytes). Differential expression analysis was performed through DESeq2 (p.adj<0.05). Sanger sequencing and targeted quantification by qRT-PCR were used for circRNA validation and screening. A custom siRNA assay has been designed to silence a panel of circRNAs in the RS4;11 and SEM cell lines. Apoptosis and cell proliferation were measured using Annexin/PI and Edu assays, respectively. A software tool newly developed by our group, CRAFT (Dal Molin et al. *under evaluation*), was used to predict miRNA and RNA binding protein binding sites of circRNAs and their coding potential. Linear and circular fusion transcripts (f-circRNA) were detected using a custom-developed software for analysis of RNA-seq data and with a massive screening by RT-PCR. Among over 74,000 circRNAs expressed in normal and malignant blood cells, we identified 1,236 circRNAs differentially expressed in *MLL-AF4* ALL compared with CD34+ and B-cells. Moreover, one *MLL-AF4* f-circRNA was consistently detected by both the bioinformatic and the experimental screening. We next focused on 64 circRNAs upregulated consistently in *MLL-AF4* patient and patient-derived samples compared with both normal populations. Twenty-six circRNAs ectopically expressed in *MLL-AF4* samples and robustly expressed in the RS4;11 cell line were prioritized for functional screening *in vitro*. Fourteen circRNAs were silenced with an efficiency greater than 75% in two cell lines. Functional experiments provided robust data about a measurable effect of the silencing on cell proliferation and/or apoptosis for several circRNAs with oncogenic properties. Leveraging functional predictions and gene expression data analysis we are investigating the possible cooperation of multiple oncogenic circRNAs with correlated expression in *MLL-AF4* patients (Tretti, Dal Molin et al. *in preparation*). In conclusion, we provided the first comprehensive data of the dysregulated circRNAome in *MLL-AF4* leukemia, detected *MLL-AF4* fusion circRNAs and, notably, unveiled the functional impact of several circRNAs in this leukemia.

## P22

### ALTERATION OF OSTEOGENIC DIFFERENTIATION INDUCED BY ACUTE MYELOID LEUKEMIA IN THE HEMATOPOIETIC NICHE: A POSSIBLE ROLE OF NOTCH SIGNALING

C. Tomasoni, C. Arsuffi, A. Biondi, A. Pievani, M. Serafini

Tettamanti Research Center, Department of Pediatrics, University of Milano-Bicocca/Fondazione MBBM, Italy

**Introduction:** Acute myeloid leukemia (AML) is a malignant disease characterized by the abnormal clonal proliferation of undifferentiated blasts and by a high relapse rate, associated with chemoresistance and bone marrow (BM) failure. These processes are supported by the alterations in the stromal component of the hematopoietic niche due to the interactions with leukemic cells. We have previously demonstrated that mesenchymal stromal cells (MSC) obtained from patients' BM presented intrinsic alterations in osteogenesis. We wondered if Notch signaling can be involved in these alterations.

**Methods:** We established an *in vitro* co-culture system in which osteogenesis is induced in normal MSC in the presence of different AML cell lines, primary AML cells, or healthy CD34+ cells. We then evaluated the expression of Tissue Non-specific Alkaline Phosphatase (TNAP), a

marker of early osteogenesis, on the MSC surface. Moreover, we evaluated the expression of genes involved in Notch signaling and in osteogenesis, in supporting normal hematopoiesis and in sustaining leukemia survival and progression.

**Results:** MSC cocultured for 3 days in direct contact with AML cell lines showed increased expression of TNAP and reduction of osteopontin and osteocalcin, markers of late osteogenesis. Furthermore, coculture of primary AML cells with normal MSC showed significant upregulation of TNAP expression, while coculture with normal CD34+ cells did not affect TNAP levels. Then we found that Notch1-2-3, Hes1 and Hey1 levels were markedly increased in MSC cocultured with AML cell lines. To prove the association between increased Notch signaling and altered early-stage osteogenesis, we added DAPT, a  $\gamma$ -secretase inhibitor, which successfully abrogated TNAP upregulation in MSC cocultured with AML cell lines and primary blasts. Furthermore, stimulation with recombinant Jagged1 induced a strong upregulation of TNAP on MSC. Moreover, the presence of AML cells induced in MSC an upregulation of genes involved in the leukemogenesis and a decrease of HSC-supporting factors. Lastly, we are evaluating if the activation of Notch signaling by AML cells can affect the normal glucose metabolism in MSC.

**Conclusions:** Our data indicate that AML cells induce in MSC an alteration in early-stage osteogenesis that is at least partially mediated through activation of Notch signaling. MSC skewed toward osteoprogenitors show significant downregulation of HSC-supporting factors and upregulation of genes sustaining AML growth, suggesting that they can contribute to the formation of a «leukemic niche» that become permissive on leukemia growth and disrupts normal hematopoiesis. These novel insights into the human AML BM microenvironment may help identify new targets which might pave the way for niche-targeted therapies in AML patients.

## P23

### NOVEL COMPOUNDS SYNERGIZE WITH VENETOCLAX TO TARGET KMT2A-REARRANGED ACUTE MYELOID LEUKEMIA

C. Tregnago, M. Benetton, A. Da Ros, G. Borella, G. Longo, K. Polato, S. Francescato, A. Biffi, M. Pigazzi

Divisione di Emato-Oncologia Pediatrica e Terapia Cellulare e Genica, Dipartimento di Salute della Donna e del Bambino, Università degli Studi di Padova, Italy

**Introduction:** In pediatric acute myeloid leukemia (AML), fusions involving lysine methyltransferase 2A (KMT2A) are considered hallmarks of aggressive AML, for whom the development of targeted specific therapeutic agents to ameliorate classic chemotherapy and obtain a complete eradication of disease is urgent.

**Methods:** In this study we investigated the levels of antiapoptotic proteins BCL-2, phospho-BCL-2 S70 and MCL-1 in a cohort of 66 pediatric AML patients previously analyzed by Reverse Phase Protein Array (RPPA). To increase apoptosis in KMT2A-r subgroup, we selected novel drug combinations to be tested in KMT2A-MLLT3, for being the most recurrent, and KMT2A-AFDN, for mediating the worst prognosis, rearranged AML, using both AML cell lines and ex vivo primary cells. We validated the best drug combinations in a three-dimensional (3D) scaffold mimicking the bone marrow niche.

**Results:** We found that 75% of the KMT2A-r are distributed in Q3+Q4 quartiles of BCL-2 expression, with high levels of phospho-BCL-2 S70 and MCL-1 as well, indicating a high anti-apoptotic pathway activation. In attempt to target it, we tested novel drug combinations of venetoclax, a B-cell lymphoma-2 (BCL-2) inhibitor, in KMT2A-MLLT3 and KMT2A-AFDN rearranged AML. Our screening revealed that both Bromodomain and Extra-Terminal Domain (BET) inhibitor, I-BET151, and kinase inhibitor, sunitinib, decreased BCL-2 family protein expression and synergized with venetoclax enhancing KMT2A-r AML cell death. The t(6;11) KMT2A-AFDN subgroup was shown also to be highly responsive to the combination of venetoclax and thioridazine, with synergy being induced by a dramatic increase of mitochondrial depolarization that triggered blasts apoptosis. Finally, efficacy of novel combined drug treatments was confirmed in a three-dimensional system, which

mimics the bone marrow niche seeded with mesenchymal stromal cells and ex vivo primary KMT2A-r AML samples.

**Conclusions:** Overall, this study identified that by an high throughput screening the most KMT2A selective drugs converged in different but all mitochondrial apoptotic networks activation, supporting the use of venetoclax in this AML setting. Novel drugs combinations here unveiled provide a rationale for evaluating these combinations in preclinical studies to accelerate the introduction of targeted therapies for the life-threatening KMT2A-AML subgroup of pediatric AML.

## P24

### EXPLORING THE ROLE OF PVT1 ISOFORMS AND CIRC-PVT1 IN PROMOTING AN AGGRESSIVE PHENOTYPE IN AML CELL LINES

M. Ghetti<sup>1</sup>, A. Padella<sup>1</sup>, E. Fonzi<sup>1</sup>, L. Ledda<sup>1</sup>, A. Ghelli Luserna di Rorà<sup>1</sup>, M. Paganelli<sup>1</sup>, D. Tolomeo<sup>2</sup>, C.T. Storlazzi<sup>2</sup>, G. Martinelli<sup>1</sup>, G. Simonetti<sup>1</sup>

<sup>1</sup>Istituto Scientifico Romagnolo per lo Studio e la Cura dei Tumori "Dino Amadori"; <sup>2</sup>University of Bari, Italy

Non-coding (nc)RNAs, including circular (circ)RNAs, contribute to tumor development and progression. Several ncRNAs were shown to affect the onset, prognosis, and treatment of acute myeloid leukemia (AML) in the past years. The human Plasmacytoma Variant Translocation 1 (PVT1) gene maps on the long arm of chromosome 8 (8q24), in the same genomic region hosting MYC and encoding for 83 linear (PVT1, Incipedia.org) and 26 high-confidence circular isoforms (circ-PVT1, www.circbase.org). The most common isoform of circPVT1 is a product of back-splicing of 410 nt and contains the whole exon 2 of PVT1 in a closed loop-like structure (hsa\_circ\_0001821). The study aims to investigate the role of PVT1 isoforms and circPVT1 in AML. Firstly, we focused on the various PVT1 isoforms and their differential expression in leukemia. Fourteen out of the 83 linear isoforms are expressed in the hematopoietic tissues (lymph node and white blood cells, www.noncode.org), and 6 of them were detectable in AML cell lines, including the t(8;21) KASUMI-1 and the NPM1-mutated OCI-AML3 models, together with circPVT1. We designed two antisense-oligonucleotides (ASOs), mapping on common exonic region and targeting the linear isoforms expressed in OCI-AML3 and KASUMI-1 cells, and one ASO spanning the junction region of circPVT1. ASO-mediated knockdown (KD) showed a relevant decrease of PVT1 signals, especially by ASO combination, and circPVT1 level using the specific ASO in both cell lines, under normoxia and hypoxia (1% O<sub>2</sub>). The down-regulation led to a significant decrease in cell growth, but, interestingly, only circPVT1-KD induced apoptosis under both conditions in OCI-AML3. To further investigate the biological consequences of circPVT1-KD, we performed RNAseq assays. Data analysis was performed by pseudo alignment of paired-end reads to the human transcriptome, then counted with the Kallisto tool. Differential expression analysis of single isoforms was performed with the Sleuth tool on normalized transcript per million. We identified a core of 644 and 838 commonly regulated genes by circPVT1 in both cell lines under normoxia and hypoxia, respectively. Pathway analysis (performed by EnrichR) revealed that these genes are involved not only in the RNA regulatory pathways, as expected according to circRNA functions, but also in metabolic (e.g., KDM3A, GPI, NFKBA, RBM3, XBP1) and DNA damage response (e.g., PIDD1, MUC1, BCLAF1, BABAM2) pathways, opening a new scenario for synthetic lethality approaches. In conclusion, our findings show that silencing of circPVT1 or the predominantly expressed PVT1 isoforms dampens leukemia cell growth, indicating a role in AML pathogenesis, and suggest that targeting them may have therapeutic potentials in AML.

## P25

### THE ABSENT/LOW EXPRESSION OF CD34 IN NPM1-MUTATED AML IS NOT RELATED TO THE CYTOPLASMIC DISLOCATION OF NPM1 MUTANT

G. Pianigiani<sup>1</sup>, F. Rocchio<sup>1,2</sup>, S. Peruzzi<sup>1</sup>, V. Andresen<sup>3</sup>, M.P. Martelli<sup>1</sup>, L. Brunetti<sup>1,4</sup>, B. Falini<sup>1</sup>

<sup>1</sup>Dipartimento di Medicina e Chirurgia, Università degli Studi di Perugia; <sup>2</sup>Ricerca e Sviluppo, Dompé Farmaceutici S.p.A.; <sup>3</sup>Centre for Cancer Biomarkers (CCBIO), Department of Clinical Science, University of Bergen; <sup>4</sup>Dipartimento di Scienze Cliniche e Molecolari, Università Politecnica delle Marche

**Introduction:** The most distinguishing biological feature of NPM1-mutated AML that has also led to its discovery (Falini B. et al., *NEJM* 2005; 352(3):254-266) is the aberrant dislocation of NPM1 mutant (NPM1c) into the cytoplasm of leukemic cells (Falini B. et al., *Blood* 2020; 136(15):1707-1721). Another peculiarity of NPM1-mutated AML is the upregulation of HOX genes and the CD34 downregulation. We previously demonstrated that HOX genes upregulation is directly dependent on the cytoplasmic dislocation of NPM1 mutant (Brunetti L. et al., *Cancer Cell* 2018; 34(3):499-512.e9). In contrast, whether absent/low expression of CD34 is related to the stage of differentiation of the leukemic cells or to the cytoplasmic delocalization of the NPM1c remains unclear.

**Methods:** To investigate whether NPM1c nuclear relocalization could affect CD34 expression, OCI-AML3 cells (which carry NPM1 mutation A) were treated with the XPO1 inhibitor Selinexor (50nM) or DMSO (control). CD34 expression levels were assessed by flow cytometry (FC) at 12 and 24 hours. To obtain fast and targeted NPM1c degradation, CRISPR-engineered cell lines OCI-AML3 and IMS-M2 (also carrying NPM1 mutation A) with endogenous NPM1c fused to FKBP(F36V) degenon tag and GFP (NPM1c-FKBP(F36V)-GFP) were treated with dTAG-13 (500nM) or DMSO (control). NPM1c degradation was confirmed by FC analysis. CD34 expression was assessed at different time points (12, 24, 48 and 72 hours) by FC. To study the cell of origin of NPM1-mutated AML, NPM1c and CD34 co-expression was evaluated by immunohistochemistry in paraffin-embedded bone marrow (BM) biopsies from NPM1-mutated AML patients (n=10).

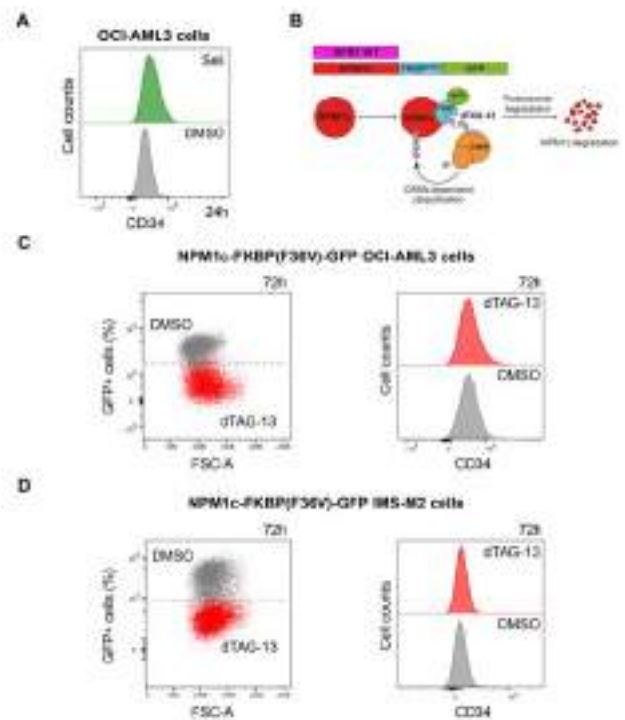

Figure 1.

**Results:** Treatment of NPM1-mutated OCI-AML3 cells with the



XPO1 inhibitor Selinexor caused NPM1c nuclear relocalization. Analysis of CD34 levels by FC, proved that CD34 expression levels remained unchanged, regardless of the NPM1c localization (A). These findings were also confirmed investigating CD34 expression at transcriptional level by qRT-PCR (not shown). Treatment of OCI-AML3 and IMS-M2 NPM1-mutated CRISPR-engineered cells (B) with dTAG-13 induced selective degradation of NPM1c, as confirmed by FC analysis of GFP expression (C-D, left panels). However, despite complete NPM1c degradation, CD34 levels were not changed among the different time points at FC (C-D, right panels) and qRT-PCR of CD34 expression level (not shown). Double immuno-enzymatic staining on *NPM1*-mutated AML patients' paraffin BM sections showed that the rare mononucleated cells expressing CD34 often co-expressed the NPM1c.

**Conclusions:** Low/absent CD34 expression in *NPM1*-mutated AML is not dependent on NPM1c cytoplasmic delocalization. Because the rare CD34<sup>+</sup> cells present in *NPM1*-mutated BM biopsies are NPMc<sup>+</sup> and *NPM1*-mutated leukemia initiating cells are CD34<sup>+</sup> (Martelli MP et al., *Blood* 2010; 116(19):3907-3922), the molecular mechanisms of CD34 downregulation in the bulky population of *NPM1*-mutated AML remains unclear.

## P26

### GUT MICROBIOME SIGNATURES ARE PREDICTIVE OF HEMATOLOGIC RECOVERY FOLLOWING INDUCTION THERAPY FOR ACUTE MYELOID LEUKEMIA

V. Salvestrini<sup>1</sup>, F. D'Amico<sup>2,3</sup>, G. Sciarra<sup>3</sup>, G. Cristiano<sup>4</sup>, M. Cavo<sup>4,5</sup>, S. Turrone<sup>3</sup>, A. Curti<sup>5</sup>

<sup>1</sup>Institute of Hematology "Seràgnoli"; <sup>2</sup>Microbiomics Unit, Department of Medical and Surgical Sciences, University of Bologna; <sup>3</sup>Unit of Microbiome Science and Biotechnology, Department of Pharmacy and Biotechnology, University of Bologna; <sup>4</sup>Experimental, Diagnostic and Specialty Medicine - DIMES, University of Bologna; <sup>5</sup>IRCCS Azienda Ospedaliero-Universitaria di Bologna, Institute of Hematology "Seràgnoli", Italy

**Introduction:** Several studies have suggested that the gut microbiome may contribute to the onset and progression of certain malignancies and influence the therapeutic response. However, most of the studies in hematologic malignancy patients have focused on the transplant setting and related complications, such as GvHD. Here, we profiled the gut microbiome in patients with acute myeloid leukemia (AML) and evaluated its relationship to clinical parameters, including hematologic recovery.

**Methods:** Stool samples were obtained from 26 AML patients before the initiation of induction therapy consisting of 7+3 (4%), 7+3 with other therapies (27%), FLAI scheme (54%), or demethylating agents (4%). Clinical characteristics and treatment outcomes were collected. The fecal microbiota was profiled by sequencing of the 16S rRNA gene. Alpha diversity was assessed using Chao1, Faith, ASV count, Shannon, and inverse Simpson indices. Beta diversity was estimated by computing UniFrac distances. Associations analysis were sought using the random forest machine learning technique. Taxa selected ( $p < 0.01$ ) were subjected to subsequent non-parametric inferential testing.

**Results:** There was no significant correlation between the level of microbiome diversity and age, sex, ELN risk category, survival, and disease-free survival. Conversely, we observed a positive association between alpha diversity and hematologic recovery. We evaluated absolute neutrophil count (ANC), platelet (PLT), and lymphocyte (ALC) recovery at 15, 21 and 28 days after induction therapy and before consolidation (CC). Among blood recovery parameters, ANC<sub>28</sub> and PLT<sub>28</sub> were positively associated with alpha diversity. In particular, patients with complete platelet recovery at 28 days showed higher diversity for all inspected indices ( $p < 0.05$ ). On the other hand, alpha diversity correlated inversely with BM-blast ( $p < 0.05$ ) (Figure 1a). ANC<sub>28</sub> and PLT<sub>28</sub> were also associated with beta diversity ( $p < 0.05$ ) (Figure 1b). The genus *Blautia* was among the most frequently associated with the considered clinical variables, being significantly overabundant in recovers for ALC<sub>15</sub>, ALC<sub>21</sub>, ALC<sub>28</sub>, and PLT<sub>28</sub> ( $p < 0.05$ ) (Figure 1c). Other positive associations were found between *Faecalibacterium* and ANC<sub>28</sub>, PLT<sub>28</sub>, and complete remission ( $p < 0.05$ ), as well as between

the *Lachnospiraceae* family and ALC<sub>21</sub> and PLT<sub>28</sub> ( $p < 0.05$ ). Negative associations included those between *Faecalibacterium* and BM-blast and PMN<sub>CC</sub>, *Anaerostipes* and BM-blast, and *Lachnospiraceae* and ferritin ( $p < 0.05$ ).

**Conclusions:** Despite the relatively small sample size, our results suggest that gut microbiome signatures could be predictive of hematologic recovery following induction therapy and therefore potentially helpful in predicting future complications in these vulnerable AML patients. Manipulating the gut microbiota could be a promising adjuvant treatment for AML but additional studies in larger cohorts are warranted, including exploration of the underlying mechanisms.

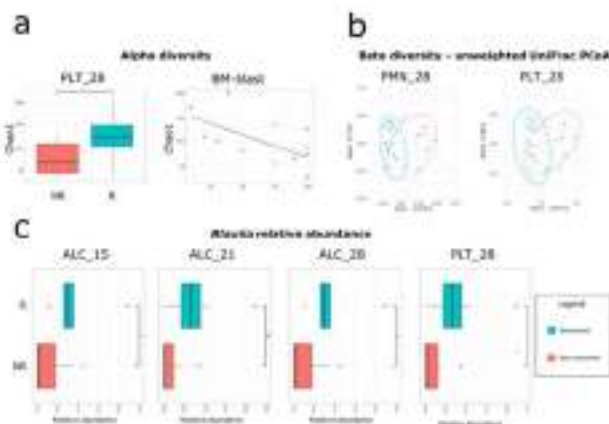

**Figure 1.** Relationship between microbiota parameters and blood recovery in patients with acute myeloid leukemia. a. The Chao1 index of alpha diversity in relation to complete platelet recovery at 28 days (PLT<sub>28</sub>; R = Recovered) and the percentage of blast cells in the bone marrow (BM-blast). b. Beta diversity estimated using the unweighted UniFrac distance in relation to polymorphonuclear leukocyte recovery at 28 days (PMN<sub>28</sub>) and PLT<sub>28</sub>; both associations were statistically significant according to the permuted multivariate variance test (adonis,  $p < 0.05$ ). c. Association between relative abundance of the genus *Blautia* and recovery of absolute lymphocyte counts at 21 and 28 days (ALC<sub>21</sub> and ALC<sub>28</sub>, respectively) and PLT<sub>28</sub>.

## P27

ABSTRACT WITHDRAWN

## P28

### NGS REVEALED CS-AML MUTATIONS AS A PUTATIVE NEGATIVE PROGNOSTIC FACTOR IN UNFIT AML PATIENTS TREATED WITH HMA AND VENETOCLAX

C. Vetro<sup>1</sup>, V. Randazzo<sup>2</sup>, C. Maugeri<sup>1</sup>, M.S. Parisi<sup>1</sup>, E. Mauro<sup>1</sup>, P.F. Fiumara<sup>1</sup>, I. Dulcamare<sup>1</sup>, A. Duminuco<sup>3</sup>, G.A.M. Palumbo<sup>1,3</sup>, D. Salemi<sup>2</sup>, A. Santoro<sup>2</sup>, F. Di Raimondo<sup>1</sup>

<sup>1</sup>Division of Haematology, A.O.U. Policlinico "G.Rodolico" - S. Marco, Catania; <sup>2</sup>Division of Hematology & Bone Marrow Transplantation, Ospedali Riuniti Villa Sofia-Cervello, Palermo; <sup>3</sup>Postgraduate School of Hematology, University of Catania, Italy

**Introduction:** Venetoclax (VEN) in combination with hypomethylating agents (HMA) (azacitidine -AZA- or decitabine -DEC-) has emerged for the first-line treatment of unfit adult acute myeloid leukemia (AML). High response rates and durable remissions are typically associated with NPM1 or IDH2 mutations, while activating signaling pathways, such as FLT3 or RAS, or TP53 relate to primary or adaptive resistance. With the present work, we aimed at primarily validate the impact of next-generation sequencing (NGS) data on a real-life setting.

**Methods:** 19 patients (pts) from our cohort of 44 pts (abstract n.135 submitted) has been evaluated for NGS analysis, performed with "ONCOMINE MYELOID RESEARCH ASSAY THERMOFISHER" procedures. Pts were treated with AZA 75 mg/m<sup>2</sup> days 1-7 or DEC 20 mg/m<sup>2</sup> days 1-5. VEN was given orally 400 mg/die, with initial ramp-

up, starting the same day of HMA. Dose equivalency related to antifungal prophylaxis (AP) was applied. Each cycle consisted of 28 days. In case of complete remission (CR) with incomplete hematological recovery (CRi) or morphologically leukemia-free state (MLFS), after completion of Cycle 1, VEN was interrupted until neutrophils (N)  $\geq 500/\mu\text{L}$  (wash-out time) and subsequent cycles delayed. At subsequent cycles, in case of previous treatment interruption, VEN was administered for 21 days or less depending on an earlier occurrence of neutropenia (N  $< 500/\mu\text{L}$ ). Wash-out up to hematological recovery was applied also at subsequent cycles.

**Results:** This cohort has been enrolled from February 2020 to January 2021 and consisted of 19 pts treated with VEN combined with AZA (11 pts, 60%) or DEC (8, 40%) at the University Hospital of Catania. Median follow-up was 11.4 months (range 0.5-22.2). 2 pts (10%) did not complete the first cycle due to adverse events. 14 pts (75%) showed a response to treatment (either CR, CRi or MLFS) while 3 patients were resistant. All of them were studied with NGS. Detected mutations are showed in figure 1. Noteworthy, no NPM1 mutations have been detected in this setting. Cytogenetic risk per se was not related with response to treatment. ELN risk seemed to relate with best achieved response (71% response rate for intermediate risk vs 28.6% in high-risk group,  $p=0.046$ , chi square test). CS-AML mutations, i.e. chromatin and spliceosome mutations (Caprioli *et al.*, 2021), did not relate with response to treatment. Moreover, ELN risk did not relate with disease-free survival (DFS), accounting responding patients, while occurrence of CS-AML mutations showed a trend to lower DFS (not reached median vs 6 months,  $p=0.08$ ). Median overall survival (OS) was 8.5 months. OS did not differ based on cytogenetic risk and ELN risk stratification. A trend to lower OS was seen in patients with CS-AML mutations (median not reached vs 7 months).

**Conclusion:** NGS data are suggestive of a role of CS-AML mutations in response to treatment of AML patients treated with combined HMAs and VEN. A validation on a larger subset is needed.

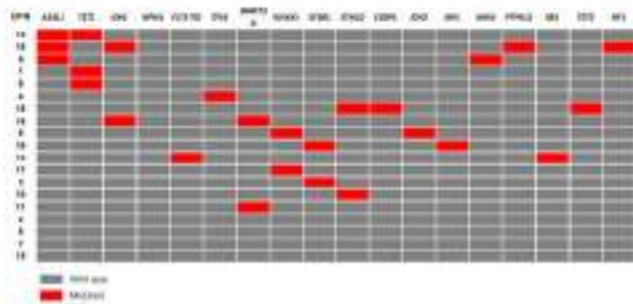

Figure 1.

**P29**

**EFFICACY AND SAFETY OF THE BNT162B2 MRNA COVID-19 VACCINE IN PATIENTS WITH ACUTE MYELOID LEUKEMIA**

S. Sciabiolacci<sup>1</sup>, G. Perta<sup>1</sup>, V. Cardinali<sup>1</sup>, S. Bozza<sup>2</sup>, L. Brunetti<sup>1</sup>, P. Bondi<sup>2</sup>, A. Graziani<sup>2</sup>, B. Falini<sup>1</sup>, I. Gionfriddo<sup>1</sup>, A. Mencacci<sup>2</sup>, M.P. Martelli<sup>1</sup>

<sup>1</sup>Institute of Haematology, Centro Ricerche Emato-Oncologiche (CREO), “Santa Maria Della Misericordia” Hospital; <sup>2</sup>Department of Medicine and Surgery, Microbiology and Clinical Microbiology, “Santa Maria Della Misericordia” Hospital, Italy

**Introduction:** Patients with hematological malignancies appear to be at higher risk for severe, potentially life-threatening, illness related to SARS-CoV-2 infection compared with the general population. This is of particular concern for patients with acute myeloid leukemia (AML), more prone to developing infections due to their usually long-lasting immunodeficiency related to the malignancy itself and anticancer treatments. Furthermore, AML presents at a median age of 65–70 years, increasing the risk of COVID-19 complications. The introduction of safe

and effective prophylactic vaccines was urgently needed to contain the pandemic. Data regarding the efficacy of these vaccines in AML patients are not available. Here we evaluated efficacy and safety of the BNT162b2 mRNA COVID-19 vaccine in patients with AML.

**Methods:** Patients and control subjects (caregivers) received 2 vaccine doses and blood samples were collected 3 weeks to 6 months after the administration of the second dose. Antibody titers were measured by LIAISON SARS-CoV-2 TrimericS IgG (DiaSorin) and NeutraLISA test (EUROIMMUN); cell-mediated immune response was detected through Interferon Gamma Release Assay (SARS-CoV-2 IGRA ELISA, EUROIMMUN). The primary endpoints were to determine the proportion of subjects acquiring specific anti-Spike IgG antibodies, the evaluation of the neutralizing activity and the detection of IFN- $\gamma$  produced by human lymphocytes in response to SARS-CoV-2 antigens.

**Results:** A total of 40 patients with AML and 20 control subjects were included. Median age was 72 yrs (IQR, 33.0-85.0) for AML patients, vs 53 yrs (IQR, 28.0-78.0) for control subjects. 25 patients (62%) were on active therapy (8 intensive chemotherapy (IC), 14 venetoclax-based regimen, 1 azacitidine, 2 experimental therapies); 14 patients (35%) were off-therapy (10 in complete remission, 4 with progressive disease). SARS-CoV-2 anti-S IgG and neutralizing antibodies were detected in 30 (75%) and 15 (37%) AML patients, respectively (vs 95% and 85% of control group) (Figure 1); the cell-mediated immune response was detected in 13 (32%) patients (vs 95% of control subjects). Strikingly, the immune response rate in terms of anti-Spike IgG antibodies resulted high both in patients on active treatment with IC (63%) and in patients treated with venetoclax-based regimen (78%). Nevertheless, neutralizing activity and cell-mediated responses were considerably lower (less than 25% of patients).

**Conclusion:** 75% of patients with AML showed SARS-CoV-2 anti-S IgG in contrast with a lower rate of cell-mediated responses, detected in the 32% of subjects; only in the 25% (10 patients) the two immune responses were both present. Interestingly, cell-mediated response was detectable only in patients in complete or partial remission, regardless of being on treatment or not. Finally, we demonstrated the absolute safety profile of BNT162b2 mRNA COVID-19 vaccine in patients with AML, observing only mild local reactions.

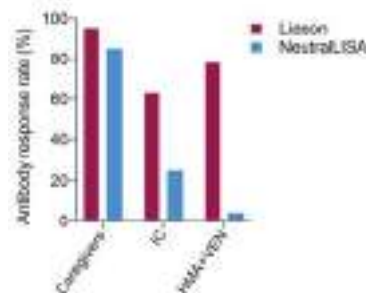

Figure 1.

**P30**

**SAFETY AND EFFICACY OF COMBINED HMAs AND VENETOCLAX AS FIRST LINE TREATMENT IN UNFIT AML PATIENTS**

C. Vetro<sup>1</sup>, C. Maugeri<sup>1</sup>, M.S. Parisi<sup>1</sup>, L. Gozzo Gozzo<sup>2</sup>, E. Mauro<sup>1</sup>, P.F. Fiumara<sup>1</sup>, I. Dulcamare<sup>1</sup>, A. Duminuco<sup>3</sup>, G.A.M. Palumbo<sup>1,3</sup>, S. Brancati<sup>2</sup>, L. Longo<sup>2</sup>, D.C. Vitale<sup>2</sup>, A. Santoro<sup>4</sup>, F. Drago<sup>2</sup>, F. Di Raimondo<sup>1</sup>

<sup>1</sup>Division of Haematology, A.O.U. Policlinico “G.Rodolico” - S.Marco, Catania; <sup>2</sup>Clinical Pharmacology Unit/Regional Pharmacovigilance Centre, A.O.U. Policlinico “G.Rodolico” - S.Marco, Catania; <sup>3</sup>Postgraduate School of Hematology, University of Catania; <sup>4</sup>Division of Hematology & Bone Marrow Transplantation, Ospedali Riuniti Villa Sofia-Cervello, Palermo, Italy

**Introduction:** Venetoclax (VEN) has been introduced, combined with

hypomethylating agents (HMA) (azacytidine -AZA- or decitabine -DEC), for the first-line treatment of unfit adult acute myeloid leukemia (AML). Although widely used, no data exist on safety of treatment washout, once remission is achieved, in order to let hematological recovery. The aim of this analysis is to address this question.

Table 1.

Characteristic		
Age, years, median (range)	72,2	47-86
	number	percentage
	(n)	(%)
<b>AML type</b>		
De novo	25	57
secondary to MDS	9	20
secondary to MDS/MPN	3	7
Myeloid blast crisis from previous MPN	5	11
Therapy-related	1	2
Myeloid sarcoma	1	2
<b>Performance status (ECOG)</b>		
0	0	0
1	18	41
2	3	7
3	7	16
4	16	36
<b>Criterion for unfitness</b>		
cardiac comorbidity	2	5
hepatic dysfunction	2	5
uncontrolled infections	14	32
peptic ulcers	2	5
older than 75 years	11	25
physician choice	13	30
<b>Citogenetic risk</b>		
Favorable	0	0
Intermediate	30	68
Poor	6	14
Failed	4	9
missing	4	9
<b>Mutations</b>		
NPM1 without FLT3-ITD	5	11
FLT3-ITD without NPM1	2	5
NPM1 with FLT3-ITD	1	2
NPM1 w.o. and FLT3-ITD negative	36	82
<b>Antifungal prophylaxis</b>		
posaconazole	5	11
voriconazole	1	2
fluconazole	10	23
caspofungin	5	11
no prophylaxis	23	52

**Methods:** Patients (pts) were treated with AZA 75 mg/m<sup>2</sup> days 1-7 or DEC 20 mg/m<sup>2</sup> days 1-5. VEN was given orally 400 mg/die, with initial ramp-up, starting the same day of HMA. Dose equivalency related to antifungal prophylaxis (AP) was applied. Each cycle consisted of 28 days. In case of complete remission (CR) with incomplete hematological recovery (CRi) or morphological leukemia-free state (MLFS), after completion of cycle 1, VEN was interrupted until neutrophils (N)  $\geq$  500/ $\mu$ L (washout time) and subsequent cycles delayed. At subsequent cycles, in case of previous treatment interruption, VEN was administered for 21 days or less depending on an earlier occurrence of neutropenia (N < 500/ $\mu$ L). Washout up to hematological recovery was applied also at subsequent cycles.

**Results:** From May 2019 to November 2021, 44 pts were treated with VEN combined with AZA (31 pts, 70%) or DEC (13, 30%) at the University Hospital of Catania (Table 1). Median follow-up was 11.4 months (range 0.5-22.2). 6 pts (14%) did not complete the first cycle due to adverse events, 2 dropped out cause persisting nausea and vomiting and 4 died during the first cycle (1 cause cerebral hemorrhage, 3 septic shock, 1 myocardial infarction). 21 (48%) pts received AP. Neutropenic fever (NF) occurred in 6 out of 23 (26%) pts without AP and 12

out of 21 (57%) pts receiving AP (p=0.065). These data were independent from type of antifungal. 38 pts (86%) were assessed for treatment response at end of first cycle. CR was reached in 3 out of 38 pts (8%), CRi in 8 (21%), MLFS in 10 (26%), partial remission (PR) in 5 (13%) and stable disease (SD) in 12 (32%). All pts in PR and 1 patient with SD reached CR at second cycle. Among the 27 responding pts, 7 (26%) relapsed and 5 died cause NF (20%). Pts pursuing treatment received a median of 5 cycles (range 2-16). Overall response rate (ORR) did not differ based on HMA (71% vs 77% in AZA and DEC groups, respectively, p=0.7). Regarding responding pts, average treatment and washout days, calculated from the various cycles done by patients, were 20 $\pm$ 4 and 20 $\pm$ 25, respectively, did not differ based on HMA and did not relate with disease-free survival (DFS) (HR 0.89; 95%CI 0.7-1.1; HR 0.98; 95%CI 0.9-1.1, respectively, Cox regression). Median overall survival was 8 months and was not influenced by type of HMA, AP, occurrence of NF, comorbidity index and washout days. CR state has been related with longer OS compared to treatment failure (median 15 $\pm$ 4.7 months vs 3 $\pm$ 0.3; p<0.0001).

**Conclusion:** We found that “washout strategy” seems to be a safe approach that did not worsen DFS.

### P31

#### GILTERITINIB IN RELAPSED/REFRACTORY FLT3-MUTATED AML: AN ITALIAN MULTICENTER REAL-WORLD EXPERIENCE

L. Brunetti<sup>1,2</sup>, S. Sciabiolacci<sup>3</sup>, V. Cardinali<sup>3,4</sup>, D. Capelli<sup>2</sup>, D. Menotti<sup>2</sup>, M.S. Parisi<sup>5</sup>, C. Maugeri<sup>5</sup>, E. Mauro<sup>5</sup>, A. Condorelli<sup>6</sup>, M. Rondoni<sup>7</sup>, F. Grimaldi<sup>8</sup>, A. Olivieri<sup>1,2</sup>, C. Vetro<sup>5</sup>, F. Saraceni<sup>2</sup>, M.P. Martelli<sup>3,4</sup>

<sup>1</sup>Università Politecnica delle Marche; <sup>2</sup>A.O.U. Ospedali Riuniti Ancona; <sup>3</sup>Università degli Studi di Perugia; <sup>4</sup>Ospedale S. Maria della Misericordia; <sup>5</sup>A.O.U. Policlinico G. Rodolico - S. Marco; <sup>6</sup>Università di Catania; <sup>7</sup>AUSL Romagna; <sup>8</sup>Università Federico II, Italy

**Introduction:** Relapsed/refractory (R/R) FLT3-mutated acute myeloid leukemia (AML) has poor prognosis with 2-years overall survival (OS) below 20%. Gilteritinib, a second-generation FLT3 inhibitor, led to a significant OS benefit over conventional treatment in R/R FLT3-mutated patients in a phase III study. Therefore, gilteritinib has been approved as monotherapy for R/R FLT3-mutated AML. However, a formal validation of the safety and efficacy of gilteritinib in the real-world setting is still missing.

**Methods:** In this retrospective, multicenter, real-world experience, we included data of 33 R/R FLT3-mutated AML patients treated with gilteritinib at 5 Italian institutions. To categorize the quality of responses, ELN 2017 criteria for CR, CRi, PR, stable disease (SD) and progressive disease (PD) were applied. Patients never achieving CR/CRi/PR/SD or dead before response assessment were considered treatment failures and included in the analysis. MRD was studied by qPCR (NPM1-positive) or by FACS (NPM1-negative patients). Toxicities were recorded according to the CTCAE 5.0.

**Results:** Patient characteristics are summarized in Table 1. Between October 2019 and November 2021, 33 patients were treated with gilteritinib 120 mg/day in 28-day cycles. Median age was 69 (range 44-81) and median ECOG performance status score (PS) was 1 (range 0-4). The median number of previous treatments was 2 (range 2-4). Most patients (76%) had received an anthracycline-containing regimen and 17 (52%) were previously treated with midostaurin. The median follow-up was 6 months, with a median number of cycles administered of 3 (range 1-19). At the time of censoring, 10 (30%) patients were still on treatment. Reason for permanent discontinuation were death in 6 (18%) and relapse/progression in 10 (30%) patients. 7 patients proceeded to bone marrow transplant (21%). 30-day mortality was 18% (6 patients) due to sepsis/febrile neutropenia (4 patients), cerebral hemorrhage (1 patient) and disease progression (1 patient). 4 out of 6 patients who experienced early-death had ECOG PS  $\geq$  3 at baseline. The most frequent grade (G) 3-4 adverse event was febrile neutropenia, recorded in 8 (24%) patients. Elevation of liver aminotransferases was reported in 5 patients (2 G3, 2 G2, 1 G1). No patient experienced QTc interval  $\geq$  500ms. No differentiation syn-

drome was recorded. Dose reduction was necessary in two patients. Dosage was escalated to 200 mg/day in two patients with no benefit on the quality of response. CR was achieved in 6 (18%) patients, while composite CR (CR/CRi) in 14 (42%). MRD-negative CR/CRi rate was 9% (3 patients).

**Conclusions:** In this real-world experience conducted on R/R FLT3-mutated AML patients, single agent gilteritinib resulted in response rates consistent with those reported in clinical trials. Drug-related adverse events were manageable overall, with the caveat of high early-death rate observed in patients with poor PS at baseline.

Table 1.

Characteristic	All patients (N = 33)
Age - Median (range)	60 (44-81)
Female sex - no. (%)	16 (48)
ECOG PS - Median (range)	1 (0-4)
Cytogenetic risk - no (%)	
- Favorable	0 (0)
- Intermediate	30 (91)
- Unfavorable	3 (9)
Previous therapy for AML - no. (%)	
- Anthracycline	25 (76)
- FLT3 inhibitor	17 (52)
- HSCTs	3 (9)
FLT3 mutation subtype - no. (%)	
- ITD	28 (85)
- TKD	2 (6)
- ITD and TKD	3 (9)
ITD ratio (28 patients) - Median (range)	0.47 (0.05-11)
NPM1-mutated - no (%)	16 (48)
Hospitalization at cycle 1 - no (%)	14 (42)
Asole prophylaxis - no (%)	2 (6)

**P32**

**COVID19 IN ACUTE LEUKEMIAS: A REAL- LIFE PERSPECTIVE**

M.G. Rascato<sup>1,2</sup>, F. Grimaldi<sup>1</sup>, S. Vitiello<sup>1</sup>, M. DeSimone<sup>2</sup>, A. Gravetti<sup>2</sup>, C. Copia<sup>2</sup>, F. Pane<sup>1</sup>, F. Ferrara<sup>2</sup>

<sup>1</sup>Dipartimento di Medicina Interna e Chirurgia, AOU Federico II; <sup>2</sup>Dipartimento di Ematologia, AORN A.Cardarelli, Italy

**Introduction:** In 2020 COVID19 was declared a new pandemic virus. Since then, major concerns have been expressed regarding its impact on hematological patients treatment and mortality. Few data are available for SarsCOV-2 and acute leukemias; here we present a small real-life cohort of patients from a high-incidence region.

**Methods:** From December 2020, 20 patients received diagnosis of acute leukemia and COVID19, confirmed by molecular transnasal swab. Among infected patients, 10 were acute myeloid leukemia (AML), 6 were acute Lymphoid leukemia (ALL), and 4 acute promyelocytic leukemia (APL); male/female 11/9, median age 50 (21-69). Concomitant comorbidities were present in 12 (60%), with a median number of medication of 2 (range 1-3).

**Results:** In 17 patients (85%) COVID19 was diagnosed at the end of a cycle of chemotherapy; 2 (10%) patients received concurrent diagnosis of AML and COVID19; 1 patient (5%) received diagnosis of COVID19 during treatment with TKI. Interstitial pneumonia was confirmed in 9 patients (5 AML/2 APL/2 ALL) by CT scan; supportive measures included oxygen in all patients, with need of Non Invasive Positive Pressure Ventilation for 2 of them, and transfer to ICU unit and intubation for 4 of them (2 AML/2 APL). All intubated patients died of interstitial pneumonia. The patient on TKI continued treatment without interruption. 3 patients with persistent swab positivity started treatment with targeted agents (2 venetoclax; 1 gilteritinib). Intensive chemotherapy was restarted in 12 patients (10 AML/2 ALL); in ALL patients, treatment was restarted despite a low COVID19 positivity. In evaluable patients (16/20), median time to swab negativization was of 39 days (11-60), with no impact on type of diagnosis (AML vs ALL, 39 vs 38 days, p=0.44), and significant impact in type of treatment (Intensive vs Non-intensive, 42 vs 14 days, p=0.0009). Only one atypical extra-hematological toxicity with pleural effusion, responsive to steroids and drainage, was observed.

**Conclusions:** SARS-CoV-2 infection is associated with worst outcome in patients who develop interstitial pneumonia, with an observed

death rate of 20%. In our cohort, 2 of deaths occurred in APL. This suggests that treatment intensity do not necessarily correlate with pneumonia severity. However swab negativization time suggest to avoid intensive therapy when a treatment need to be started due to disease progression.

**P33**

**VENETOCLAX IN ASSOCIATION WITH HYPOMETHYLATING AGENTS (HMA) INDUCES RAPID CLEARANCE OF NPM1 MUTANT TRANSCRIPT IN A CASE OF MISURABLE RESIDUAL DISEASE (MRD) POSITIVE NPM1-AML AND IN A CASE OF RELAPSED/REFRACTORY (R/R) DISEASE**

M. Giaimo<sup>1</sup>, B. Cambo<sup>1</sup>, L. Prezioso<sup>1</sup>, A. Rinaldi<sup>1</sup>, A.B. Dalla Palma<sup>1</sup>, D. Vallisa<sup>2</sup>

<sup>1</sup>U.O.C. Ematologia e Centro Trapianti Midollo Osseo, Azienda Ospedaliero-Universitaria di Parma; <sup>2</sup>U.O. Ematologia e Centro Trapianti Midollo Osseo, Ospedale G. da Saliceto di Piacenza, Italy

**Introduction:** NPM1 mutation is a disease-defining event in AML with favorable prognostic features in absence of FLT3-ITD co-mutation or with FLT3-ITD low allelic ratio (AR)1-3. Nevertheless, AML relapse can occur and represents an unmet need in patients ineligible for intensive chemotherapy (IC). Furthermore in transplant-eligible patients, a bridge approach with less toxicity profile than IC is auspicious. Recent data support exceptional sensitivity to BCL2 inhibition by Venetoclax (VEN) in NPM1 AML4,5. We report two new cases of NPM1 AML who experienced a rapid NPM1 transcript clearance with a Venetoclax-based chemo-free approach as rescue strategy.

**Methods:** Patient 1: in Oct 2020 a 68y.o. man was diagnosed with 46,XY NPM1+ AML and FLT3-TKD co-mutation. He received D3A7+Midostaurine induction and achieved CR with NPM1 ratio of 0.77%. Because of severe toxicity, the patient was not a candidate to other IC. After 1 month MRD persistence was confirmed and he started Azacitidine (AZA) 75 mg/m<sup>2</sup> SC day1-7 with VEN 100mg PO day1-14. Patient 2: A 66y.o. man was referred to the hematologist in Jan 2020 and was diagnosed with 46,XY NPM1+ AML and FLT3-ITD mutation. He was treated with D3A7+Midostaurine induction and 2 courses of HD-AraC+Midostaurin achieving CR, so he was referred to our Center for evaluation of HSCT indication. CR with MRD negativity was confirmed, but he was considered temporarily ineligible to transplant procedure because of heart failure due to severe mitral insufficiency. He started Midostaurine as maintenance and underwent surgical valvuloplasty. In Jan 2021 disease relapse occurred (88% BM blasts). Gilteritinib was started as salvage therapy and led to blasts reduction up to 23% without hematological recovery. AZA was associated with Gilteritinib in an off-label setting: after 2 courses no significant further BM blasts reduction was obtained: FLT3-ITD was undetectable, but NPM1 transcript was still present (ratio >100%). Third line salvage strategy with AZA75mg/m<sup>2</sup> SC day1-7 with VEN100 mg PO day1-21 was started.

Table 1.

**Results:** Patient 1 after 2 courses achieved MRD negativity. After 8 cycles Venetoclax dose was reduced by 50% because of persistent G4 neutropenia. After 11 cycles patient is still in CR with MRD-. Patient 2 experienced hematological recovery and BM blasts clearance after 2

cycles, with rapid reduction of NPM1 mutated transcript (68%). At the last evaluation, the patient received a total of 3 courses and he is candidate to HSCT.

**Conclusions:** Venetoclax is an oral BCL2 inhibitor that has shown efficacy as first-line treatment with HMA in elderly patients ineligible for IC. Recent evidence indicates that HMA+VEN is particularly effective in patients harboring NPM1 mutation. We described two NPM1+ patients who experienced rapid response to low dose Venetoclax-based approach in a salvage setting. More data occurs to confirm the role of HMA+VEN in R/R AML but NPM1 mutated could represent a selected target population.

## Chronic Lymphocytic Leukemia and Chronic Lymphoproliferative Disorders

### P34

#### COVID-19 PANDEMIC IMPACT ON CHRONIC LYMPHOCYTIC LEUKEMIA (CLL) PATIENTS' PREFERENCES TOWARDS THERAPIES: THE ITALIAN EXPERIENCE (CHOICE STUDY)

S. Molica<sup>1</sup>, L. Laurenti<sup>2</sup>, P. Ghia<sup>3</sup>, M. Coscia<sup>4</sup>, A. Cuneo<sup>5</sup>, G. Gaidano<sup>6</sup>, F.R. Mauro<sup>7</sup>, A.M. Frustaci<sup>8</sup>, D. Vallisa<sup>9</sup>, F. Pane<sup>10</sup>, G. Gualberti<sup>11</sup>, E. Iannella<sup>11</sup>, P. Finsinger<sup>11</sup>, M. Caira<sup>11</sup>, P. Sportoletti<sup>12</sup>

<sup>1</sup>Azienda Ospedaliera Pugliese Ciaccio, Ematologia, Catanzaro; <sup>2</sup>Fondazione Policlinico Universitario A Gemelli, IRCCS Dip. Diagnostica per immagini, Radioterapia oncologica ed Ematologia, Roma; <sup>3</sup>Università Vita-Salute San Raffaele and IRCCS Ospedale San Raffaele, Strategic Research Program on CLL, Milano; <sup>4</sup>Dipartimento di Biotecnologie Molecolari e Scienze per la Salute, Università di Torino e S.C. Ematologia U, A.O.U. Città della Salute e della Scienza di Torino; <sup>5</sup>AOU Ferrara – Dip. Scienze Mediche, Università di Ferrara; <sup>6</sup>SCDU Ematologia, Dip. Medicina Traslazionale, Università del Piemonte Orientale, Novara; <sup>7</sup>Dipartimento di Medicina Traslazionale e di Precisione, Università Sapienza, Roma; <sup>8</sup>ASST GOM NIGUARDA – SC Ematologia, Milano; <sup>9</sup>AUSL Piacenza -Ospedale Guglielmo da Saliceto-Dipartimento Oncoematologico UO Ematologia Centro Trapianti; <sup>10</sup>AOU Federico II, Dip Medicina Clin e Chirurgia, UOC Ematologia e Trapianti di Midollo, Napoli; <sup>11</sup>AbbVie Srl; <sup>12</sup>Department of Medicine and Surgery, Institute of Hematology and Center for Hemato-Oncological Research, Ospedale S. Maria della Misericordia, Perugia, Italy

**Introduction:** The CHOICE study was primarily designed to capture CLL patients' (pts) preferences towards different treatment attributes through a Discrete Choice Experiment (DCE) in Italy. This study was carried out in the period Feb-Jul 2020, during the 1st wave of COVID19 pandemic, and provides an insight of the pts' perception about treatments available in CLL (1-2).

**Methods:** This cross-sectional multicenter observational study enrolled, WATCH&WAIT (W&W) or TREATED CLL pts (~50% each, controlled at site level). Exclusion criteria were inability to take oral drugs, cognitive disorders that could impair questionnaire's comprehension and concomitant therapy for other malignancies. Pts were asked to fill in aDCE Questionnaire, composed of 9/10 blocks (for W&W/TREATED respectively) each composed of 8 comparisons between 2 profiles with the following attributes: treatment and relevant duration, PFS, risk of infection, risk of organ damage, risk of diarrhea (levels specified in Figure 1). Each pt was centrally assigned to 1 block of 8 comparisons. Pts could ask questionnaire explanations to the medical staff, but they were asked to self-complete it.

**Results:** 401 pts from 16 centers were enrolled in the study, 199 W&W and 198 TREATED pts completed the questionnaire and were considered evaluable. Main pts' characteristics are shown in Table 1. Of the 198 TREATED pts, 73.7% were ON-treatment (30.8% 1st-line, 69.2% further lines) while 26.3% were OFF-treatment. W&W pts rated as the most attribute of treatment important the 'Possibility of infections' (relative importance, RI=36.2%), followed by 'Treatment and Relevant duration' (RI=28.0%) and 'PFS' (RI=16.9%). (Figure 1A). When stratifying pts by geography, W&W pts from the North regions (more impacted during the 1st wave) rated as most important the 'Treatment and Relevant duration' (RI=40.3%) followed by the 'Possibility of infection' (RI=27.2%). Pts from the Center-South regions rated as most important the 'Possibility of infection' (RI=43.4%) followed by the 'Possible occurrence of Organ damage' (RI=21.6%). TREATED pts gave more importance to the 'Treatment and relevant duration' (RI =33.3%) followed by the 'Possibility of infections' (RI =28.8%) (Figure 1B) with no difference between patients from the north and center-south areas.

**Conclusions:** Unlike other DCE studies available in the current literature (1-2), the results of the CHOICE study may have been influenced by the pandemic. While the essential attribute in pre-pandemic DCE studies was the PFS, the most important attribute in DCE studies conducted during

the first pandemic wave was represented by the infection concerns. Hospital access constraints, the necessity for personal protective equipment, and social distance may have influenced patient responses.

**Table 1. Main Clinical Characteristics.**

		Treated	Not	
Age	Mean (SD)	68.8 (10.2)	67.8 (10.2)	
	Median (IQR)	68.8 (61.8-75.8)	67.8 (61.8-75.8)	
Sex	Male	59.2% (101/169)	51.5% (102/198)	
	Female	40.8% (68/169)	48.5% (96/198)	
Education	Primary school	34.3% (58/169)	27.8% (55/198)	
	Secondary school	22.5% (38/169)	26.3% (52/198)	
	High school	22.2% (37/169)	26.3% (52/198)	
University	University	20.7% (35/169)	23.7% (47/198)	
	Postgrad	19.2% (32/169)	16.2% (32/198)	
Occupation	Worker (part-time / full-time)	22.5% (38/169)	24.3% (48/198)	
	Retired	77.5% (131/169)	75.7% (150/198)	
BMI	Mean (SD)	23.2 (4.3)	23.2 (4.3)	
	Median (IQR)	23.2 (20.2-26.2)	23.2 (20.2-26.2)	
Diagnosis	Body systems involved (n)	73.2% (122/167)	77.8% (154/198)	
	Disease Duration, years	Median (IQR)	3.0 (1-7)	3.0 (2-6)
HCV	Monoclonal	25.5% (43/169)	47.5% (94/198)	
	Not monoclonal	74.5% (126/169)	52.5% (104/198)	
DLCL	Monoclonal	14.2% (24/169)	2.5% (5/198)	
	Not monoclonal	85.8% (145/169)	97.5% (193/198)	
DLCL	Monoclonal	20.7% (35/169)	11.6% (23/198)	
	Not monoclonal	79.3% (134/169)	88.4% (175/198)	
TSS	Yes	15.4% (26/169)	4.0% (8/198)	
	No	84.6% (143/169)	96.0% (190/198)	
Immunohistochemistry	At least one other clone pathology	21.9% (37/169)	20.2% (40/198)	
	Number of abnormalities	Median (IQR)	3.0 (2-4)	3.0 (2-4)
Most frequent other pathologies	Lymphoma	34.3% (58/169)	22.2% (44/198)	
	Dyslipidemia	11.8% (20/169)	13.1% (26/198)	
	Obesity	12.4% (21/169)	10.6% (21/198)	
	Diabetes	16.5% (28/169)	14.1% (28/198)	
	Other Neoplasia	12.4% (21/169)	13.7% (27/198)	
	Cardiovascular	16.6% (28/169)	16.7% (33/198)	
Type of cancer treatment	Previous Major Surgery	26.6% (45/169)	45.5% (90/198)	
	Currently treated	13.7% (23/169)	13.7% (27/198)	
	No current treatment	36.7% (61/169)	36.4% (72/198)	
	Previous treatment	30.7% (51/169)	30.7% (61/198)	
Type of cancer treatment	At least 1 previous treatment	67.4% (113/169)	66.2% (131/198)	
	N of previous treatment	Median (IQR)	1.0 (1-3)	1.0 (1-3)
	Chemotherapy (Monoclonal)	22% (37/169)	22% (44/198)	
	BA (Bendamustine/Benzalkonium)	2.9% (5/169)	2.9% (6/198)	
	FC (Flutamide/Cytosine/Fluorouracil)	2.9% (5/169)	2.9% (6/198)	
	FC (Flutamide+Cytosine/Fluorouracil)	0.6% (1/169)	0.6% (1/198)	
	Immunotherapy	0.6% (1/169)	0.6% (1/198)	
	Stem cell transplantation	0.6% (1/169)	0.6% (1/198)	
	Transfusions/Supportive	8.3% (14/169)	8.3% (17/198)	
	Other	11.8% (20/169)	11.8% (24/198)	

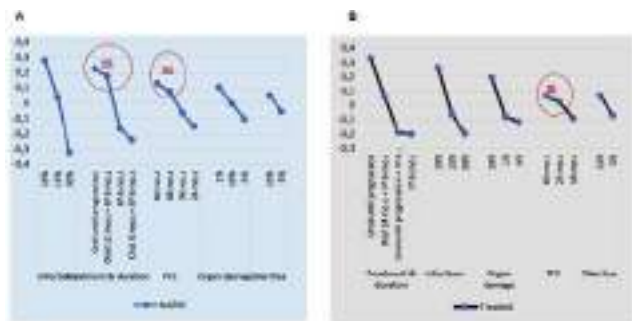

**Figure 1. Patients Preferences for the Attributes of the DCE.**

**P35**  
**NEW IN VITRO THERAPEUTIC APPROACHES TO INDUCE HAIRY CELL LUEKEMIA B LYMPHOCYTE APOPTOSIS**

F. Severin<sup>1,2</sup>, F. Frezzato<sup>1,2</sup>, A. Visentin<sup>1,2</sup>, E. Ruggeri<sup>1</sup>, N. Mouawad<sup>1</sup>, L. Martinello<sup>1</sup>, M. Facco<sup>1,2</sup>, I. Szabò<sup>3</sup>, L. Trentin<sup>1,2</sup>

<sup>1</sup>Department of Medicine, Hematology and Clinical Immunology Branch, Padua University School of Medicine; <sup>2</sup>Veneto Institute of Molecular Medicine (VIMM); <sup>3</sup>Department of Biology, University of Padua, Italy

**Introduction:** Hairy Cell Leukemia (HCL) is a B-cell malignancy accounting for about 2% of all leukemias. The V600E point mutation of BRAF is a distinctive feature of most classical forms (that is present in 95% of HCL cases). Despite all good treatments available to control the

disease, HCL is unfortunately still incurable. About 40% of HCL patients, in fact, relapse. The unmet clinical need is the discovery of new effective treatments against HCL. To this aim, we evaluated the *in vitro* efficacy of the microtubule depolymerizing agent Nocodazole and of the Kv1.3 mitochondrial potassium channel inhibitor PAPTP. Nocodazole, beside its action on cell cytoskeleton – that per se would be reason enough since in HCL the cytoskeleton is aberrantly rearranged – is a high-affinity inhibitor of different kinases, including BRAF. As far as potassium channels are concerned, the Kv1.3 has been involved in the up-regulation of BRAF itself in different cellular models resembling the same effect of mutated BRAF. Moreover, Kv1.3 inhibition increases mitochondrial ROS production thus favoring cell death. For these reasons, inhibitors of Kv1.3, e.g., PATP, could be a good candidate for the treatment of HCL, as demonstrated by our preliminary data.

**Methods:** B cells were collected from 10 HCL patients and 5 healthy subjects. HCL samples were characterized by flow cytometric evaluation of anti-CD103, anti-CD11c, anti-CD45, anti-CD25, anti-CD5 and anti-CD19. Purified cells (2x10<sup>6</sup> cells/ml) were cultured and treated with Nocodazole (16µM) and PAPTP (10µM), for 24, 48, 72h. HCL and normal B cell viability was tested by Flow Cytometry (FC) with Annexin V/PI test and by Western Blotting evaluating cleaved-PARP expression. Cell tubulin cytoskeleton was observed by confocal microscopy.

**Results:** We demonstrated that that Nocodazole significantly decreased cell viability of hairy cells from 63.50±19.29% (untreated) to 52.84±22.14% (treated) after 24h by FC. When we separately analyzed classic vs variant HCLs, we observed Nocodazole was more effective in the latter with a 50.00±33.29% of viable cells after treatment with respect to the 89.22±6.43% observed in the classic forms (data have been normalized putting equal to 100% the untreated conditions). Moreover, 24h treatment with Nocodazole is able to disrupt hairy cell tubulin cytoskeleton architecture. We also demonstrated that PAPTP administration is able to induce a significant cell death in hairy cells. In particular, viable hairy cells after 24h of 10µM PAPTP treatment are 15.17±21.33% vs the untreated condition (59.00±23.59%) FC test and PARP cleavage. Interestingly, PAPTP treatment at the same times and concentrations has no effect on healthy B lymphocytes.

**Conclusions:** The ability of Nocodazole and PAPTP to induce apoptosis in leukemic B cells, represents a starting point for the development of new therapeutic strategies in HCL. These findings also provide new hints on the importance as target of the BRAF pathways.

**P36**  
**TCR CHAINS DEEP-CHARACTERIZATION AND MOLECULAR ANALYSES HELP TO UNDERSTAND THE NATURE AND THE CLINICAL COURSE OF T GAMMA/Delta LARGE GRANULAR LYMPHOCYTE LEUKEMIA**

A. Teramo<sup>1,2</sup>, A. Binatti<sup>3</sup>, E. Ciabatti<sup>4</sup>, G. Schiavoni<sup>5</sup>, G. Tarrini<sup>4</sup>, G. Barilà<sup>1,2</sup>, G. Calabretto<sup>1,2</sup>, C. Vicenzetto<sup>1,2</sup>, V.R. Gasparini<sup>1,2</sup>, M. Facco<sup>1,2</sup>, L. Trentin<sup>1,2</sup>, S. Carraro<sup>1</sup>, I. Petrini<sup>6</sup>, R. Grossi<sup>7</sup>, N. Pisanti<sup>7</sup>, B. Falini<sup>5</sup>, E. Tiacci<sup>5</sup>, S. Galimberti<sup>4</sup>, S. Bortoluzzi<sup>3,8</sup>, G. Semenzato<sup>1,2</sup>, R. Zambello<sup>1,2</sup>

<sup>1</sup>Department of Medicine (DIMED), Hematology and Clinical Immunology Branch, Padua University School of Medicine; <sup>2</sup>Veneto Institute of Molecular Medicine (VIMM), Padua; <sup>3</sup>Department of Molecular Medicine, University of Padua, Padua; <sup>4</sup>Department of Clinical and Experimental Medicine, Section of Hematology, University of Pisa; <sup>5</sup>Department of Medicine, Section of Hematology, University of Perugia; <sup>6</sup>Department of Translational Research on New Technologies in Medicine and Surgery, University of Pisa; <sup>7</sup>Department of Informatics, University of Pisa; <sup>8</sup>CRIBI Biotechnology Centre, University of Padua, Padua, Italy

**Introduction:** Tγδ large granular lymphocyte leukemia (Tγδ LGLL) is a rare lymphoproliferative disease, representing 5% of all T-LGLL that in Europe accounts for 2-5% of chronic lymphoproliferative disorders. In comparison with the Tαβ LGLL variant, the most uncommon Tγδ LGLL has been less defined. This work pointed at characterizing Tγδ LGLL TCR clonotype pattern and at establishing correlations among STAT3/STAT5B mutations, LGL phenotype and clinical course.

**Methods:** A pilot cohort of 9 T $\gamma\delta$  LGLL patients (4 symptomatic and 5 asymptomatic) and 23 healthy controls was analyzed by next generation sequencing (NGS) for  $\gamma$  and  $\delta$  clonotype repertoire and *STAT3/STAT5B* mutations. Flow cytometer evaluation of LGL immunophenotype, *STAT3/STAT5B* Sanger sequencing and clinical features have been collected in an extended cohort (n=28) and in the pilot study group (in total n=36, 17 symptomatic and 19 asymptomatic). In these evaluations, 3 patients affected by hepatosplenic T-cell lymphoma (HSTCL) expressing TCR $\gamma\delta$  were also included for comparison.

**Results:** NGS showed that patients' T $\gamma\delta$  main clonotypes (with frequency >5%), regarding both  $\gamma$  and  $\delta$  chains, were public: they were found also in the TCR repertoire of healthy controls, although at low frequency. However, a biased use of  $\gamma$  CDR3 repertoire emerged, being the dominant clonotypes statistically more frequent in patients' repertoire than in controls (P<0.05). Consistently, among asymptomatic cases, some  $\gamma$  clonotypes shared the same CDR3 rearrangement. Concerning the V-(D)-J  $\gamma/\delta$  usage of the patients' major clones, the V $\gamma$ 9-J $\gamma$ P and V $\delta$ 2-D $\delta$ 3-J $\delta$ 1 were the combination most frequently found among asymptomatic patients, whereas they were absent in the symptomatic group, this latter being rather characterized by the most unconventional genes for peripheral blood TCR repertoire. Immunophenotype data and clinical information collected from the enlarged cohort revealed an association between V $\delta$ 2/V $\gamma$ 9 clonality and indolent course, while V $\delta$ 2/V $\gamma$ 9 negatively correlated with symptomatic disease (P<0.05). Of note, the CD28-CD45RA+CD45RO+CD62L+ phenotype was detected only in association with an indolent disease, whereas the effector phenotype CD28-CD45RA+CD45RO-CD62L- was found exclusively in the symptomatic group (P<0.05). Moreover, analysis of the *STAT* mutational profile showed that all the 7 patients with *STAT3* mutations had neutropenia associated to the CD56-/V $\delta$ 2-ve phenotype while the 3 cases with *STAT5B* mutations displayed asymptomatic clinical course and CD56/V $\delta$ 2 expression.

**Conclusions:** Through NGS analysis we found that the clonal cells in T $\gamma\delta$  LGLL patients are mainly characterized by public clonotypes but notably T $\gamma\delta$  LGLL clonotypes are differently distributed between symptomatic and asymptomatic patients. Our data also showed that discrete immunophenotypes and *STAT* mutational profiles were associated with different clinical courses, thus emphasizing their relevance for the correct management of patients with T $\gamma\delta$ -cell expansions.

### P37

#### OVERCOMING DRUG RESISTANCE IN CHRONIC LYMPHOCYtic LEUKEMIA BY DEVELOPING A CELL LINE RESISTANT TO IBRUTINIB

F. Frezzato<sup>1,2</sup>, N. Mouawad<sup>1</sup>, F. Severin<sup>1,2</sup>, E. Ruggeri<sup>1</sup>, L. Martinello<sup>1</sup>, A. Visentin<sup>1,2</sup>, E. Pagnin<sup>1</sup>, V. Trimarco<sup>1</sup>, A. Tonini<sup>1</sup>, S. Pravato<sup>1</sup>, S. Imbergamo<sup>1</sup>, A. Martinez<sup>3</sup>, L. Bonaldi<sup>3</sup>, M. Facco<sup>1,2</sup>, L. Trentin<sup>1,2</sup>

<sup>1</sup>Dipartimento di Medicina, Università degli Studi di Padova; <sup>2</sup>Istituto Veneto di Medicina Molecolare (VIMM); <sup>3</sup>Immunologia e Diagnostica Molecolare Oncologica, Istituto Oncologico Veneto, Italy

**Introduction:** The Bruton's tyrosine kinase (Btk) inhibitor Ibrutinib (Ibr) has significantly improved outcome in Chronic Lymphocytic Leukemia (CLL), achieving high efficacy even in high-risk and chemorefractory patients. However, the presence of primary or acquired resistance often leads to poor clinical outcomes. Besides Btk and PLC $\gamma$  mutations cause Ibr-resistance in 80-85% of cases, the understanding of the mechanisms leading to Ibrutinib resistance will be critical in the development of next generation therapeutic strategies to overcome the incidence of resistance. Towards the goal of overcoming this resistance, the aim of this study was the development and characterization of an Ibrutinib-resistant cell line.

**Methods:** The MEC-1 CLL cell line was cultured in IMDM medium, supplemented with antibiotics and 10% FBS, and incubated at 37°C in 5% CO<sub>2</sub> humidified atmosphere without (wild type MEC, MEC#WT) or with increasing doses of Ibrutinib (MEC#Ibr). IC<sub>50</sub> was calculated periodically to assess the acquiring of resistance in MEC#Ibr vs. MEC#WT. Subclones were derived from MEC#Ibr and clones #6 and #10 have been selected because of their higher resistance to Ibrutinib.

Western blotting for PARP cleavage was employed to assess apoptosis induction by Ibrutinib in all the cell lines under study. The four cell lines have been characterized through flow cytometry and cytogenetics. Proteomic profiles of resistant cells have been analyzed with membrane-based arrays.

**Results:** To develop the Ibrutinib-resistant cell lines, we achieved different IC<sub>50</sub> values for MEC#WT (5.14 $\mu$ M) and MEC-1 cells acquiring resistance (MEC#Ibr= 19.88 $\mu$ M; MEC#Ibr-6= 15.90 $\mu$ M; MEC#Ibr-10= 19.76 $\mu$ M), with a calculated fold resistance compared to MEC#WT of 3.87, 3.09 and 3.84, respectively. When the four cell lines were treated with 5 $\mu$ M Ibrutinib, only the MEC#WT underwent apoptosis after 72h, as opposed to MEC#Ibr and the two resistant clones, as assessed by PARP cleavage. As for the proteomic profile, in the resistant cell lines with respect to the MEC#WT we found a dysregulation of several proteins. We highlighted: i) an overall hyperactivation of the MAPK pathway, particularly MSK2-S360, MKK6-S207, MKK3-S189, MEK1/2-S217/221; ii) up-regulation of some molecules of AKT/PI3K/mTOR pathway, especially in MEC#Ibr-6; iii) down-regulation of ATF-T69/71 and c-JUN-S73, belonging to TGF- $\beta$  pathway; iv) down-regulation of SHP-1-S591 and up-regulation of SRC-Y419 of JAK/STAT pathway.

**Conclusions:** In this study we generated Ibrutinib-resistant CLL cell lines through continuous and increasing doses of Ibrutinib with the final goal to identify possible alterations in signaling pathways that make CLL cells resistant to such treatment. Particularly, we found that the MAPK pathway is highly activated in resistant cells. The establishment of this model might be useful to study molecular mechanisms leading to Ibrutinib-resistance and provide guidance on the treatment for those patients failing Ibrutinib.

### P38

#### CHRONIC LYMPHOCYtic LEUKEMIA (CLL) PATIENTS QOL: A CROSS-SECTIONAL ANALYSIS OF THE ITALIAN EXPERIENCE IN THE CHOICE STUDY DURING THE FIRST WAVE OF THE COVID-19 PANDEMIC

A. Tedeschi<sup>1</sup>, I. Innocenti<sup>2</sup>, F. Albano<sup>3</sup>, A. Gozzetti<sup>4</sup>, L. Levato<sup>5</sup>, M. Porrazzo<sup>6</sup>, G. Reda<sup>7</sup>, E. Albi<sup>8</sup>, A. Chiarenza<sup>9</sup>, G. Giuliana<sup>10</sup>, S. Malgieri<sup>10</sup>, P. Finsinger<sup>10</sup>, L. Trentin<sup>11</sup>

<sup>1</sup>SST Grande Ospedale Metropolitano Niguarda – SC Ematologia, Milano; <sup>2</sup>Fondazione Policlinico Universitario A Gemelli, IRCCS, Dip. Diagnostica per immagini, Radioterapia oncologica ed Ematologia, Roma; <sup>3</sup>Hematology, Department of Emergency and Organ Transplantation, University of Bari, Bari; <sup>4</sup>Università degli Studi di Siena, Policlinico S. Maria alle Scotte, Siena; <sup>5</sup>SOC di Ematologia - Dipartimento di Ematologia Oncologia, Azienda Ospedaliera Pugliese Ciaccio, Catanzaro; <sup>6</sup>Ematologia, Università Sapienza, Dipartimento di Medicina Traslationale e di Precisione, Roma; <sup>7</sup>U.O.C. Ematologia, Fondazione IRCCS Ca'Granda Ospedale Maggiore Policlinico di Milano, Milano; <sup>8</sup>IRCCS Ospedale San Raffaele, Strategic Research Program on CLL, Milano; <sup>9</sup>Divisione di Ematologia con Trapianto, A.O.U. Policlinico "G. Rodolico-S. Marco", Catania; <sup>10</sup>AbbVie Srl, Roma; <sup>11</sup>Divisione di Ematologia, Dipartimento di Medicina, Azienda Ospedale-Università di Padova, Padova, Italy

**Introduction:** Most Patient Reported Outcomes data currently available for CLL patients (pts) come from randomized controlled trials (1-2), hence limiting generalizability. CHOICE study investigated CLL patients' QoL and preference towards different treatment characteristics through a Discrete Choice Experiment (DCE). Due to the study timelines (Feb-Jul2020), the data offer an insight into pts perception / worries during the 1st wave of the COVID-19 pandemic in Italy.

**Methods:** This cross sectional, multi-center, observational study included CLL pts, treatment-naïve in the watch & wait period (W&W) or TREATED (1:1). Exclusion criteria were inability to take oral drugs, cognitive disorders that could impair the comprehension of the questionnaires, concomitant treatment for other malignancies. Pts completed the EQ-5D-5L, EORTC QLQ-C30 and QLQ CLL-16, as well as a DCE questionnaire in an electronic format.

**Results:** 401 pts were enrolled in Italy in 16 hematology centers (Feb-Jul20); 199 W&W and 196 TREATED pts were evaluable. Main patients' characteristics are shown in Table 1. 73.7% of TREATED pts were ON-

treatment (30.8% in 1st-line, 69.2% in further lines) and 26.3% were OFF-treatment; 55.6% were currently treated with a target therapy (Table 1).

**Table 1. Main Clinical Characteristics.**

	N	198 (100.0%)	199 (100.0%)
Age	Mean ± SD	68.4 ± 10.6	67.9 ± 10.3
Gender Male	% n/Pts	68.2% (135/ 198)	61.3% (122/ 199)
Race Caucasian	% n/Pts	99.5% (197/ 198)	100.0% (199/ 199)
Education Primary school	% n/Pts	34.8% (69/ 198)	27.6% (55/ 199)
Secondary school	% n/Pts	32.8% (65/ 198)	36.2% (72/ 199)
High school	% n/Pts	22.2% (44/ 198)	24.1% (48/ 199)
University	% n/Pts	10.1% (20/ 198)	12.1% (24/ 199)
Occupation Retired	% n/Pts	66.2% (131/ 198)	59.3% (118/ 199)
Worker (part-time -or full-time)	% n/Pts	29.3% (59/ 198)	34.2% (68/ 199)
Diagnosis Time from diagnosis, years	Median (IQR)	7.0 (4- 11)	5.0 (2- 9)
IGHV Mutated	% n/Pts	25.8% (51/ 198)	42.2% (84/ 199)
Unmutated	% n/Pts	55.6% (110/ 198)	17.1% (34/ 199)
Not evaluable	% n/Pts	18.7% (37/ 198)	40.7% (81/ 199)
del17p Mutated	% n/Pts	14.1% (28/ 198)	2.5% (5/ 199)
Unmutated	% n/Pts	60.1% (119/ 198)	51.8% (103/ 199)
Not evaluable	% n/Pts	25.8% (51/ 198)	45.7% (91/ 199)
del11q Mutated	% n/Pts	17.2% (34/ 198)	4.5% (9/ 199)
Unmutated	% n/Pts	55.6% (110/ 198)	49.2% (98/ 199)
Not evaluable	% n/Pts	27.3% (54/ 198)	46.2% (92/ 199)
TP53 Yes	% n/Pts	15.2% (30/ 198)	4.0% (8/ 199)
No	% n/Pts	58.1% (115/ 198)	36.2% (73/ 199)
Not evaluable	% n/Pts	26.8% (53/ 198)	59.3% (118/ 199)
CIRS Total CIRS Score	Median (IQR)	6.0 (4- 9)	6.0 (4- 8)
Body systems involved ≥3	% n/Pts	74.2% (147/ 198)	77.9% (155/ 199)
Most frequent comorbidities			
Hypertension	% n/Pts	54.5% (108/ 198)	52.3% (104/ 199)
Dyslipidemia	% n/Pts	11.6% (23/ 198)	13.1% (26/ 199)
Obesity	% n/Pts	12.1% (24/ 198)	15.6% (31/ 199)
Diabetes	% n/Pts	16.7% (33/ 198)	14.1% (28/ 199)
Other Neoplasia	% n/Pts	12.6% (25/ 198)	13.1% (26/ 199)
Cardiovascular	% n/Pts	14.6% (29/ 198)	15.1% (30/ 199)
Previous Major Surgeries	% n/Pts	35.8% (69/ 193)	45.4% (88/ 194)
Treatment Currently treated	% n/Pts	73.7% (146/ 198)	
No current treatment	% n/Pts	26.3% (52/ 198)	
No previous treatment	% n/Pts	30.8% (61/ 198)	
At least 1 previous treatment	% n/Pts	69.2% (137/ 198)	
N. previous treatment	Median (IQR)	1.0 (1- 2)	
Type of current treatment			
Chlorambucil + Obinutuzumab	% n/Pts	2.0% (4/ 198)	
BR (Bendamustine + Rituximab)	% n/Pts	2.0% (4/ 198)	
FCR (Fludarabine + Cyclophosphamide + Rituximab)	% n/Pts	2.0% (4/ 198)	
FC (Fludarabine + Cyclophosphamide)	% n/Pts	0.5% (1/198)	
Ibrutinib	% n/Pts	32.8% (65/ 198)	
Idelalisib + Rituximab	% n/Pts	3.0% (6/ 198)	
Venetoclax + Rituximab	% n/Pts	8.1% (16/ 198)	
Venetoclax	% n/Pts	11.6% (23/ 198)	
Other	% n/Pts	11.6% (23/ 198)	

The EQ-5D-5L questionnaire showed no significant differences between groups: more than 80% of pts reported low values (1 or 2, indicating no or small impact) on all items. Median VAS was 75 for the TREATED and 80 for the W&W group (0-100; higher scores indicate higher QoL). QLQ C-30 / CLL-16 scores had very similar results between groups suggesting a limited impact of CLL on QoL. The median (IQR) QoL Scale was 83.3 (67- 83) for TREATED and 83.3 (67- 92) for W&W pts (0-100; for functional scales high scores represent a better level of functioning; for symptoms' scales low values indicate a less important symptomatology/problem). The main symptoms reported were fatigue, insomnia, pain, and dyspnea; the main worry was for "future health" (Figure 1). A statistical difference was found between the groups only for the QLQ-C30 Role Functioning Scale (p=0.024) and the Social Functioning Scale (p=0.003) and for the QLQ CLL-16 Infection Scale (p<0.001), all with slightly but significantly better results for the W&W pts.

**Conclusions:** CHOICE study helps to understand the COVID-19 pandemic impact on CLL pts feeling. Main limitation of the study was its cross-sectional design, not allowing to evaluate any change in QoL. CLL pts showed a good QoL, as confirmed by both EQ-5D-5L and EORTC QLQ C-30 / CLL-16 scores, with very similar results between TREATED and W&W pts (with slightly better results in the W&W pts). The CHOICE study results are consistent with previous reports; fatigue was the most reported symptom, the most relevant worry was for future health. Hospital accesses reduction due to COVID-19, and the extreme attention for the danger of infections might have influenced pts response, impacting their perception on future health.

**P39**

**INDUCTION OF NEUTRALIZING ANTIBODIES IN CLL PATIENTS AFTER SARS-COV-2 MRNA VACCINATION**

F. Mavilia<sup>1</sup>, F. Pratesi<sup>2</sup>, C. Barate<sup>3</sup>, E. Benedetti<sup>4</sup>, V. Guerri<sup>5</sup>, P. Sannurri<sup>5</sup>, P. Migliorini<sup>6</sup>, S. Galimberti<sup>7</sup>

<sup>1,3,4,5,6,7</sup>Dipartimento di Medicina Clinica e Sperimentale, U.O. Ematologia Universitaria, Università di Pisa; <sup>2,6</sup>Dipartimento di Medicina Clinica e Sperimentale, U.O. Immunologia Clinica, Università di Pisa, Italy

**Background:** SARS-CoV-2 infection increases the clinical risk and mortality of patients with chronic lymphocytic leukemia (CLL). Covid-19 vaccinations have the potential to protect individuals from severe infection, but little is known about the antibody response profile in these patients after the vaccination. We compared anti-RBD and neutralizing antibody responses, and also fluorescence activated cell sorting (FACS) analysis of peripheral blood mononuclear cells (PBMC) subpopulations in 27 patients with CLL to healthy donors after mRNA Covid-19 vaccination.

**Methods:** Of 27 patients enrolled in the study, 21 patients received BNT162b2 mRNA vaccine and 6 patients received Spikevax mRNA vaccine. The median age was 70.6 years, with 18 males and 9 females. 4 patients were in clinical remission after treatment, 10 patients were treatment-naïve and 13 patients were under treatment at the time of vaccination. Blood samples were taken before the vaccination and from 11 to 41 days after the second dose, with a median time of 23 days. The levels of anti-RBD IgG, IgM, IgA were evaluated by ELISA on recombinant RBD, the neutralizing antibody response was evaluated by SPIA assay. We also performed a FACS study of PBMC subpopulations, a burden disease assessment using blood indicators (LDH, beta-2-microglobulin, lymphocytic count) and imaging, as well as an evaluation of IgG levels at the time of vaccination.

**Results:** A comparison of anti-RBD antibody seroconversion (IgG, IgM, and IgA) between 29 patients with CLL and healthy control subjects indicated that CLL patients had a considerably lower response rate (50 percent vs 100 percent) and had lower antibody levels than healthy controls. The SPIA assay for neutralizing antibodies present after vaccination yielded the same result (50 percent vs 100 percent). No differences in peripheral blood mononuclear cells subpopulation were observed between pre and post-vaccination, with a tendency to significance for an increase of CD4+ TEMRA and a decrease of CD8+ TEMRA.

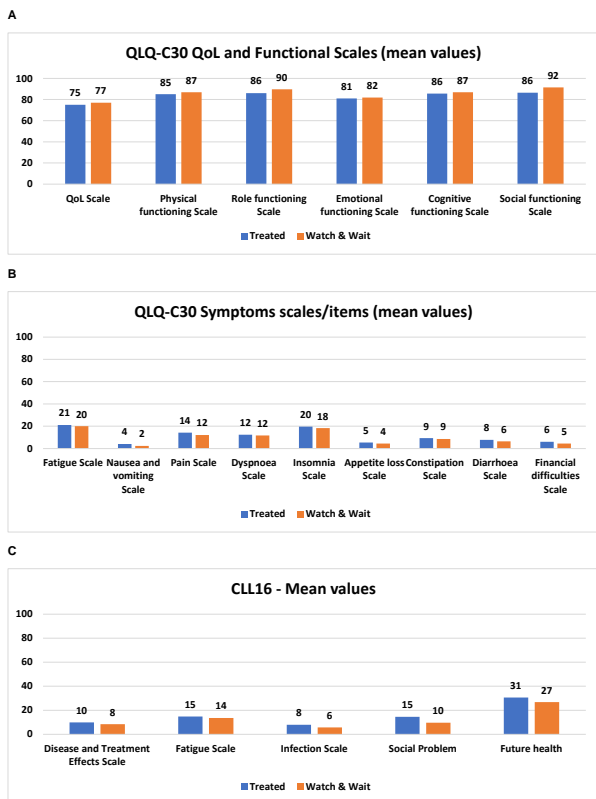

**Figure 1. EORTC QLQ C30 (A and B) and CLL-16 (C) results.**



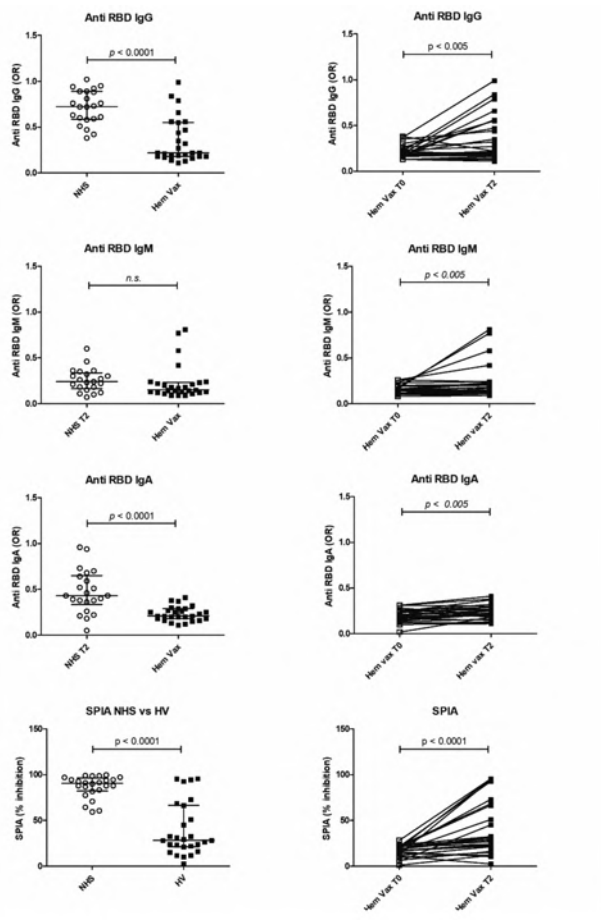

Figure 1. Anti-RBD antibodies.

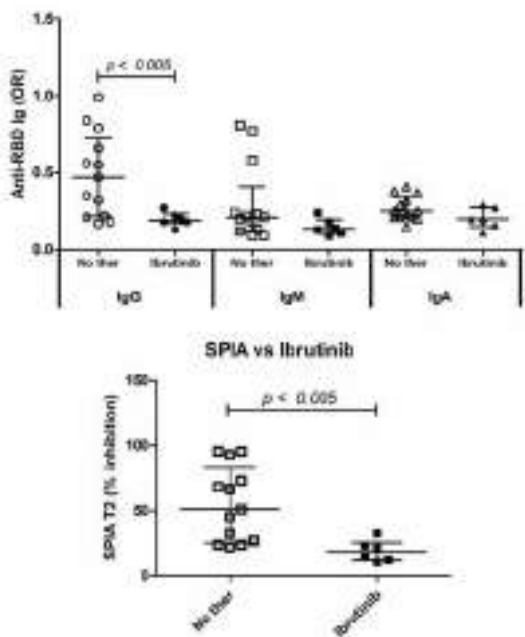

Figure 2. Anti RBD Ab and Ibrutinib.

There was no correlation between Ig or SPIA values and PBMC subsets, total IgG levels and serum LDH. We found an inverse correlation with spleen dimension ( $p < 0.05$ ) and with lymphonodal area ( $p < 0.005$ ). Stratifying patients according to presence of neutralizing antibodies after

the vaccination we found a larger prevalence of SPIA positives compared to SPIA negatives in treatment-naïve patients (60% vs 40%). Patients in clinical remission after therapy had a comparable result (75% versus 25%), however patients on treatment had a much lower percentage of SPIA positives (23.1% vs 76,9%).

**Conclusion:** Only around half of vaccinated CLL patients acquire detectable anti-RBD and neutralizing antibodies, according to our findings. Furthermore, we discovered a substantial difference in rates of detectable anti-SARS-CoV-2 antibodies between patients who were treatment-naïve/in clinical remission (9/14, 64.3%) and those who were on CLL-directed treatment (3/13, 23.1%).

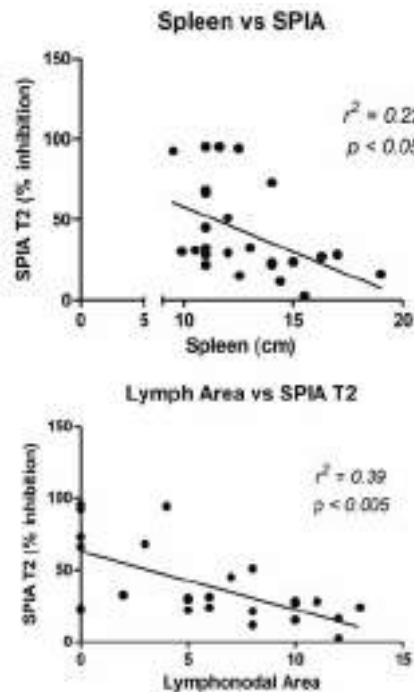

Figure 3. Spleen/Lymphonod vs SPIA.

**P40**

**THE DEDALO PROTOCOL: AN INTEGRATED APPROACH TO MRD IN CLL PATIENTS RECEIVING VENETOCLAX PLUS RITUXIMAB**

F. Mavilia, F. Ghio, G. Cervetti, C. Baratè, D. Dardanis, E. Mazzantini, P. Rossi, P. Sammuri, V. Guerri, C. Bono, S. Grassi, E. Benedetti, S. Galimberti

*Dipartimento di Medicina Clinica e Sperimentale, U.O. Ematologia Universitaria, Università di Pisa, Italy*

**Background:** In previous analyses, the MURANO study demonstrated significant progression-free survival (PFS) and overall survival (OS) benefit for fixed-duration venetoclax-rituximab treatment compared with bendamustine-rituximab in relapsed/refractory chronic lymphocytic leukemia (CLL) patients. Furthermore, the study demonstrated that deep responses with undetectable minimal residual disease (uMRD) were associated with favorable PFS. We designed the “Dedalo” study with the goal of testing MRD from a multidisciplinary point of view (flow cytometry, molecular biology and ultrasound) and of assessing MRD predictive/prognostic value.

**Methods:** up today 12 patients have been enrolled in the protocol; all were characterized by IgHV mutational status and TP53/del(17p) presence. MRD status was assessed by flow cytometry in peripheral blood from 7 patients after the first cycle (M1) and in 9 patients after the sixth cycle (M6) of Rituximab-Venetoclax, with a sensitivity of  $10^{-4}$ .

**Results:** Out of the 12 enrolled patients, until now no one had to discontinue the treatment and 3 patients reached the twelfth month of ther-

apy. After the first cycle, MRD status was assessed in 7 patients, with a 57% rate of PB undetectable MRD (less than  $10^{-4}$ ) and a 43% rate of low MRD positivity (defined as  $10^{-4}$  to  $< 10^{-2}$ ) and with 0% of high MRD positivity (defined as  $\geq 10^{-2}$ ). After the sixth cycle, conversely, MRD status was assessed in 9 patients, with a 78% rate of uMRD. Among the 3 patients carrying del(17p) or TP53 mutation, 1 patient reached uMRD after the first cycle, 1 patient has achieved a low MRD positivity after the first cycle, and 1 patient remained MRD positive after the sixth cycle.

**Conclusion:** With all patients still on treatment, a favorable MRD kinetics was observed in the venetoclax-rituximab setting. The majority of patients achieved PB uMRD after the first cycle of the treatment, with a higher percentage after the sixth cycle. These results are superimposable to those from Murano trial (at 4 months, uMRD 60%, low MRD positivity 20%, 78% at 6 months). The durability of uMRD rates, their role in the prediction of PFS in a real-life experience, and the effect of genetic characteristics on the MRD kinetics are still under investigation.

#### P41

##### MYD88 AND CXCR4 MUTATION ANALYSIS IN CHRONIC LYMPHOCYTIC LEUKAEMIA

C. Mereu<sup>1</sup>, M. Monne<sup>1</sup>, A. Uras<sup>1</sup>, G. Piras<sup>1</sup>, R. Asproni<sup>1</sup>, P. Malune<sup>1</sup>, A. Manai<sup>1</sup>, A. Bianchi<sup>1</sup>, A. Di Francesco<sup>1</sup>, A.D. Palmas<sup>1</sup>

<sup>1</sup>UOC Ematologia ASSL Nuoro-ATS Sardegna, Italy

**Introduction:** Mutations in *MYD88* and *CXCR4* genes appear to be significant in prognostic stratification of Waldenstrom Macroglobulinemia (WM) patients. In chronic lymphocytic leukaemia (CLL), it has been shown that *MYD88* L265P mutations, although rare (2-5%), may have prognostic implications, while functional coding mutations in *CXCR4* may be a rare cause of the disease, possibly accounting for approximately 1.6% of familial disease. While an essential role of *CXCR4* receptor in WM as well as in CLL has been established, *CXCR4* gene mutations in CLL are not well characterized. Aim of this study was to analyse *MYD88* and *CXCR4* gene mutations in patients with CLL and to evaluate the association with further genetic aberrations.

**Methods:** Thirty-one genomic DNAs from CLL patients (median age:74; males:20; females:11) were selected among samples referring to the laboratory of Haematology Unit of Nuoro Hospital for diagnostic purposes. Mutation analysis of *MYD88* region encompassing exons 4 and 5 was performed by Next Generation Sequencing (NGS) and Sanger sequencing, while *CXCR4* 3' coding region starting from amino acid 256 was analysed by bidirectional Sanger sequencing. Results of Dohner's CLL FISH panel was available for all cases, together with IGHV, *TP53* and *NOTCH1* mutational status. Mutated and unmutated IGHV status was equally distributed, deletion 13q FISH abnormality was present in 75% of cases, *TP53* mutation analysis was negative in all patients and *NOTCH1* c.7544\_7545delCT was observed in 7% of cases.

**Results:** The canonical *MYD88* p.L265P mutation (NM\_002468.4: c.794T>C) was detected in 2 cases (6,45%) and the *MYD88* p.R264Q and p.S243N in two more patients by NGS analysis. Variant allele frequencies were 41%, 10%, 48% and 36%, respectively. As expected, Sanger sequencing confirmed mutations with allele frequencies higher than 15%. Mutations of the *CXCR4* 3' coding region were not detected in any of the 31 analysed cases. All *MYD88* mutations co-occurred with FISH abnormality del13q, mutated IGHV, wt*TP53* and wt*NOTCH1* status.

**Conclusions:** We found a *MYD88* mutation rate of 12,9%, higher than frequencies previously reported in CLL and associated to favourable genetic alterations. Differently from WM, where the *MYD88* L265P is highly prevalent, we found that 2 out of 4 *MYD88* mutated CLLs harbour a non L265P variant. No *CXCR4* mutation was detected in our series, even though their presence cannot be excluded at sub-clonal level, in agreement with recent studies, where a very low prevalence (0-0,6%) of *CXCR4* mutations was found in CLL patients. Although *MYD88* mutations are present both in WM and CLL, a different mutational spectrum is observed in CLL patients. The absence of *CXCR4* mutations in CLL indicates that different genetic events are present in association in WM and CLL.

## Lymphomas

#### P42

##### PROTEIN KINASE CK2 INHIBITION IN MANTLE CELL LYMPHOMA SYNERGICALLY POTENTIATES VENETOCLAX INDUCED CYTOTOXICITY

S. Manni<sup>1,2</sup>, Z. Spinello<sup>1,2</sup>, M. Pesavento<sup>1,2</sup>, A. Fregnani<sup>1,2</sup>, L. Saggin<sup>1,2</sup>, L. Quotti Tubi<sup>1,2</sup>, G. Semenzato<sup>1,2</sup>, L. Trentin<sup>1,2</sup>, F. Piazza<sup>1,2</sup>

<sup>1</sup>Department of Medicine, Hematology and Clinical Immunology Branch, University of Padova; <sup>2</sup>Veneto Institute of Molecular Medicine (Padova), Italy

**Introduction:** Mantle cell lymphoma (MCL) is a tumor of B-cell origin characterized by frequent relapses. Recently, clinical effective drugs such as kinase inhibitors disrupting B-cell receptor signalling (Ibrutinib, Acalabrutinib) and antiapoptotic BCL2-family members blockers BH3-mimetics (such as Venetoclax) have emerged as effective options in the therapeutic armamentarium. However, resistance may occur, even in the setting of Venetoclax and Ibrutinib combination, prompting the quick search of new valuable targets. CK2 is a Ser/Thr kinase overexpressed in several blood tumors. By its "horizontal" action, CK2 supports oncogenic pathways activation, promotes tumor cell survival, and counteracts extrinsic and intrinsic apoptosis. A critical role for CK2 in the regulation of BCL2 family members has been suggested. In this work, we tested the impact of CK2 inhibition on Venetoclax (Ven)-induced cytotoxicity in MCL.

**Methods:** CK2 chemical inhibition was obtained with CX-4945 (Silmatasertib) in MCL cell lines (Rec-1, Granta-519 and Jeko-1) and in patient samples. CK2 silencing in MCL cell lines was achieved by the generation of cell clones stably transduced with IPTG-inducible lentiviral vectors coding for CK2-directed shRNAs. Survival, apoptosis, mitochondrial membrane depolarization and proliferation were investigated by FACS analysis of AnnexinV/PI and JC-10 staining. Apoptotic related proteins and phosphorylation of kinases downstream the BCR were analyzed by western blot (WB). The synergic action of the drugs was analyzed by the Chou-Talalay combination index method.

**Results:** The combination of CX-4945 with Ven increased MCL cell apoptosis, as judged by the augmented frequency of Annexin V positive cells and expression of cleaved PARP protein with respect to the single treatments. Intriguingly, the Venetoclax-induced increase of MCL-1 anti-apoptotic protein was lowered by the addition of CX-4945. CK2 silencing reproduced the results obtained with CX-4945 boosting the cytotoxic effect induced by Venetoclax. Analysis of cell cycle distribution confirmed an increased frequency of likely apoptotic cells in the sub G1 phase in CK2-silenced cells and a modulation of the other phases of the cell cycle. The addition of Ven caused a dose dependent rise of cells in sub G1 and a strong reduction of cells in S and G2/M phases. Remarkably, calculation of the Combination Index suggested a strong cell-killing synergic effect between CX-4945 and Ven on each cell line tested, including those less sensitive or resistant to Ven.

**Conclusions:** We demonstrated that the simultaneous inhibition of CK2 with Silmitasertib and BCL2 with Venetoclax synergistically cooperates in inducing apoptosis of MCL B-lymphocytes. These results suggest that the double targeting of CK2 and BCL2 may counteract mechanisms of resistance to apoptosis exploited by MCL tumor cells.

#### P43

##### CD79B EXPRESSION IN DIFFUSE LARGE B CELL LYMPHOMA AS ASSESSED BY FLOW CYTOMETRY OF LYMPH NODE BIOPSIES

S. Bellesi<sup>1</sup>, E. Maiolo<sup>1</sup>, F. Fatone<sup>1</sup>, E. Alma<sup>1</sup>, C. Iacovelli<sup>1</sup>, P.L. Puggioni<sup>1</sup>, F. Marchionni<sup>1</sup>, S. D'Innocenzo<sup>1</sup>, E. Meacci<sup>2</sup>, A. Contegiacomo<sup>1</sup>, F. Attili<sup>2</sup>, L.M. Larocca<sup>3</sup>, F. D'Alo<sup>1</sup>, S. Hohaus<sup>1</sup>

<sup>1</sup>Dipartimento di Diagnostica per Immagini, Radioterapia Oncologica ed Ematologia Fondazione Policlinico Universitario A. Gemelli, IRCCS Roma; <sup>2</sup>Dipartimento di Scienze Mediche e Chirurgiche, Fon-

dazione Policlinico Universitario A. Gemelli, IRCCS Roma; <sup>3</sup>Divisione di Anatomia Patologia e Istologia, Fondazione Policlinico Universitario A. Gemelli, IRCCS Roma, Italy

**Introduction:** The CD79b molecule is part of the B cell receptor (BCR) complex, composed of the antigen recognition part, surface immunoglobulin, and the signal transduction part, the CD79a/CD79b heterodimer. The anti-CD79b antibody-drug conjugate polatuzumab, is emerging as an effective therapeutic option for the treatment of diffuse Large B cell lymphoma (DLBCL). Data on expression of CD79b in DLBCL are very limited. The aim of our study was to assess expression of CD79b in lymph node biopsies from patients (pts) with DLBCL using flow cytometry (FC).

**Methods:** We analysed lymph node samples from 72 pts with DLBCL. Bioptic material was obtained between December 2015 and September 2021, either at the time of diagnosis in 66 pts or at relapse in 6 pts. Median age 61 range 22-88; 40 females and 32 males). Cell suspensions were prepared by mechanical disaggregation of solid tissues. Cells were incubated with 8 surface markers including the main diagnostic antigens of B-cell lymphomas (KappaV450/CD45V500/CD20FITC/CD79bPE/CD5PerCpCy5.5/CD19PECy7/CD10APC/LambdaAPCH7). Data were acquired with BDFACSCantoII (BD) and DXFlex (Beckman Coulter) cytometers. Pathological B cells were identified by a combination of physical parameters (FSC/SSC) and clonality markers (light chain restriction or absence of light chain expression on mature B cells). For each antigen we measured Median Fluorescence Intensity (MFI) on pathological CD19+ B cells and CD5+ T cells (negative control population) and we calculated the relative fluorescence intensity as MFI ratio (RMFI) between these two populations respectively.

**Results:** Median percentage of CD79b expression on DLBCL lymphoma B cells of 72 pts was 80% (IQR 26-95). CD79b was strongly positive (expressed on > 70% of cells) in 54.5% of pts (39/72), partially positive (expressed on 20-70% of cells) in 21% of pts (15/72), weakly positive (expressed on 1-20% of cells) in 5.5% (4/72) and negative (less than 1% positive cells) in 19% of pts (14/72). CD79b expression was observed in residual normal B cells in pts without CD79b expression on pathological B cells. No difference in CD79b expression was observed between samples at diagnosis and relapse. We observed a strong positive correlation between RMFI of CD79b and light chain expression (Pearson R=0.75, p < 0.0001). CD79b expression was not correlated with expression of CD20, CD10, and CD5 as assessed in FC. CD79a expression was assessed by IHC and positive in 28/29 (96.5%) samples, while CD79b expression in FC was present in only 19/29 pts (66%).

**Conclusions:** Our results indicate that expression of CD79b may be more heterogeneous in DLBCL as previously assumed, with 19% of DLBCL that do not express CD79b. This is in contrast to the nearly universal expression of CD79a in DLBCL. We conclude that flow cytometric studies on cell suspensions from biopsies are helpful to assess surface expression of target molecules in a quantitative method.

## P44

### HELLS SUSTAINS LYMPHOMA PROGRESSION BY PROMOTING TRANSCRIPTION AND BY RESOLVING DNA TOPOLOGICAL CONFLICTS

V. Fragliasso<sup>1</sup>, A. Tamani<sup>1</sup>, E. Sauta<sup>2</sup>, F. Torricelli<sup>1</sup>, V. Mularoni<sup>1</sup>, E. Vitale<sup>1</sup>, V. Manicardi<sup>1</sup>, M. Tigano<sup>3</sup>, A. Ciarrocchi<sup>1</sup>

<sup>1</sup>Laboratory of Translational Research, Azienda USL-IRCCS di Reggio Emilia; <sup>2</sup>IRCCS-Humanitas Research Hospital; <sup>3</sup>Sidney Kimmel Medical College, Thomas Jefferson University

**Introduction:** Transcription can be a risky process that imposes DNA-topological tensions. Nascent RNA pairs with its DNA-template and forms hybrid called R-loops. Accumulation and persistence of R-loops alter local chromatin structure, increase the density of RNA-PolymeraseII (RNAPII) and DNA-lesions. This phenomenon leads to chromosome rearrangements and genomic instability. Being deputed to DNA structures resolution, helicases sense DNA tension and operate to ease evolution of DNA-based processes. We recently identified the DNA-helicase HELLS as a new vulnerability of T-cell Lymphomas (TCLs). HELLS orchestrates a transcriptional program essential to the survival and pro-

liferation of TCLs and its genetic ablation impairs mitosis and cell proliferation.

**Methods:** RNA-seq and ChIP-seq were performed in TCL cells depleted for HELLS (HELLS<sup>KD</sup>). R-loops and γH2AX were detected by immunofluorescence (IF) using S9.6 and γH2AX antibodies respectively.

**Results:** To understand how HELLS manages and coordinates transcription and to define the HELLS-associated gene expression program in TCLs, we performed RNA-seq in HELLS<sup>KD</sup> cells. Gene expression profiling showed that HELLS depletion affects the expression of 728 genes (56% were downregulated) mainly involved in the regulation of cytoskeleton, chromatin remodelling and DNA repair as indicated by gene ontology analysis. Next, we performed ChIP-seq against histone markers (H3K4me3 and H3K9me3) and RNAPII. HELLS depletion results in no dramatic changes in the H3K4me3 and H3K9me3 levels at examined promoters. Although we did not also observe changes in RNAPII level, we detected significant changes in RNAPII distribution profile at transcriptional starting sites of a set of HELLS-target genes suggesting that HELLS alters RNAPII progression rather than its recruitment. Indeed, loss of HELLS leads to an accumulation of R-loops that co-localize with the active form of RNAPII, further suggesting that HELLS alleviates RNAPII stall upon collision with R-loops during elongation. We next confirmed that HELLS interacts with RNAPII and that the decreased RNAPII activity after HELLS depletion was associated with a significant decrease in the incorporation of 5-ethynyl uridine into nascent RNA confirming that transcription process is attenuated across all transcriptome. As R-loops accumulation is associated with DNA damage, we assessed by IF, the level of γH2AX upon HELLS<sup>KD</sup>. We observed a significant increase in the intensity of nuclear γH2AX signal and in the formation of γH2AX foci in HELLS<sup>KD</sup> cells. Noticeably, γH2AX foci accumulation was observed in correspondence of R-loops and in co-localization with RNAPII.

**Conclusions:** Our results indicate that HELLS supports TCL progression promoting gene expression by resolving R-loops, easing RNAPII progression and protecting DNA from damages simultaneously. These key functions qualify HELLS as a new dependency of TCLs and therefore as potential vulnerability of these lymphomas

## P45

### BONE MARROW MICROENVIRONMENT: A NOVEL THREE-DIMENSIONAL IN VITRO MODEL FOR THE STUDY OF REFRACTORY DLBCL

J. Ceccato<sup>1</sup>, M. Piazza<sup>1</sup>, I. Caputo<sup>1</sup>, F. Cinetto<sup>2</sup>, M. Pizzi<sup>1</sup>, S. Manni<sup>1</sup>, F. Piazza<sup>1</sup>, L. Trentin<sup>1</sup>, F. Vianello<sup>1</sup>

<sup>1</sup>Department of Medicine, University of Padova; <sup>2</sup>Ca' Foncello Hospital

**Introduction:** Diffuse large B cell lymphoma (DLBCL), the most common non-Hodgkin lymphoma, is characterized by rapid growing tumour masses in nodal or extranodal sites. Although immunochemotherapy is highly effective, yet about 30% of patients will relapse or exhibit refractory disease (r/r DLBCL). Bone marrow (BM) involvement is detectable in about 15% of DLBCL patients and it is associated with a worse prognosis, likely due to the interaction of DLBCL cells with the microenvironment. We sought to investigate the role of extracellular matrix (ECM) and mesenchymal stromal cells (MSCs) in the proliferation and response to therapy of DLBCL cells in a three-dimensional (3D) *in-vitro* microenvironment, aiming to establish a tool for testing patients-specific therapies.

**Methods:** Human femoral bone fragments were decellularized and then resettled to generate a 3D scaffold repopulated with MSCs line (HS-5) or human BM-derived MSCs. The spatial configuration of the model was studied by histological analysis, confocal microscopy and two photon techniques which allow us to digitally reproduce the 3D structure of the model. The pattern of growth of the OCI-LY18 DLBCL cell line was then analyzed in the decellularized scaffold and in the model in presence of MSCs. The induction of apoptosis following Ibrutinib exposure of DLBCL cells growing in the 3D model was then measured by Annexin V assay. 2D co-cultures were also evaluated and compared.

**Results:** We found that decellularized human bone scaffolds were effectively repopulated by the MSCs cell line as well as by human-derived MSCs. By exploiting an in-house device directing a flow of MSCs through the scaffold we were able to significantly improve recellularization. MSCs settled in the scaffold generated a 3D net extending in the trabecular spaces. We found that DLBCL cells were able to migrate, autonomously adhere and grow into the scaffold, either in presence and absence of MSCs. Interaction with the extracellular matrix likely plays a role in the strong adherence of DLBCL cells to the scaffold, with MSCs offering an additional niche. The interaction of DLBCL cells with the extracellular matrix and with MSCs significantly impaired cancer cell apoptosis induced by the Bruton's tyrosine kinase inhibitor, Ibrutinib. The magnitude of the protective effect of MSCs on DLBCL cells was higher in the 3D model.

**Conclusions:** Our results suggest that the DLBCL cells interact with the extracellular matrix and with MSCs in a 3D *in-vitro* model of human bone marrow. The biology of cell growth and response of tumor cells to spontaneous and drug-induced apoptosis differ from a conventional 2D model, suggesting that our 3D model may better reproduce how DLBCL cells interact with the bone marrow microenvironment. Our 3D model may be exploited to develop patient-specific platforms for drug screening and personalized therapy in r/r DLBCL.

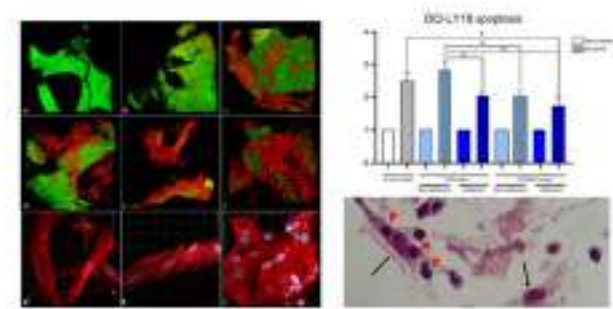

Figure 1.

#### P46

##### PRECLINICAL EFFICACY AND BIOLOGIC EFFECTS OF VENETOCLAX-IXAZOMIB COMBINATION IN LYMPHOMA CELL LINES

M. Cosenza, S. Sacchi, S. Pozzi

Dipartimento di Scienze Mediche e Chirurgiche Materno-Infantili e dell'Adulto, Università di Modena e Reggio Emilia, Italy

**Introduction:** Venetoclax is Bcl-2-targeting drug showing preclinical and clinical activity in hematologic malignancies. Due to the development of resistance and the loss of dependence on the target protein, the monotherapy may be insufficient for maximal effectiveness. To circumvent the resistance mechanisms, many preclinical studies have shown that combination of venetoclax with other agents may represent a more effective therapeutic strategy. Ubiquitin-proteasome signaling pathway is a potential target that plays an important role in the proteolysis of key regulatory proteins. Proteasome inhibitors include ixazomib that inhibits cell growth and induces apoptosis in hematological malignancies cells resistant to conventional therapies and to bortezomib.

**Methods:** We performed preclinical screening of 12 lymphoma cell lines that included 3 DLBCL, 2 FL, 2 MCL, 1 CTCL, 1 ALCL, 2 HL, 1 CLL and two MCL primary patient samples, treated with different concentrations of venetoclax and ixazomib alone and in combination. Cell viability was determined by MTS. Cell cycle and apoptosis were evaluated by flow cytometry. ERK1/2 and AKT signaling pathways were evaluated by western blot analysis.

**Results:** Venetoclax with ixazomib produced a synergistic effect in the most lymphoma cell lines and in two MCL primary patient samples leading to inhibition of cell growth and induction of apoptosis accompanied by increased cleavage of caspases-3, -9 and PARP. We observed an additive effect in Jeko1 (MCL) and MEC1 cells (CLL) and antagonist effect in Hut78 cells (CTCL). Our results suggest that com-

bination treatment inhibits lymphoma cell proliferation by affecting cell cycle arrest at G0/G1 phase through inhibition of cyclin D1 and upregulation of p27 and p21. The combination can lead to cell death by inducing apoptosis and autophagy mediated by expression of ER stress proteins, of the pro-apoptotic proteins as Bax, Bad, and Noxa that control pathways to autophagy or apoptosis. Enhanced cell death is associated with ERK 1/2 inactivation and with a reduction of AKT.

**Conclusion:** We have shown that the venetoclax-ixazomib combination has a synergistic effect in several lymphoma cell lines. Thus, these data offer a rationale to deeply exploring the biological effects of the combination.

#### P47

##### DISSECTING THE ADAPTIVE RESPONSE TO ARGININE DEPRIVATION IN HODGKIN LYMPHOMA

A. Romano<sup>1</sup>, F. Puglisi<sup>1</sup>, A. Padella<sup>2</sup>, N.L. Parrinello<sup>1</sup>, G. Scandura<sup>1</sup>, D. Cambria<sup>1</sup>, E. La Spina<sup>1</sup>, A. Barbato<sup>3</sup>, C. Giallongo<sup>4</sup>, D. Tibullo<sup>5</sup>, G.A. Palumbo<sup>4</sup>, C. Cerchione<sup>2</sup>, G. Martinelli<sup>2</sup>, G. Simonetti<sup>2</sup>, F. Di Raimondo<sup>1</sup>

<sup>1</sup>Department of General Surgery and Medical-Surgical Specialties, A.O.U. "Policlinico-Vittorio Emanuele"; <sup>2</sup>Istituto Scientifico Romagnolo per lo Studio e Cura dei Tumori (IRST) IRCCS; <sup>3</sup>Department of Clinical and Experimental Medicine; <sup>4</sup>Department of Medical and Surgical Sciences and Advanced Technologies "G.F. Ingrassia"; <sup>5</sup>Section of Biochemistry, Department of Biomedical and Biotechnological Sciences

In Hodgkin Lymphoma (HL), arginine (Arg) degrading enzyme Arginase-1 is increased. However, how Arg starvation in the HL microenvironment can contribute to neoplastic cell fitness is largely unknown. To this end, four human cHL cell lines (L428, L540, HDMYZ and KM-H2) were individually cultured with customized complete media or lacking or Arg (R0), supplemented with 10% dialyzed fetal bovine serum, in six independent experiments. After 48 hours of culture, the cells were collected for global metabolomic analysis, by gas chromatography-mass spectrometry (GC/MS) and liquid chromatography-tandem mass spectrometry (LC/MS/MS) platforms by Metabolon Inc and transcriptome profiling by RNA-seq. The effect on the cellular metabolome depended largely on the cell type examined with L428 and KMH2 cells having significantly changed metabolomes. Pyruvate was significantly higher in the KMH2 cells deprived of Arg compared to controls. Consistent with a metabolic rewiring to maintain mitochondrial integrity (the pyruvate is an important intermediary in the conversion of carbohydrates into fatty acids), the adaptive response was associated to increased oxidative stress, as suggested by reduced glutathione in KMH2 cells, depletion of gamma-glutamylcysteine, increased cystine, the oxidative product of cysteine, and methionine sulfoxide (an oxidation product of methionine). Gene set enrichment analysis (GSEA) showed deep transcriptome rearrangements in KMH2 and HDMYZ cell lines, involving upregulation of genes required for the unfolded protein response (UPR, including XBP1, EIF2S1, EIF4A2, EIF4A3, ATF3, ATF4, DDIT4, EDEM1, GADD45B, SQSTM1, HMOX), NF- $\kappa$ B response to TNF (including RAF1, TNF, LIF, NKBIA, SGK1, BIRC3, ICAM1, BCL6, IL6, RELA, CDKN1A), p53 pathway and networks (including CDKN2B, STOM, TRAF4, RRAD, SESN1, FOXO3, SERPINB5, JAG2) and proteasome degradation (HSPA4, PSMD11, PSMD13, PSMD2, PSMA5, PSMA7, PSMC4), with a minimal effect on metabolism features, except the upregulation of genes involved in lactate generation and degradation. All lines tested showed down-regulation of CCN12, LCROL, MKI67, NCAPG, PEX10 and UFSP2, suggesting that early response to arginine deprivation includes modulation of UFMylation pathway, the most recently discovered post-translational protein modification system, whose biological function is largely unknown. Thus, the cell-cycle arrest in G2, the increase of pyruvate availability and the upregulation of proteasome function via upregulation of the UFMylation pathway suggest the dependency of HL cell lines on mitochondrial function integrity. Quantity and function of mitochondria network can play a major role in selecting the fittest clones, a metabolic pathway that should be explored as novel non-synthetic lethal targets.

## P48

### IMPACT OF COVID-19 PANDEMIC ON CHEMO-IMMUNOTHERAPY IN LYMPHOMA PATIENTS : A SINGLE CENTRE RETROSPECTIVE ANALYSIS OF 320 HODGKIN/ NON-HODGKIN LYMPHOMA PATIENTS

G. Urbano, A. Fiorentini, M. Petrini, G. Gini, A. Olivieri

*Clinica di Ematologia - Ospedali Riuniti, Italy*

**Introduction:** There are few reports about the management of chemo-immunotherapy during COVID-19 pandemic in lymphoma patients. The aim of this study was to assess whether COVID-19 pandemic caused a significant prolongation of time of treatment plan completion in lymphoma patients treated at our Centre.

**Methods:** We retrospectively collected data from 320 HL/ NHL consecutive patients treated at our Centre from July 2018 to October 2021 with pre-COVID-19 pandemic period being considered from July 2018 to February 2020 and COVID-19 period from March 2020 to October 2021 (20 months each). We evaluated the delay (days) in completion of the therapeutic plan for each patient. Chemo-immunotherapeutic regimens were divided into 5 groups: regimens requiring hospitalization, ABVD-like, CHOP-like, platinum/bendamustine-based and immunotherapy maintenance/monotherapy regimens. Mann-U-Whitney test was used to evaluate statistical differences in delay of treatment plan completion of each regimen-group between pre-COVID-19 and COVID-19 period.

**Results:** In pre-COVID-19/COVID-19 periods, median time of delay of therapeutic program, regarding therapies requiring hospitalization, CHOP-like, ABVD-like, platinum/bendamustine-based and immunotherapy maintenance/monotherapy regimens were 15 days (range 6-103)/32 days (range 0-154) , 4 days (range 0-57)/0 days (range 0-61), 3 days (range 0-38)/1 day (range 0-19), 2 days (range 0-44)/6 days (range 0-57) and 0 days (range 0-26)/3 days (range 0-210), respectively. No differences in delay of treatment program were found in regards of therapies requiring hospitalization ( $p=0.4$ ), ABVD-like ( $p=0.55$ ) and platinum/bendamustine-based regimens ( $p=0.2$ ), comparing pre-COVID-19 and COVID-19 periods. A difference in completion anticancer program for patients treated with CHOP-like regimens was found, with a significant delay in the pre-COVID-19 era ( $p<0.01$ ). Prophylactic use of PEG-G-CSF during CHOP-like regimens was found to be more frequent in the COVID-19 era ( $p<0.01$ ). Moreover, there was a significant extension in planned therapy duration for immunotherapy maintenance/monotherapy regimens ( $p=0.01$ , Figure 1), in the COVID-19 period.

**Conclusions:** Our results demonstrate the practice of cancer care prioritization in lymphoma patients in our Centre, maintaining dose density in high grade lymphomas, mainly due to aggressive prevention infection strategies and expanded use of PEG G-CSF. The delay in completion of anti-CD20 regimens during COVID-19 era is likely due to the questionable efficacy of anti-SARS-CoV-2 vaccination in patients undergoing anti-CD20 maintenance, that led to its temporary discontinuation in most cases. A prospective assessment of the impact of the delay of immunotherapy maintenance on progression-free survival is undergoing.

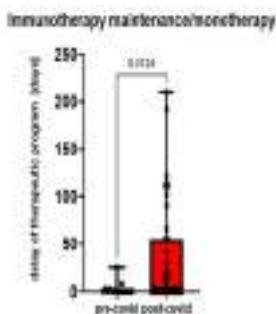

Figure 1.

## P49

### HIGHLY REARRANGED HYPER-TETRAPLOID (98-100 CHROMOSOMES) SPORADIC BURKITT LYMPHOMA WITH SOLELY BONE MARROW/LEUKEMIC PHASE PRESENTATION: A CASE REPORT AND LITERATURE REVIEW

C. Giordano<sup>1</sup>, G. Cerciello<sup>1</sup>, I. Pisano<sup>2</sup>, N. Pugliese<sup>1</sup>, A. Vincenzi<sup>1</sup>, A. D'Ambrosio<sup>1</sup>, M. Capone<sup>2</sup>, B. Izzo<sup>2,3</sup>, M. Pace<sup>4</sup>, M. Mascolo<sup>4</sup>, M. Picardi<sup>1</sup>, F. Pane<sup>1</sup>

<sup>1</sup>Department of Clinical Medicine and Surgery, Hematology Unit, Federico II University Medical School, Naples; <sup>2</sup>CEINGE Biotecnologie Avanzate, Federico II University Medical School, Naples, Italy; <sup>3</sup>Dipartimento di Medicina Molecolare e Biotecnologie Mediche (DMMBM), Federico II, University Medical School, Naples; <sup>4</sup>Department of Advanced Biomedical Sciences, Pathology Unit, Federico II University, Medical School, Naples, Italy

Burkitt leukemia is characterized with bone marrow- and blood-predominant or exclusive disease, and is considered a variant of Burkitt lymphoma in the 2016 WHO classification. A 76-year-old man was admitted to our Hematology outpatient Department of Federico II University of Naples because of persistent asthenia in the last 7 days. Hematologic findings upon admission were: hemoglobin 75 g/L, platelets  $47 \times 10^9/L$  and white blood cell count  $1.5 \times 10^9/L$  with absolute neutrophil count of 290/mm<sup>3</sup> and absolute lymphocytes count of 750/mm<sup>3</sup>. There was no lymphadenopathy or organomegaly at physical exam and patient clinical history revealed no previous pathologies and a normal blood cell count one month earlier. Lactate dehydrogenase was 2319 IU/L ; viral screening (EBV, HCV, HBV and HIV, HTCLV) resulted negative. The bone marrow exam resulted in punctio sicca, but peripheral blood smear showed a 55% of atypical large immature cells (CD19+, CD20+, CD23, CD10+, CD5+, CD38+, and CD43+ cells with kappa light chain restriction). Karyotype analysis on peripheral blood showed highly rearranged hypertetraploid karyotype with a modal number of 98-100 chromosomes, including three X and three Y chromosomes, characterized by structural as well as numerical abnormalities. The bone marrow biopsy, at a low power view, showed a diffuse proliferation of small and medium-sized, monotonous neoplastic lymphocytes (CD20+, CD79a+, Pax5+, CD10+, Bcl6+, CD43+, c-Myc+ and Ki67 of 100%), with the characteristic "starry-sky" pattern due to interspersed macrophages engulfed with tingible bodies.

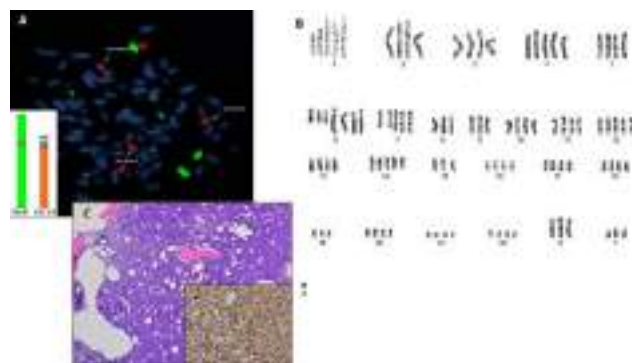

Figure 1. A: FISH findings of two copies of reciprocal translocation  $t(8;14)(q24;q32)$  and an extra copy of  $der(14)t(8;14)(q24;q32)$ , defined by FISH using Whole chromosome 8 and 14 painting probes and c-Myc break-apart probe; Three copies of a derivative chromosome that result from a translocation of p arm of chromosome 6 and q arm of chromosome 8, defined by FISH using Whole chromosome 6 and 8 painting probes and c-Myc break-apart probe; two copies of isochromosome 7p; a marker chromosome derived from chromosome 7, defined by FISH using Whole chromosome 7 painting probe (not shown here). B: Patient karyotype and cytogenetic analysis: 98-100,XXYY, + X, + Y,  $der(?;1)(?;q10)x2$ ,  $der(?;6)(?;p10)x3$ ,  $i(7)(p10)x2$ ,  $t(8;14)(q24;q32)x2$ , -9,+12, +13,+ $der(14) t(8;14)(q24;q32)$ , +mar[cp10]. C: bone marrow biopsy showing a diffuse infiltrate of uniform irregular lymphocytes, with the characteristic starry-sky pattern (haematoxylin and eosin, neoplastic lymphocytes stain for protein c-Myc (anti-protein c-Myc, original magnification x10).

A total body fluoro-deossi-glucose (FDG)-positron emission tomography (PET) was performed and multiple uptakes solely from bones were recorded. A diagnosis of highly rearranged sporadic Burkitt lymphoma stage IV (bone marrow and blood exclusive disease) was made. Patient began antibiotic prophylaxis with fluorochinolones and fluconazoles and anti-haemorrhagic prophylaxis. The clinical conditions rapidly worsened with rapid requirement of platelets and blood transfusion. According to age and patient's performance status, chemotherapy treatment with R-CHOP-21 schedule was employed and he received neutropenia prophylaxis with growth stem cell factor daily administration and anti-haemorrhagic prophylaxis but died 3 days after the first course of chemotherapy treatment for acute haemorrhage cerebral infarction. In literature, a karyotype study on recurrent alterations associated with MYC rearrangements in 37 cases of Burkitt lymphoma showed several associations such as that of 1q gain, structural 13q alterations or chromosome 6 derivatives. These findings suggest that distinct molecular pathways may be involved in the progression of the different categories of MYC-rearranged lymphomas with complex genomic alterations. Similar alterations were described in a study of paediatric Burkitt lymphoma cases, whose data support the frequent occurrence of 1q and 13q abnormalities with bone marrow involvement. Several genes in the 1q region encode proteins involved in prevention of apoptosis, such as BCL9 and MCL1, that may be involved in Burkitt lymphoma pathogenesis while chromosome 13 candidate genes include BAFF (13q32q34) which is shown to be involved in tumor cells apoptosis. Our findings suggest that distinct molecular pathways may be involved in the progression of the different categories of MYC-rearranged lymphomas with complex genomic alterations.

## Monoclonal Gammopathies and Multiple Myeloma

### P50

#### A COMPREHENSIVE INTRACELLULAR NAD<sup>+</sup> DEPLETION PRIMES MM CELLS TO DNA DAMAGING AGENTS BY TRIGGERING OXIDATIVE STRESS

D. Soncini<sup>1</sup>, E. Gelli<sup>1</sup>, F. Piacente<sup>2</sup>, P. Becherini<sup>3</sup>, C. Martinuzzi<sup>1</sup>, A. Nencioni<sup>4</sup>, S. Bruzzone<sup>2</sup>, A. Bellotti<sup>5</sup>, M. Duschosal<sup>5</sup>, A. Nahimana<sup>5</sup>, R.M. Lemoli<sup>1,3</sup>, M. Cea<sup>1,3</sup>

<sup>1</sup>Clinic of Hematology, Department of Internal Medicine (DiMI), University of Genoa; <sup>2</sup>Department of Experimental Medicine, Biochemistry unit, University of Genoa; <sup>3</sup>IRCCS Ospedale Policlinico San Martino, Clinic of Haematology; <sup>4</sup>IRCCS Ospedale Policlinico San Martino; <sup>5</sup>Central Hematology, Research Laboratory (LHER)

**Introduction:** Multiple myeloma (MM) is an incurable disease with still unexplored metabolic-pathways dependency. We previously reported that Nicotinamide Adenine Dinucleotide (NAD<sup>+</sup>), a master regulator of catabolic metabolism and several enzymatic activities, plays a crucial role for MM cells growth; as a result, small molecules targeting the rate-limiting NAD<sup>+</sup> producer enzyme NAMPT, have potent anti-MM activity. Despite this evidence, clinical benefits of NAMPT inhibitors are limited, suggesting that alternative NAD<sup>+</sup> production routes confer resistance. Here we investigated biological relevance of nicotinic acid phosphoribosyltransferase (NAPRT, which together with NADSYN, accounts for the Preiss-Handler pathway NAD<sup>+</sup> salvage pathway) in MM cells, investigating then the clinical relevance of a comprehensive NAD<sup>+</sup> depletion for anti-MM strategy.

**Methods:** Gene expression analysis of NAD<sup>+</sup> producing enzymes (NAMPT, NAPRT and NADSYN) and its correlation with clinical data (OS and PFS) was performed on MMRF CoMMpass study. Next, a GSEA algorithm on biological modules was run on tumors carrying low- vs high-NAD producers' signatures. Chemical and genetic lentiviral-based approaches were both used to test biological relevance of NAPRT in a panel of MM cell lines. Then, an anti-MM drugs screening was utilized to challenge fully-NAD depleted MM cells using different viability tools. Detailed mechanistic studies were also performed with qPCR, western blot and immunofluorescence analyses. Finally, clinical benefits of our findings were accomplished by challenging publicly available datasets on ASCT-treated MM patients.

**Results:** A comprehensive RNAseq analysis from CoMMpass dataset sharply divided MM patients on their NAD<sup>+</sup> producing enzymes expression. As a result, "high-NAD<sup>+</sup> producers" showed poorer prognosis than those expressing low mRNA levels, in term of PFS and OS as well. In line with these data, a panel of MM cell lines showed a pervasive expression of these enzymes regardless of specific genetic background. Importantly, an increased genomic instability characterized NAPRT-depleted cells later showing that a fully intracellular NAD<sup>+</sup> shortage primes MM cells to DNA damaging agents. The oxygen reactive species generation was accountable for observed synergism, also maintained in cells with lower NAPRT baseline levels. Finally, a focused ASCT-treated MM patient analysis, revealed worst outcome for "high-NAD<sup>+</sup> producers" thus suggesting a clinical relevance for our strategy.

**Conclusions:** Our data provide evidence that NAD<sup>+</sup> biosynthesis impairment affects MM cells viability and results in genomic instability. As result, a comprehensive NAD<sup>+</sup> depletion with dual NAPRT and NAMPT inhibition primes MM cells to alkylating agents, the backbone strategy for ASCT-eligible patients.

### P51

#### BLOCKING LACTATE TRAFFICKING IN MULTIPLE MYELOMA MICROENVIRONMENT MAY BE A POTENTIAL TARGET FOR ANTI-CANCER THERAPY

A. Barbato<sup>1</sup>, C. Giallongo<sup>2</sup>, E. La Spina<sup>4</sup>, G. Lazzarino<sup>3</sup>, A. Romano<sup>1</sup>, G. Lazzarino<sup>5</sup>, N.L. Parrinello<sup>4</sup>, G.A. Palumbo<sup>2</sup>, G. Li Volti<sup>3</sup>, D. Tibullo<sup>3</sup> F. Di Raimondo<sup>1</sup>

<sup>1</sup>Department of clinical and experimental medicine (MEDCLIN), Uni-

versity of Catania; <sup>2</sup>Department of Medical, Surgical sciences and advanced technologies, G.F. Ingrassia, University of Catania; <sup>3</sup>Department of biomedical and biotechnological sciences, University of Catania; <sup>4</sup>Azienda ospedaliero-universitaria Policlinico Vittorio Emanuele; <sup>5</sup>International university of health and medical sciences, Unicamillus

**Introduction:** Multiple myeloma (MM) is a B-cell malignancy characterized by an accumulation of clonal plasma cells (PCs) in the bone marrow. Tumour cells can shift between Warburg effect and OXPHOS, and PCs can upload lactate from the microenvironment through monocarboxylate transporter 1 (MCT1). The aim of this work was to evaluate whether lactate trafficking could favour immune escape and drug resistance. **Methods:** Treg and monocytic-myeloid derived suppressor cells (M-MDSCs) expansion, mitochondrial depolarization (MD) and apoptosis were measured by FACS. Gene expression was carried out by qRT-PCR. **Results:** Peripheral blood (PB) of MM patients showed high levels of circulating lactate. Following culture of healthy PB mononucleated cells in presence of MM sera, the percentage of both Treg and M-MDSCs resulted significantly increased. The addition of AZD3965 (AZD), a MCT1 inhibitor, reverted this effect. Moreover, MM PCs directly promote Treg expansion through lactate release and AZD inhibited this effect. Culturing MM cell lines in presence of lactate, we observed over-expression of genes involved in OXPHOS together with a significant increase in ROS production. We, therefore, evaluated BTZ efficacy in MM after prolonged lactate exposure. Of note, BTZ toxicity decreased, and a concomitant increase of mitochondrial mass was observed. We also treated MM cells with BTZ alone or in combination with AZD in presence of MM serum adding or not AZD. Apoptosis increased in MM cells pre-treated with AZD compared to cells treated with BTZ alone and BTZ-induced MD was not significantly affected after AZD pre-treatment. Lactate can also act as a signaling molecule through GPR81 receptor activation whose expression resulted significantly increased in MM cell lines after lactate exposure. We, therefore, tested whether lactate effects observed previously were metabolism- or GPR81-mediated. Interestingly, 3,5 DHBA, a GPR81 agonist, was not able to expand Treg and MDSC. In addition, we treated MM cells with BTZ in presence of MM serum adding or not 3-OBA, a GPR81 inhibitor. We found that both apoptosis and MD decreased in cells pre-treated with 3-OBA compared to cells treated with BTZ alone, suggesting that GPR81 inhibition prevents lactate to act as a ligand but not as a metabolite, entering the cells through MCT1 channel. **Conclusions:** In conclusion, blocking lactate trafficking in MM may be a potential target for anti-cancer therapy.

## P52

### LOW IGM IS ASSOCIATED TO INFERIOR SARS-COV-2 SPIKE ANTIBODY RESPONSES TO TWO DOSES OF COVID-19 RNA VACCINATION IN ELDERLY PATIENTS WITH MULTIPLE MYELOMA

A. Romano<sup>1,2</sup>, D. Leotta<sup>1</sup>, D. Cambria<sup>1</sup>, B. Garibaldi<sup>1</sup>, E. La Spina<sup>1</sup>, S. Filetti<sup>1</sup>, A. Bulla<sup>1</sup>, G.A. Palumbo<sup>1,3</sup>, V. Del Fabro<sup>1</sup>, C. Conticello<sup>1</sup>, F. Di Raimondo<sup>1,2</sup>

<sup>1</sup>U.O.C. Ematologia, Azienda Policlinico-Rodolico San Marco; <sup>2</sup>Dipartimento di Chirurgia generale e Specialità Medico Chirurgiche, Università di Catania; <sup>3</sup>Dipartimento Ingrassia, Università di Catania, Italy

Patients with multiple myeloma frequently present with substantial immune impairment and an increased risk for infections and infection-related mortality. During COVID-19 pandemics we aimed to evaluate the immune response in MM patients vaccinated for SARS-CoV-2 during their active anti-MM treatment. The study included 78 multiple myeloma patients undergoing treatment and a control group composed of 15 health care workers and 11 patients affected by low-risk smoldering Multiple Myeloma (sMM). All participants had received two doses of the BNT162b2 (Pfizer-BioNTech) vaccine. The serology testing was done using Quant II IgG anti-Spike severe acute respiratory syndrome coronavirus 2 (SARS-CoV-2) assay by Abbott 30 days after receipt of the second dose of the vaccine. All subjects in the control group developed a positive antibody response at 30 days after the second vaccine dose [defined as 50 arbitrary units per milliliter (AU/ml), or higher] as com-

pared with 41% (37 of 89) in the MM group (active MM + sMM). 34 MM patients had undetectable antibody levels defined as <10 AU/ml. The median anti-Spike IgG levels in the MM group requiring treatment (median, 12.3; range, 10.6-98.7) were significantly lower than those in the control group (median, 649.8; range, 149-1787,  $p < 0.0001$ ) and sMM (median, 591.7; range, 240.1-880.7,  $p < 0.0001$ ). Median IgG levels in MM patients carrying IgM <50 (N=54) was lower than those with IgM  $\geq 50$  (N=24,  $p = 0.003$ ), independently from treatment type. Patients on frontline therapy (N= 25) produced higher anti-spike antibody levels than previously treated patients on therapy (N=53,  $p = 0.02$ ). Only exposure to high-dose steroids was associated to reduced antibody levels, since the median IgG levels in MM patients requiring Dexamethasone 40 mg/week (N=47) were significantly lower than those in MM patients who did not receive steroids (N=31,  $p < 0.0001$ ). Per internal policy, all patients interrupted steroids seven days before and seven days after vaccine inoculation. Furthermore, MM patients with a very good complete response or more (VGPR, N=28) achieved higher antibody levels (median 281.9 AU/mL) than those who were not in CR (median 67.0 AU/mL;  $p < 0.0001$ ). The odds of being in the lower quartile IgG anti-Spike after two doses of the BNT162b2 were significantly higher for older individuals (odds ratio, 1.11 per 1 year of age; 95% CI, 1.08 to 1.20;  $p = 0.004$ ), for patients carrying IgM <50 mg/dL (odds ratio, 2.71; 95% CI, 1.13 to 7.51;  $p = 0.05$ ), in absence of a deep response defined as very good partial response remission or better (odds ratio, 2.71; 95% CI, 1.13 to 7.51;  $p = 0.05$ ). Taken together, our results indicate that more advanced disease and worse disease status are associated to an inferior response to COVID-19 mRNA Pfizer vaccination, without any significant difference due to the ongoing anti-MM treatment.

## P53

### ULTRASOUND EVALUATION OF THE ATRIAL CHAMBERS IN THE PATIENTS WITH LIGHT CHAIN AMYLOIDOSIS

V. Del Fabro<sup>1</sup>, C. Bellofiore<sup>1,2</sup>, L. Patanè<sup>3</sup>, S. Mangiafico<sup>3</sup>, A. Orofino<sup>1,2</sup>, A. Romano<sup>1,2</sup>, M. La Morella<sup>2</sup>, C. Tamburino<sup>3</sup>, F. Di Raimondo<sup>1,2</sup>, C. Conticello<sup>1</sup>

<sup>1</sup>U.O.C. Ematologia, Azienda Policlinico-Rodolico San Marco; <sup>2</sup>Dipartimento di Chirurgia generale e Specialità Medico Chirurgiche, Università di Catania; <sup>3</sup>U.O.C. Divisione di Cardiologia, Azienda Ospedaliera Universitaria Policlinico-Vittorio Emanuele, Italy

**Background:** Immunoglobulin light chain amyloidosis (AL) is due to a small B-cell clone producing monoclonal light chains (LC) that could deposit in different tissues leading to organ failure. The heart is the most important organ in terms of prognosis. Indices of cardiac involvement are serological (proBnp and Troponin) and instrumental (echocardiogram and cardiac MRI) but these investigations do not give us information about the atrial chambers.

**Aims:** To evaluate right and left atrial chambers and their function in patients affected by AL amyloidosis. **Methods:** 24 patients (pt) were studied. Serum pre- and post-therapy evaluation of ProBNP, Troponin, protein, albumin, Beta2microglobulin, Free Light Chain (FLC) involved, uninvolved chain and ratio, kidney and liver markers were performed in addition to ultrasound (US) evaluation [LAD (left atrial diameter), LAV 2DE (left atrial volume by 2-dimensional echocardiography), LAEF 2DE (left atrial ejection fraction by 2-DE), LAEF 3DE (left atrial ejection fraction by 3-dimensional echocardiography), RAA (right atrial area), IVSs (interventricular septum end systole), PWTd (posterior left ventricular wall thickness end diastole), PWTs (posterior left ventricular wall thickness end systole), RVDdb (right ventricular basal diameter), RV-Sm (peak systolic velocity of lateral tricuspid annulus), LV TEI index (Left ventricular myocardial performance index), LVGLS 2DE (left ventricular global longitudinal strain by 2-DE), LV ASP (left ventricular apical sparing pattern of longitudinal strain)]. We tried to correlate serological and instrumental parameters to find some significant correlation.

**Results:** Pt had received 1, 2 (9, 37.5%), rarely 3 or 4 lines of therapy (LOT, 5, 21%; 3, 12.5%). Median age was 52 years (range 37-79), half of pt were male (54%). Median time from diagnosis was 3 years (range 1-12). Multiple myeloma was present in 15 (62.5%) pt. Heart

involvement was present in 14 (58%) pt, kidney involvement in 23 (96%) pt and liver involvement in 5 (21%) pt. Among pt with heart involvement, the majority was under stage II, 3 pt were at stage IIIB. 15 pt are in course of treatment (62.5%), 7 in follow up (29%), 2 pt died during first LOT (8%) (Table 1). Median OS was not reached while PFS from the first line of therapy was 68 months (range 32.8- 103.15). None of US parameters had an impact on PFS. Among evaluated parameters we have found a significant correlation ( $p < 0.05$ ) among pre-ProBNP value and right atrial volume and among Troponin value and several right atrial parameters and with thickened ventricular walls in systolic phase.

**Conclusions:** These preliminary data demonstrate a significant correlation between parameters known to define the amyloidogenic cardiac involvement of AL and parameters concerning the atrial chambers, especially right, on a limited group of AL pt. These are preliminary data that should be extended to a greater number of pt in order to understand whether atrial involvement can have a prognostic impact in the disease.

Table 1.

Patients characteristics	total number 24
Median age	52 (37-79)
Male	13 (54%)
Histotype	15 I/9 k
Median time from diagnosis	3 (1- 32)
Multiple myeloma	15 (62,5%)
Heart involvement	14 (58%)
Kidney involvement	23 (96%)
Liver involvement	5 (21%)
Stage	
Line of therapy-1	24 (100%)
Line of therapy-2	4 (17,5%)
Line of therapy-3	5 (21%)
Line of therapy-4	3 (12,5%)
On treatment	15 (62,5%)
Followup	7 (29%)
Death	2 (8%)
Ejection fraction at diagnosis	>45% (45-70)

patients (39%) achieved a very good partial response (VGPR), 16 (45%) achieved PR, 2 (5%) a minimal response (MR) and 1 (3%) had a stable disease (SD). ORR at best response was 97% (56% CR, 30% VGPR, 4% PR), 1 patient (3%) had SD. At last follow up ORR was 53%: (36% CR, 8% VGPR, 8% PR), one (3%) had a SD. Progression disease (PD) occurred in 16 patients (44%), 15 of them were exposed to another treatment, among them 9 patients were exposed to at least two more treatments including novel agents (Daratumumab, Pomalidomide, Belantamab-Mafodotin). Median PFS was not reached and so was median OS calculated from the beginning of KRd. 9 patients (25%) reported grade 3-4 hematological AEs, 13 patients experienced (36%) grade 3-4 non-hematological AEs, only 3 (8%) cardiovascular AEs. Lenalidomide was reduced in 21 (58%), interrupted in 9 (25%) patients due to serious adverse events (SAEs). During Sars-Cov-2 pandemic waves, to reduce hospital admission, 8 patients who achieved at least VGPR continue halved Carfilzomib administration schedule (total dose 27 mg/m2 once every 2 weeks instead of twice) maintaining previous response except for 1 patient who experienced PD (at cycle 32, after one more year of KRd treatment). Real-world experiences often significantly diverge from randomized clinical trials for patients selection resulting into differences in terms of efficacy and tolerability. In our study KRd combination deepened response over time without relevant toxicity as showed also in a subgroup analysis of ASPIRE and ENDEAVOR. In addition, schedule modification during Sars-Cov-2 pandemic reduced the number of hospital admissions without losing quality of response, thus opening the question of which is the best administration regimen of Carfilzomib as maintenance.

Table 1.

Patients characteristics	
Median age	65.5 (42-80)
>70 years	15 (41.6%)
Median time from diagnosis	7 years ( 2-21 years)
Median LOT	1
First relapse	24 (66.6%)
Second relapse	8 (22%)
Third relapse	3 (8%)
Cytogenetics (22/39)	0.5% high risk; 55% standard risk
Aggressive disease (4/ IMD-1APL)	14%
Renal failure (eGFR<30ml/min)	8 (3%)
Previous ASCT	18 (50%)

**P54**

**CONTINUOUS THERAPY WITH CARFILZOMIB-LENALIDOMIDE-DEXAMETHASONE (KRd): A MULTICENTRIC EXPERIENCE IN REAL-LIFE**

V. Del Fabro<sup>1</sup>, B. Garibaldi<sup>1,2</sup>, A. Orofino<sup>1,2</sup>, A. Romano<sup>1,2</sup>, U. Markovic<sup>3</sup>, A. Condorelli<sup>1,2</sup>, R. Sciortino<sup>1,2</sup>, C. Cangialosi<sup>4</sup>, M. Gentile<sup>5</sup>, G. Uccello<sup>6</sup>, F. Di Raimondo<sup>1,2</sup>, C. Conticello<sup>1</sup>

<sup>1</sup>U.O.C. Ematologia, Azienda Policlinico-Rodolico San Marco; <sup>2</sup>Dipartimento di Chirurgia generale e Specialità Medico Chirurgiche, Università di Catania; <sup>3</sup>Unità di Oncoematologia e Trapianto di Midollo Osseo, Istituto Oncologico del Mediterraneo; <sup>4</sup>U.O.C. Ematologia A. O. Ospedali Riuniti Villa Sofia-Cervello; <sup>5</sup>Unità di Ematologia A.O. di Cosenza; <sup>6</sup>U.O.C. Ematologia, ARNAS Garibaldi, Italy

The irreversible proteasome inhibitor Carfilzomib has a proven efficacy in doublet and triplet combinations for the treatment of patients with relapsed or refractory multiple myeloma (RRMM) as shown in the ENDEAVOR and ASPIRE trials. Here we retrospectively analyzed a series of RRMM patients treated with KRd regimen over 18 cycles to evaluate efficacy and tolerability of continuous treatment (Table 1). Data were elaborated using SPSS Statistics Version 26. Overall survival (OS) was calculated from the time of the beginning of treatment until the date of death for any cause or last follow-up visit. Progression free survival (PFS) was defined as the time from the beginning of treatment to documented progression. OS and PFS were analysed by the Kaplan-Meier test. The statistical significance level was set at the 95th percentile. 36 patients were enrolled at one Calabrian and three Sicilian centres on behalf of the Sicilian Myeloma Network from June 2016 to November 2021. 24 of them were on first relapse (66,6%). Median number of cycles was 31.5 (range 18-61). Overall response rate (ORR) at first response to KRd was 92%: 3 patients (8%) achieved a complete response (CR), 14

**P55**

**CHEMO OR CHEMO-FREE REGIMENS IN HEAVILY PRETREATED MULTIPLE MYELOMA? ROLE OF BENDAMUSTINE-BORTEZOMIB-DEXAMETHASONE (BVD) IN NOVEL AGENTS' ERA**

C. Cerchione<sup>1</sup>, L. Catalanò<sup>2</sup>, D. Nappi<sup>3</sup>, S. Rocco<sup>4</sup>, S. Palmieri<sup>4</sup>, A.E. Pareto<sup>2</sup>, G. Musuraca<sup>1</sup>, S. Ronconi<sup>1</sup>, M. Ceccolini<sup>1</sup>, D. Cangini<sup>1</sup>, F. Pane<sup>2</sup>, F. Ferrara<sup>4</sup>, G. Martinelli<sup>1</sup>

<sup>1</sup>Hematology Unit, Istituto Scientifico Romagnolo per lo Studio e la Cura dei Tumori (IRST) IRCCS; <sup>2</sup>Hematology, AOU Federico II; <sup>3</sup>Department of Hematology & CBMT, Ospedale di Bolzano; <sup>4</sup>Hematology, A.O.R.N. Cardarelli, Italy

The treatment of heavily pretreated Multiple Myeloma continues to be considered as an important unmet clinical need. Bendamustine is an old bi-functional alkylating agent which has proved to be effective in relapsed, refractory and in new diagnosed Multiple Myeloma (MM). Thus, aiming to provide further insights in this field, also in novel agents' era, we present here a retrospective, real-life analysis of patients with relapsed/refractory MM (rrMM), who had received salvage therapy with bendamustine in combination with bortezomib and dexamethasone (BVD). 81 patients (44 M/37 F), with rrMM, median age at diagnosis 59.4 years (r. 36-82), median age at start of treatment 63.6 years (r.37-



86) treated with several lines of treatments (median 6, r. 2-11), every refractory to all the drugs previously received (also Bortezomib), received BVD (B 90 mg/sqm days 1,2; V 1.3 mg/sqm days 1,4,8,11, D 20 mg days 1,2,4,5,8,9,11,12, Pegfilgrastim day +4) every 28 days, until progression. All patients had previously received bortezomib-based and IMiDs-based treatments, and 32% (26/81) had also received radiotherapy. 69% (56/81) had undergone single or double autologous and three (2%) allogeneic stem cell transplant. All patients were relapsed and refractory to last therapies received before BVD. Bendamustine was well tolerated, with grade 3-4 transfusion-dependent anemia in 56% (46/81) of patients, and 43% (35/81) grade 3-4 neutropenia (no hospitalization was required, no septic shocks were observed). No severe extrahematologic toxicity was observed, only grade 1 gastrointestinal side effect (nausea), treated by common antiemetic drugs. According to IMWG, ORR was 63% (51/81: 7 CR, 18 VGPR, 15 PR, 11 MR) with 11 PD and 19 patients in SD, which can be considered as an impressive result in this subset of rMM patients. In particular, for 11 patients, BVD was, after having achieved at least a PR, a bridge to second auSCT, and for two patients a bridge to alloSCT. Eight patients have surprisingly achieved a notable PR after failure of novel agents (*i.e.* Carfilzomib, Daratumumab and Pomalidomide). Median time to response was 1.3 months (r.1-3), median OS from diagnosis was 67.3 months (r.6-151), median OS from start of Bendamustine was 9.6 months (r.2-36). The triplet Bendamustine-Bortezomib-Dexamethasone has shown significant efficacy in a particularly severe setting of patients, relapsed and refractory to all available therapeutic resources, and, in particular cases, it could be considered as a bridge to a second autologous or allogeneic SCT, also after failure of novel agents.

## P56

### LENALIDOMIDE/DEXAMETHASONE COMBINATION AS FIRST-LINE ORAL THERAPY OF FRAIL MULTIPLE MYELOMA PATIENTS: AN UNICENTRIC REAL LIFE STUDY

V. Del Fabro<sup>1</sup>, V. Leotta<sup>1</sup>, M.A. Di Giorgio<sup>1,3</sup>, C. Bellofiore<sup>1,3</sup>, U. Markovic<sup>4</sup>, A. Romano<sup>1,2</sup>, A. Orofino<sup>1,3</sup>, A. Bulla<sup>1</sup>, A. Curtopelle<sup>1,3</sup>, F. Elia<sup>1</sup>, F. Di Raimondo<sup>1,2</sup>, C. Conticello<sup>1</sup>

<sup>1</sup>Divisione di Ematologia, Azienda Policlinico-OVE, Università di Catania; <sup>2</sup>Dipartimento di Chirurgia generale e Specialità Medico Chirurgiche, Università di Catania; <sup>3</sup>Scuola di specializzazione in Ematologia, Università di Catania; <sup>4</sup>Unità di Oncoematologia e Trapianto di Midollo Osseo, Istituto Oncologico del Mediterraneo, Italy

Since few years, Lenalidomide plus dexamethasone (Rd), has become a new standard of care for newly diagnosed multiple myeloma (NDMM) patients not eligible for autologous transplantation. The phase 3 trial FIRST showed that continuous therapy with Rd is superior in PFS and OS to fixed therapy or triplets including melphalan, thalidomide and prednisone (MPT), leading to approval of Rd for NDMM. However, little is known about safety and efficacy of Rd in frail and ultra-frail patients. From June 2016 to September 2021, 89 consecutive frail NDMM patients were treated with Rd regimen, according to the FIRST schedule. Frailty was defined by International Myeloma Working Group (IMWG) frailty score and also with the simplified frailty scale by Facon et al. We evaluated safety and efficacy of Rd combination and the prognostic significance of several parameters on PFS and OS. 89 patients were treated with Rd schedule, median age was 77 years (range 41-92). 50 patients (56.2%) were >75 years old. 67 patients had an ECOG  $\geq 2$  (75%), 55 patients had an IMWG frailty score  $\geq 2$  (62%). According to the simplified frailty score, all 89 patients (100%) were considered frail. Creatinine clearance was lower than 30 ml/min in 12 patients (13%). Median duration of follow up was 26 months. 58 patients (65.2%) had one or more adverse events (AEs) of grade 3 or 4 (G3/4); among them, 24 (27%) experienced G3/4 hematological AEs, with anemia as the most frequent toxicity. 43 patients (48%) reported G3/4 non hematological toxicity. On the date of the last follow-up, 42 out of 89 patients (47.2%) were alive, 24 (26.9%) of these patients were still in treatment with Rd, 10 (11.2%) progressed and underwent a second line treatment. 32 patients died (23 were in disease progression), while 8 patients discontinued the

treatment due to toxicity or other complications. Median duration of oral treatment was 7 months (range 0.2-54.1), Median PFS was 14 months (range 5.2-22.7). Median PFS was not reached for fit patients; for unfit and frail patients was 14 (range 12.7-15.2) and 8 (range 6.1-9.8) months respectively. Among 76 evaluable patients who received at least 2 cycles, the Overall Response Rate was 68.4% (N=52), including 23 (30.3%) very good partial response (VGPR) and 25 (32.8%) partial response (PR), with 4 (5.2%) complete response (CR). Median OS was 21 months (range 11.3-30.6) Median OS was not reached for fit patients; for unfit and frail patients was 28 (range 2-56) and 8 (range 0.5-25.5) months respectively (Figure 1). These real-world data report the use of the Rd treatment in a population rarely included in randomized clinical trials. Older and more frail patients benefit from Rd combination also in the era of Monoclonal Antibodies. Treatment is manageable and G3/4 AEs are less than pivotal trial probably because a wide use of supportive care such as growth factors and vaccination. We therefore conclude that Rd could be used in patients with high ECOG or age >75 years.

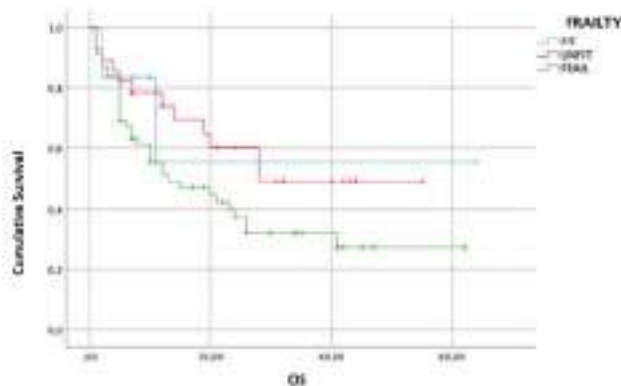

Figure 1. OS for fit, unfit and frail patients.

## P57

### ERECTILE DYSFUNCTION (ED) IN PATIENTS WITH LIGHT-CHAIN AMYLOIDOSIS (AL): DIAGNOSIS AND CORRELATION WITH THE HEMATOLOGIC DISEASE

C. Giordano<sup>1</sup>, G. Cerciello<sup>1</sup>, N. Pugliese<sup>1</sup>, D. De Novellis<sup>1</sup>, A. D'Ambrosio<sup>1</sup>, A. Salemme<sup>1</sup>, G. Delle Cave<sup>1</sup>, A. Vincenzi<sup>1</sup>, A. Fiumarella<sup>1</sup>, F. Garifalos<sup>2</sup>, R. Pivonello<sup>2</sup>, M. Picardi<sup>1</sup>, F. Pane<sup>1</sup>

<sup>1</sup>Department of Clinical Medicine and Surgery, Hematology Unit, Federico II University Medical School; <sup>2</sup>Department of Clinical Medicine and Surgery, Endocrinology Unit, Federico II University Medical School, Italy

ED can be an early AL feature.

**Aim:** investigate the incidence and evaluate the presence and possible causes of ED. **Methods:** All male patients with AL attending the Haematology Department of Federico II University were enrolled, from July to November 2021. Patients older than 70y and/or with ECOG  $\geq 2$  were excluded. Andrological assessment was performed by G.F and P.R and consisted in physical examination, power Doppler ultra-sound evaluation and a questionnaire concerning sexual activity (IIEF-15). Mayo clinic staging assessment was reported for all patients at diagnosis and enrolment.

**Results:** 13 patients were enrolled: 5 at AL diagnosis ("treatment naïve") while 8 in follow-up after AL treatment ("Off-therapy"). In the latter, hematologic CR and VGPR were recorded in 5/8 and 3/8 patients, respectively (median 48 and 67 mo); complete organ response was recorded in all. Hormonal dosages resulted within the reference limit for all patients and nobody suffered from pathological depression according to our psychologist consultant (S.A). ED prevalence was 92%: 9 severe, 1 moderate and 2 mild ED. The flowmetric indices showed a reduction of peak systolic value (PSV) in 77% of patients and a pathological acceleration (Acc) in 4/13. Patients with pathological Acc showed a higher age (p=0.05) and worse scores at IIEF-TOT (p=0.006), at Desire Func-

tion (p=0.01), at Overall Satisfaction (p=0.03); patients with severe ED showed a higher age (p=0.003) and a pathological left Acc value (p=0.04); patients with mild ED and normal erectile function (localized AL) showed normal right PSV (p=0.004) and normal left PSV (p=0.006) compared with patients with moderate and severe ED. For the two groups ED prevalence and ED stage was homogenous as the flowmetric characteristics. In the "off-therapy" group no differences were found according to hematologic response. Patients were offered, after cardiological consultation, a therapy with PDE5-I on demand with sildenafil 100 mg cp, to be taken about 60 minutes before intercourse, 4 patients (with moderate ED) accepted the therapy and presented for clinical consultation after 1 month showing clinical benefit and increase in parameters objectively assessed through the IIEF-15 standardized questionnaire.

**Conclusion:** A strong association between arterial inflow deficit, penile hemodynamic alteration, and ED was outlined. A possible cardiotoxic effect of extracellular light chain was disclosed by the presence of early endothelial dysfunction in systemic AL independently of treatment received, time from AL diagnosis and organ involvement. A possible indication our study may provide is that any patient seeking medical advice for unexplained ED should undergo AL screening.

**Table 1. Patients clinical and haematological characteristics.**

	Treatment naive group (n=5)	Off-therapy group (n=8)	p value
Age, median (range)	53 (41-62)	61 (55-69)	0,49
Time from diagnosis, median (range)	5 days (2-8)	66 months (10-112)	
<b>Characteristics at AL diagnosis</b>			
Localized AL	1 (0,2)	0	
Lambda isotype	2 (0,4)	6 (0,75)	0,28
Monoclonal component g/l, median (range)	3 (4,1-12,3)	4 (3,5-7,2)	0,63
Dfc mg/l, median (range)	223,4 (2,7-560)	77,9 (0,32-248)	0,17
Cardiac involvement	4 (0,7)	5 (0,6)	0,21
Revised Mayo clinic stage III	1 (0,2)	2 (0,25)	
Revised Mayo clinic stage IV	3 (0,6)	3 (0,37)	0,47
Troponin (median,ng/l)	96 (10-100)	90 (20-420)	0,93
NT-ProBNP (median,ng/l)	6037 (80-9588)	4829 (80-29133)	0,92
Renal involvement	3 (0,6)	7 (0,87)	0,07
Proteinuria g/24h, median (range)	1474 (140-14250)	5169 (30-7193)	0,01
Neurological involvement	0	1 (0,12)	
Liver involvement	1 (0,2)	0	
Gastrointestinal involvement	0	1 (0,12)	
Number of organs involved			
1 organ	3 (0,6)	2 (0,25)	
2 organs	0	5 (0,6)	
3 organs	2 (0,4)	1 (0,12)	0,04

Values are n (%) unless otherwise notified.

**P58**

**ADDITION OF CARFILZOMIB AS A THIRD AGENT IN LENALIDOMIDE-REFRACTORY MULTIPLE MYELOMA: SWITCHING FROM DOUBLET TO TRIPLET**

C. Cerchione<sup>1</sup>, L. Catalano<sup>2</sup>, D. Nappi<sup>3</sup>, S. Ronconi<sup>1</sup>, M. Ceccolini<sup>1</sup>, D. Cangini<sup>1</sup>, G. Musuraca<sup>1</sup>, F. Pane<sup>2</sup>, G. Martinelli<sup>1</sup>

<sup>1</sup>Hematology Unit, Istituto Scientifico Romagnolo per lo Studio e la Cura dei Tumori (IRST) IRCCS, Meldola; <sup>2</sup>Hematology, AOU Federico II; <sup>3</sup>Department of Hematology & CBMT, Ospedale di Bolzano, Italy

Carfilzomib is an epoxyketone proteasome inhibitor of second generation, proved to be effective and safe in relapsed and refractory Multiple Myeloma (rrMM), in combination with dexamethasone or lenalidomide and dexamethasone. In this retrospective observational trial, it has been evaluated efficacy and safety of carfilzomib, in combination with lenalidomide-dexamethasone (KRD) as salvage regimen in patients with rrMM, refractory to lenalidomide, where lenalidomide-based regimens have no proven efficacy. 41 patients (23 M/18 F), with rrMM, median age at diagnosis 63.7 years (r. 43-82), median age at start of treatment 67 years (r. 48-84) previously treated with several lines of treatments (median 3, r. 2-11), underwent to KRD regimen (ASPIRE trial schedule) for a median treatment cycles of 8 (r 2-18). ISS was equally distributed, and all patients had previously been treated with bortezomib and IMiDs, and were refractory to this agents. 61% (19/31) of them had undergone at least to a single ASCT. According to IMWG criteria, after a median follow-up of 9 months (r. 2-18), ORR was 68,2% (28/41: 9 CR, 12 VGPR, 7 PR) with 5 progressive diseases (PD) and 8 patients in stable disease (SD): this can be considered as an impressive result in this subset of rrMM patients, refractory to lenalidomide. In particular, for 11 patients, KRD was, after having achieved at least a PR, a bridge to sec-

ond/third autologous SCT. Median time to response was 1.3 months (r.1-4), median OS from diagnosis was 62 months (r. 9-170), median OS from start of Carfilzomib was 11 months (r. 2-18). Carfilzomib was well tolerated, with grade 2 anemia in 39%(16/41) of patients, successfully managed by ESAs, without necessity of blood transfusions; 29% (12/41) grade 3-4 neutropenia (pegfilgrastim in primary prophylaxis was given, no ospedalizzazione was required, no septic shocks were observed); 34% (14/41) grade 2, 21% (9/41) grade 3 and 12% (5/41) grade 4 thrombocytopenia, without hemorrhagic events and transfusion-dependency. Moreover, it was observed pneumonia in 39% (16/41) of patients, treated by common antibiotic drugs and always solved. A cardiac monitoring was performed for all patients: hypertension (grade 2-3) in 34% (14/41) of patients; fatigue in 39% (16/31) of patients. Carfilzomib-Lenalidomide-Dexamethasone has shown significant efficacy in a particularly severe setting of patients, relapsed and refractory to all available therapeutic resources, also lenalidomide, and it could be considered as a bridge to a second autologous or allogenic SCT.

**P59**

**DOMESTIC OPPORTUNITY IN HEAVILY PRETREATED MULTIPLE MYELOMA NOT ELIGIBLE TO HOSPITAL-BASED TREATMENT: ROLE OF POMALIDOMIDE-DEXAMETHASONE**

C. Cerchione<sup>1</sup>, L. Catalano<sup>2</sup>, D. Nappi<sup>3</sup>, A.E. Pareto<sup>2</sup>, G. Musuraca<sup>1</sup>, A. Lucchesi<sup>1</sup>, S. Ronconi<sup>1</sup>, M. Ceccolini<sup>1</sup>, D. Cangini<sup>1</sup>, F. Pane<sup>2</sup>, G. Martinelli<sup>1</sup>

<sup>1</sup>Hematology Unit, Istituto Scientifico Romagnolo per lo Studio e la Cura dei Tumori (IRST) IRCCS; <sup>2</sup>Hematology, AOU Federico II; <sup>3</sup>Department of Hematology & CBMT, Ospedale di Bolzano, Italy

Many patients affected by heavily pre-treated Multiple Myeloma could be not eligible to hospital-based treatment: in this context domestic opportunities should be considered. Pomalidomide is a new generation IMiD, with a very good compliance, thanks to oral administration, which can be used also in heavily pretreated patients, in a domestic setting. In this retrospective observational trial. It has been evaluated efficacy and tolerance of pomalidomide plus dexamethasone (PD) as salvage regimen in heavily pretreated patients with relapsed and refractory MM (rrMM), whose prognosis is particularly severe. 57 patients (31 M/26 F), with rrMM, median age at diagnosis 69 years (r. 52-86), and median age at start of treatment 76 years (r.56-90) treated with several lines of treatments (median 7, r. 2-11), every refractory to all the drugs previously received (also Bortezomib, Thalidomide and Lenalidomide), received Pomalidomide-Dexamethasone (Pomalidomide 4 mg for 21 days, Dexamethasone 40 mg days 1,8,15,22, pegfilgrastim day +8) every 28 days, until progression. ISS was equally distributed, and cytogenetic at relapse was evaluable in 14 patients. All the patients had previously been treated with schedule containing bortezomib and IMiDs. 63% (36/57) had undergone at least to a single ASCT. All patients were relapsed and refractory to last therapies received before PD. Pomalidomide was well tolerated, with grade 3-4 transfusion-dependent anemia in 58% (33/57) of patients, 44% (23/57) grade 3-4 neutropenia (pegfilgrastim in primary prophylaxis was given, no hospitalization was required, no septic shocks were observed), 40% (23/57) grade 3-4 thrombocytopenia without hemorrhagic events and transfusion-dependence. No severe extra-hematologic toxicity was observed. According to IMWG, ORR1 (≥PR) was 47.3% (27/57: 5 CR, 11 VGPR, 7 PR, 4 MR), but, considering that we are evaluating a cohort of heavily pretreated patients, with poor prognosis, another parameter should be considered, ORR2 (≥SD), considering stable disease as a successful result in progressive MM. ORR2 was 77.1% (17 SD). These can be considered as impressive result in this subset of patients. Oral treatment gives a really good compliance, in frail and unfit patients, and response, when present, is always really fast (median time to response: 2 months (r.1-6)), median OS from diagnosis was 94 months (range 21-234), median OS from start of pomalidomide was 9 months (range 1-25). Nine patients have surprisingly achieved a notable response (3 VGPR, 4 PR, 2 MR) after failure of novel agents (i.e. Carfilzomib, Daratumumab and Pomalidomide). Pomalidomide-dexamethasone has shown significant efficacy and a very good compliance, thanks to oral administration, in a particularly severe setting of

heavily pretreated patients, relapsed and refractory to all available therapeutic resources, also after failure of novel agents.

**P60**

**SERUM FREE LIGHT CHAIN RATIO AS A BIOMARKER OF MULTIPLE MYELOMA PROGRESSION AND ASSOCIATED RENAL DISEASE**

D. De Novellis<sup>1</sup>, A. Carobene<sup>1</sup>, R. Fontana<sup>1</sup>, B. Serio<sup>1</sup>, I. Ferrara<sup>1</sup>, M. Martorelli<sup>1</sup>, R. Guariglia<sup>1</sup>, S. Luponio<sup>1</sup>, I. Ruggiero<sup>1</sup>, V. Giudice<sup>1,2</sup>, C. Selleri<sup>1,3</sup>

<sup>1</sup>Hematology and Transplant Unit, University Hospital “San Giovanni di Dio e Ruggi d’Aragona”; <sup>2</sup>Clinical Pharmacology Unit, University Hospital “San Giovanni di Dio e Ruggi d’Aragona”; <sup>3</sup>Department of Medicine, Surgery and Dentistry “Scuola Medica Salernitana”, Italy

**Introduction:** Serum free light chain (FLC) ratio is a specific and sensitive method to detect light chain hyperproduction and is a biomarker of multiple Myeloma (MM) progression from premalignant conditions. We evaluated the prognostic role of FLC ratio at diagnosis in predicting progression-free (PFS) and overall survival (OS) and investigated possible correlations between FLC ratio and clinical characteristics.

**Methods:** A total of 33 fit MM patients who received induction therapy and autologous stem cells transplantation at the Hematology and Transplant Center, University Hospital “San Giovanni di Dio e Ruggi d’Aragona” of Salerno from 2015 to October 2021 was included in this retrospective study (Table 1). Quantification of FLC ratio at diagnosis was performed by nephelometric assays, and standardized (sFLC) as follows: involved/uninvolved chain. Correlations between sFLC ratio and clinical parameters were investigated by univariate and multiple linear regression models, while PFS and OS were analyzed by Mantel-Cox proportional hazard regression model. A P < 0.05 was considered statistically significant.

Table 1. Patients’ characteristics at baseline.

Characteristics	N = 33
Median age, years (range)	62 (46-73)
Gender, n (%)	
Male	18 (53)
Female	15 (47)
Chromosome 17 deletion, n (%)	
Yes	4 (12)
Not available	5 (15)
M-protein type, n (%)	
IgG	20 (60)
IgA	7 (21)
IgD	1 (3)
Microglobulin	4 (12)
Not secreted	1 (3)
Light chain type, n (%)	
Kappa	17 (52)
Lambda	16 (48)
Median flow cytometry plasma cell, % (range)	6 (0-25.4)
Median serum M-protein, g/dl (range)	2.7 (0-5.9)
Median sFLC ratio (range)	15.4 (1-3640)
Median β-2 microglobulin, ng/dl (range)	3.3 (1.4-19)
Median albumin, g/l (range)	3.3 (2.4-9)
Median LDH, mU/ml (range)	95 (17-900)
Median glomerular filtration rate, ml/min (range)	61 (4-120)
Myeloma International Staging System, n (%)	
I	13 (40)
II	12 (36)
III	8 (24)
Extramedullary disease, n (%)	7 (21)
First line treatment, n (%)	
Bortezomib-Thalidomide-Dexamethasone	15 (45)
Bortezomib-Lenalidomide-Dexamethasone	15 (45)
Others	3 (10)
Lenalidomide maintenance after autologous transplant, n (%)	19 (58)
Median PFS, months (range)	26 (2-95)
Median OS, months (range)	43 (6-104)

**Results:** Effects of gender (male, P = 0.28), age (P = 0.75), MM type (micromolecular, P < 0.005), M-protein level (P = 0.05), free light chain type (lambda, P = 0.34), β-2 microglobulin (P < 0.005), LDH (P = 0.66), albumin (P = 0.9), flow cytometry plasma cell count (P = 0.62), and extramedullary disease (yes, P = 0.76) on sFLC ratio were investigated by univariate linear regression analysis. By multiple linear regression, only micromolecular MM (P = 0.05) and β-2 microglobulin (P < 0.005)

were significantly associated to sFLC ratio. Moreover, sFLC ratio inversely correlated with glomerular filtration rate at diagnosis (r = -0.45; P = 0.009) by Pearson analysis. No influences on PFS [median PFS 26 months; HR:0.93 (CI: 0.85-1.03); p=0.21] and OS [median OS 43 months; HR:0.97 (CI:0.92-1.02); p= 0.27] by sFLC ratio were observed in our cohort.

**Conclusions:** Diagnostic and predictive roles of serum sFLC ratio in MM has been largely evaluated in recent years. In our study, sFLC ratio was significantly associated with micromolecular MM and β-2 microglobulin likely because of a delay in MM diagnosis ultimately leading to higher disease burden, especially in the absence of heavy chain M-protein at serum electrophoresis. Moreover, the inverse correlation between sFLC ratio and glomerular filtration rate might be related to an early damage of FLC excess on renal tissue.

In conclusions, our preliminary results confirmed the importance of early FLC evaluation for diagnosis of micromolecular and lower disease burden MM, reducing the risk of renal damage. However, further validation on larger and prospective clinical studies are needed

**P61**

**AGE AND SEX IN MGUS, AN ELECTROPHORETIC STUDY OF SERUM PROTEINS**

R. Salierno<sup>1</sup>, L. Guarnera<sup>4</sup>, F. Bonanni<sup>4</sup>, D. Anastasi<sup>2</sup>, S. Casciani<sup>1</sup>, M.T. Calio<sup>1</sup>, A. Viola<sup>1</sup>, S. Bernardini<sup>1,2</sup>, L. Franceschini<sup>3</sup>, R. Secchi<sup>4</sup>, F. Frenza<sup>4</sup>, F. Meconi<sup>4</sup>, L. Gianni<sup>3</sup>, M. Rizzo<sup>3</sup>, M. Cantonetti<sup>3,4</sup>, M. Morello<sup>1,2</sup>

<sup>1</sup>Proteinology Section, Clinical Biochemistry and Clinical Pathology Department of Laboratory Medicine University of Rome Tor Vergata, Tor Vergata University Hospital (PTV); <sup>2</sup>Clinical Biochemistry and Molecular Biology Department of Experimental Medicine University of Rome Tor Vergata; <sup>3</sup>Lymphoproliferative disorders unit Tor Vergata University Hospital (PTV); <sup>4</sup>Department of Biomedicine and Prevention, University of Rome Tor Vergata, Rome, Italy

**Introduction:** Monoclonal gammopathy of undetermined significance (MGUS) and multiple myeloma (MM) are characterized by a plasma cell clonal expansion in the bone marrow. MM incidence increases with advancing age and it is more common in males compared to females. The biological mechanisms driving these differences are still poorly understood. In our work, by a retrospective analysis of serum protein electrophoresis and immunoparesis, we studied the contribution of age and sex on MGUS patients (225) enrolled at University Hospital Tor Vergata from January 2015 to September 2021.

**Methods:** Capillary Electrophoresis was performed to evaluate the role of the serum analytes in diagnosis of MGUS.

**Results:** From our preliminary data we observed that: i) in aged patients (51-90 range of years) MGUS was diagnosed earlier in women (medium age: 60,7 years) than in men (medium age: 65,5 years); ii) we noticed a significant prevalence of MGUS in male patients (60%) compared to female patients (40%); iii) we compared the serum of MGUS patients to the serum of healthy controls and we observed a significant lower concentration of β1 (0,42 gr/dl) among the MGUS patients compared to the healthy controls (0,44 g/dl); MGUS patients also showed a rising of β2 levels (0,43g/dl) compared to β2 healthy controls levels (0,36 g/dl). In addition, we extended the analysis of serum protein to men and women affected by MGUS and we observed a different concentration of β1 and β2 respectively in male and female patients. We measured a lower serum concentration of β1 in male MGUS patients (0,41 g/dl), conversely the concentration of β2 was higher (0,48g/dl). Other parameters related to sex were not defined.

**Conclusions:** Prevalence data of MGUS related to sex and the possible contribution of gender to evolution of MGUS to MM are still unknown. For the first time the retrospective analysis of serum proteins from MGUS patients proves a significant sex-related difference in the levels of beta proteins. Sex hormones and X-chromosome linked immunogenes seem to contribute to gender differences in immunosenescence and immunoreactivity. Immune system alterations in MGUS and MM influence the susceptibility to infections and disease severity. Yet to be determined whether the specific reduction of β1 and the increase of β2

observed in MGUS male patients could be used as a disease severity index and a prognostic tool for possible progression to MM. Further studies are necessary to clarify the existence of relationships between sex and beta proteins in monoclonal gammopathies that could evolve in MGUS.

## Stem Cell Transplantation

### P62

#### RESPONSE TO BNT162B2 SARS-COV-2 VACCINE AND LONG-TERM ANTIBODY PERSISTENCE IN RECIPIENTS OF ALLOGENEIC HEMATOPOIETIC STEM CELL TRANSPLANT

F. Saraceni, A. Fiorentini, S. More, S. Guerzoni, B. Puglisi, B. Corvaro, S. Caucci, S. Menzo, L. Butini, A. Costantini, N. Viola, A.F. Lotito, L. Brunetti, F. Colaneri, I. Scortechini, G. Mancini, M.V. Dubbini, I. Federici, E. Busilacchi, A. Poloni, S. Kordasti, M. Offidani, A. Olivieri

*Ospedali Riuniti Ancona, Italy*

In this prospective observational study, we evaluated the immunogenicity of two BNT162b2 (Pfizer–BioNTech) vaccine doses in allogeneic HSCT recipients compared to healthy controls. IgG antibodies to the receptor-binding domain (RBD) of the S1 subunit of the spike protein of SARS-CoV-2 were analyzed by SARS-CoV-2 IgG II Quant (Abbott, Ireland). All samples that were positive for RBD IgG were tested for neutralizing antibodies (Ichromax Covid-19 nAB, Boditech) and T-cell response (anti-S IFN- $\gamma$  production measured on PBMC by ELISA). Patients older than 18 years who received BNT162b2 vaccine following an HSCT at seven Italian centers were included in the study. Enrolled patients received two successive doses (at 3-week interval) at a median of 15 months (range 2-141) after HSCT. Twenty-nine age-matched health care workers who were vaccinated with BNT162b2 were recruited as the control group. Among the 34 patients evaluable for serological response, three patients were excluded from the analysis as the baseline serology demonstrated previous natural SARS-CoV-2 infection. On w3, after the first vaccine dose 7/31 (23%) patients developed anti-S IgG antibodies as compared to 28/29 (97%) controls ( $p < 0.01$ ). HSCT recipients showed lower antibody titers (median 1.8 BAU, range 0-481) as compared to healthy controls (median 118 BAU, range 6-1172,  $p < 0.01$ ). In univariate analysis, transplant-to-vaccination interval ( $> 12$  months,  $p < 0.01$ ), baseline CD4+ T cell count ( $> 200/\text{mm}^3$ ,  $p = 0.01$ ), and CD4+CD45RA+ T naive cell count ( $> 100/\text{mm}^3$ ,  $p < 0.01$ ) were significantly associated with antibody response after the first vaccine dose. On w5, after the second vaccine dose, 24/31 (77%) of the patients showed antibody response, as compared to 99% of healthy controls ( $p < 0.01$ ); in fact, 71% of non-responders to the first dose developed IgG antibodies after vaccine boost (Figure 1).

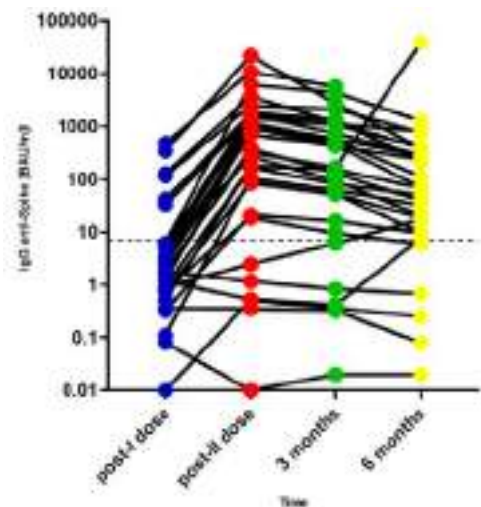

Figure 1. Long term SARS-CoV-2 IgG persistence.

Median antibody titer after second dose was 350 BAU/ml (0-21.731). In univariate analysis, no significant association was found between patient characteristics and immunogenicity after second vaccine dose. When serum of patients positive for anti-S IgG were tested for

neutralizing antibodies, 18% of patients showed non-neutralizing sera. Further, 76% of responders had no T-cell response to S protein. SARS-CoV-2 IgG persistence was re-evaluated 3 and 6 months following vaccination; antibody titers decreased significantly over time, specifically by 54% at 3 months and by 80% at 6 months. In conclusion, patients who received vaccines beyond one year after transplant were more likely to mount anti-S IgG antibodies, which could be due to a broader immune reconstitution, as we observed an enhanced response to single BNT162b2 vaccine dose in patients with higher CD4+ T cell and particularly CD4+CD45RA+ naive T cell counts. Antibody titers decreased significantly six over time, suggesting that repeated booster doses might be needed in these particularly immunocompromised patients.

increase of antibody titers was observed. Our preliminary data show that 7/10 not responding pts (70%) mounted a serological response one month after the third dose, thus indicating the potential role of a booster dose to recover seronegative pts. Immunophenotypic studies on T and B lymphoid subsets, potentially involved in immune response to the vaccine, are ongoing and will be presented at the meeting.

**P63**

**THE THIRD DOSE OF BNT162B2 ANTI-SARS-COV-2 MRNA VACCINATION IS EFFECTIVE AND CAN RESCUE HEMATOPOIETIC STEM CELL TRANSPLANTATION PATIENTS NOT RESPONDING TO THE FIRST TWO DOSES**

I. Attolico<sup>1</sup>, F. Tarantini<sup>2</sup>, C.P. Schifone<sup>2</sup>, A. Mestice<sup>2</sup>, G. De Tullio<sup>1,2</sup>, P. Carluccio<sup>1</sup>, M. Delia<sup>1</sup>, V.P. Gagliardi<sup>1</sup>, T. Perrone<sup>1</sup>, F. Gaudio<sup>1</sup>, C. Longo<sup>1</sup>, A. Giordano<sup>1</sup>, N. Sgherza<sup>1</sup>, P. Curci<sup>1</sup>, R. Rizzi<sup>1</sup>, A. Ricco<sup>1</sup>, A. Russo Rossi<sup>1</sup>, F. Albano<sup>2</sup>, A.M.V. Larocca<sup>3</sup>, L. Vimercati<sup>4,5</sup>, S. Tafuri<sup>6</sup>, P. Musto<sup>1,2</sup>

<sup>1</sup>Hematology and Stem Cell Transplantation Unit, AOUC Policlinico; <sup>2</sup>Department of Emergency and Organ Transplantation, "Aldo Moro" University School of Medicine; <sup>3</sup>Hygiene Unit, AOUC Policlinico; <sup>4</sup>Interdisciplinary Department of Medicine, "Aldo Moro" University School of Medicine; <sup>5</sup>Occupational Medicine Unit, AOUC Policlinico; <sup>6</sup>Department of Biomedical Sciences and Human Oncology, "Aldo Moro" University School of Medicine, Italy

**Introduction:** Patients (pts) with hematological malignancies (HM) undergoing hematopoietic stem-cell transplantation (HSCT) have an increased vulnerability to COVID-19. (Sharma *et al*, Lancet Haematology 2020; Ljungman *et al*, Leukemia 2021). Therefore, a protective vaccination for these subjects is strongly recommended. We previously demonstrated (Attolico *et al*, BJH 2021) that two doses of BNT162b2 anti-SARS-Cov-2 mRNA vaccine can elicit an immune response in 84% of allogeneic and autologous transplanted pts; the main factor influencing serological response is the time elapsed from transplant to vaccination.

**Methods:** In a prospective, cohort study, we evaluated the response of 63 pts (autologous: 21 and allogeneic: 42) to the third dose. Serological tests were performed by a commercially available immunoassay for the quantitative determination of anti-spike IgG antibodies. The cut-off for defining responders was ≥50 AU/ml. Samples were collected four weeks after the third dose. Comparisons between groups were performed using Mann-Whitney and Kruskal-Wallis tests.

**Results:** Table 1 (A,B) reports the main clinical characteristics of pts and response. No side effects were reported. Median antibody titers did not differ among: -the entire cohort of pts, -all the recipients of allogeneic HSCT, -all the recipients of autologous HSCT, -all the responders to the vaccine, -all the responders in the allogeneic and autologous subgroup (Figure 1A). When comparing antibody titers after the second and the third dose, we observed a significant increase in all the pts (Figure 1B, p 0.002) and in the allogeneic group (Figure 1C, p 0.008) but not in the autologous group (Figure 1D, p NS). We stratified pts in three groups, according to the time elapsed from transplant to vaccination: G1:<1 year; G2:1-5 years; G3:>5 years. Median antibody titers after the third dose were significantly different in the three groups (Figure 1E, p 0.02). In all the three groups median antibody titers were significantly higher after the third dose, when compared to those after the second one (Figure 1 F,G,H). Before the third dose, 10/63 pts (16%) had not developed an immune response (8 in allogeneic, 2 in autologous group). Seven out of the ten negative pts showed a response to the third dose (Figure 1I). The three non-responders were: 2 allogeneic transplanted pts (one with active cGVHD, one with active disease on treatment) and 1 autologous transplanted patient with active disease.

**Conclusions:** In our study, pts with a previous history of HSCT tolerated well the third dose of the BNT162b2 vaccine. A significant

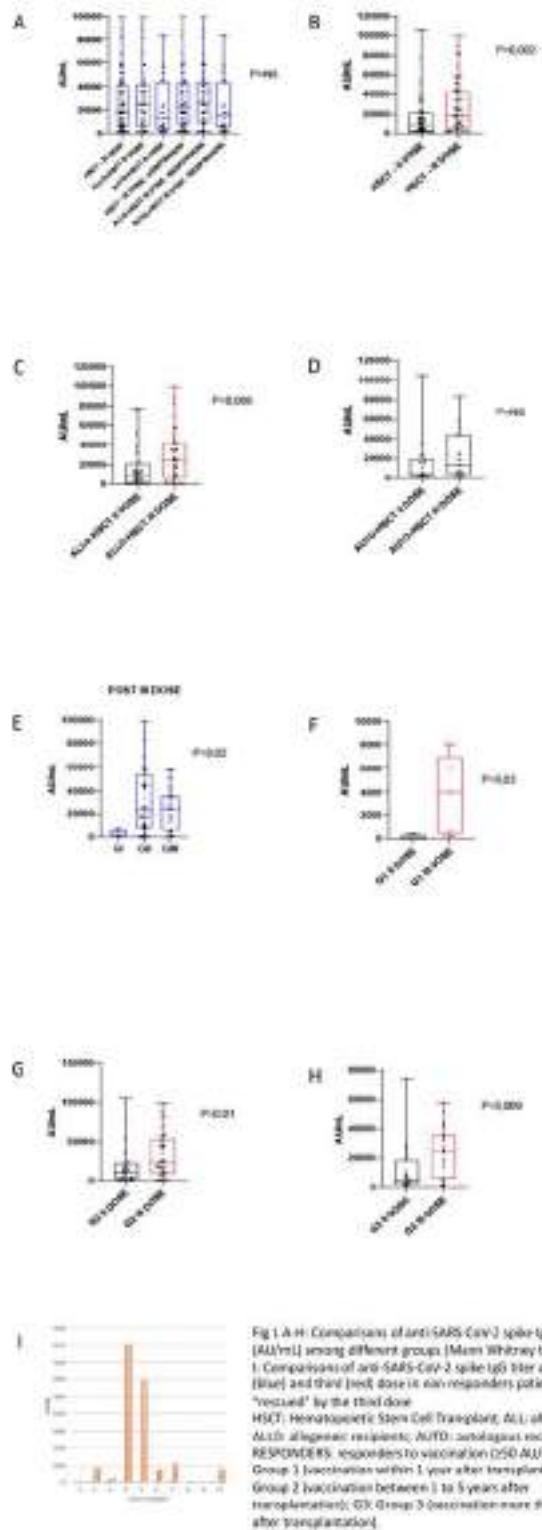

**Figure 1.**

## Immunotherapy and Cell Therapy

P64

### IMMUNE SUPPRESSION OF BONE MARROW V $\gamma$ 9V $\delta$ 2 T CELLS BY BONE MARROW STROMAL CELLS (BMSC) IN MULTIPLE MYELOMA

C. Giannotta<sup>1</sup>, B. Castella<sup>2</sup>, E. Tripoli<sup>3</sup>, C. Riganti<sup>4</sup>, I.C. Salaroglio<sup>4</sup>, M. D'Agostino<sup>5</sup>, M. Massaia<sup>1,3</sup>

<sup>1</sup>Laboratorio di Immunologia dei Tumori del Sangue (LITS), Centro Interdipartimentale di Ricerca in Biologia Molecolare (CIRBM), Università degli Studi di Torino; <sup>2</sup>SCI Laboratorio Analisi, AO S. Croce e Carle, Cuneo; <sup>3</sup>SC Ematologia, AO S. Croce e Carle, Cuneo; <sup>4</sup>Dipartimento di Oncologia, Università degli Studi di Torino; <sup>5</sup>Myeloma Unit, Division of Hematology, University of Torino, Azienda Ospedaliero-Universitaria Città della Salute e della Scienza di Torino, Italy

**Introduction:** V $\gamma$ 9V $\delta$ 2 T cells ( $\gamma\delta$  T cells) are intrinsically prone to sense metabolic and homeostatic changes of myeloma cells and exert anti-tumor functions. However, bone marrow (BM)  $\gamma\delta$  T cells succumb very early to the immune suppressive commitment operated by myeloma cells and bystander cells, including bone marrow stromal cells (BMSC) in the tumor microenvironment (TME). Over-production of phosphoantigens (pAg) and immune-checkpoint (ICP) expression are among the mechanisms involved in the functional exhaustion and immune senescence of BM  $\gamma\delta$  T cells. The recovery of BM  $\gamma\delta$  T-cell antitumor immune functions is the prerequisite to develop innovative cancer immunotherapies.

**Methods:** pAg stimulation of  $\gamma\delta$  T cells from peripheral blood (PB) of healthy donors (CTRL) was conducted in presence of BMSC derived from bone marrow mononuclear cells of Multiple Myeloma (MM) patients. Phenotypic and functional characterization of BMSC-cocultured  $\gamma\delta$  T cells was performed. Phenotypic and metabolic profiles of BMSC of CTRL and MM patients in different stage of disease were analyzed.

**Results:** MM BMSC co-cultures significantly hamper the proliferative responses of CTRL  $\gamma\delta$  T cells to pAg stimulation.  $\gamma\delta$  T-cell degranulation (*i.e.*, CD107 expression) and IFN- $\gamma$  secretion were not affected by MM BMSC. Effector memory CD27<sup>-</sup> CD45RA<sup>-</sup>  $\gamma\delta$  T cells were decreased, whereas naive CD27<sup>+</sup>CD45RA<sup>+</sup>  $\gamma\delta$  T cells were increased, and TIM-3 upregulated in CTRL  $\gamma\delta$  T cells after co-culture with MM BMSC. The inhibitory effect of MM BMSC was dependent on soluble factors and cell-to-cell interactions as shown by Transwell co-culture experiments. MM BMSC analysis showed phenotypic and metabolic alterations consistent with immune suppressor functions, including the expression of PD-L1 and Gal-9 which were significantly increased compared to CTRL BMSC. ICP-ligand (ICP-L) expression was associated with a supraphysiological release of isopentenyl pyrophosphate (IPP), a natural ligand playing a central role in the immune reactivity of  $\gamma\delta$  T cells to microorganisms and stressed cells. The concurrent exposure of BM MM  $\gamma\delta$  T cells to supra-physiological IPP concentrations in the presence of ICP-L expression by MM BMSC may contribute to the functional exhaustion and immune senescence of  $\gamma\delta$  T cells. Metabolic analysis of BMSC from MM patients at diagnosis and relapse, but not in remission, showed an increased metabolism of glucose to lactate via aerobic glycolysis rather than tricarboxylic acid cycle and oxidative phosphorylation in mitochondria. These metabolic changes poison the TME in favor of immune suppressor cells to the expense of immune effector cells.

**Conclusions:** ICP-L expression, IPP over-production and metabolic changes of BMSC contribute to the establishment of the immune suppressive TME in MM and constrain the reactivity of immune effector cells with special regard to  $\gamma\delta$  T cells.

Table 1. A: Patients' characteristics. B: Rates of response and serum anti-SARS-COV2 antibody levels after the third dose. M: male; F: female; ALLO-HSCT: allogeneic hematopoietic stem cell transplantation; AUTO-HSCT: autologous hematopoietic stem cell transplantation; AML: acute myeloid leukemia; ALL: acute lymphoblastic leukemia; SAA: severe aplastic anemia; CML: chronic myeloid leukemia; MDS: myelodysplastic syndrome; NHL: non-Hodgkin lymphoma; MM: multiple myeloma; CMML: chronic myelomonocytic leukemia; CLL: chronic lymphocytic leukemia; HL: Hodgkin lymphoma; G1: Group 1 (vaccination within 1 year after transplantation); G2: Group 2 (vaccination between 1 to 5 years after transplantation); G3: Group 3 (vaccination more than 5 years after transplantation); MAC: myeloablative conditioning; RIC: reduced intensity conditioning; MEL200: melphalan, 200 mg/sqm; FEAM: fotemustine, etoposide, cytarabine, melphalan; BEAM: carmustine, etoposide, cytarabine, melphalan; MUD: matched unrelated donor; HAPLO: haploidentical donor; a-GVHD: acute graft versus host disease; c-GVHD: chronic graft versus host disease.

Table 1A

	ALLO-HSCT (N=42)	AUTO-HSCT (N=21)
SEX: M/F	24/18	11/10
MEDIAN AGE (RANGE)	56.5 (32-68)	57 (20-71)
HAEMATOLOGICAL DISEASE (N)	AML (26), ALL (2), SAA (4), CML (2), MDS (3), NHL (2), MM (1), CMML (1), CLL (1), HL (1)	MM (11), NHL (7), PL (3)
DISEASE STATUS AT VACCINATION: ACTIVE DISEASE/COMPLETE REMISSION	1/41	8/13
G1/G2/G3	4/20/18	1/14/6
CONDITIONING REGIMEN	31 MAC/11 RIC	11MEL200 8 FEAM 2 BEAM
HSCT TYPE	5BILING/MUD/HAPLO 17/21/5	SINGLE/DONOR (MM) 18/0
a-GVHD/c-GVHD	14/1	NA

Table 1B

	RESPONSE TO VACCINATION (THIRD DOSE): RESPONDERS/NON RESPONDERS (%)	ANTIBODY TITER (AU/ML): MEDIAN (MEAN: RANGE)
ALL PATIENTS	60/3 (95/5)	8100 (25800: 0-589540)
ALLO-HSCT	48/3 (95/5)	29584 (27610: 9-98945)
AUTO-HSCT	28/1 (95/5)	13120 (22356: 0-82776)
G1	5/0 (100/0)	3980 (3771: 8617-8032)
G2	32/2 (94/6)	22540 (32207: 9-88954)
G3	23/1 (96/4)	24465 (23658: 0-57651)

**P65****ATP-DEPENDENT INDUCTION OF IDO1 EXPRESSION IN DENDRITIC CELLS AFTER CHEMOTHERAPY TREATMENT IN ACUTE MYELOID LEUKEMIA IS CONTROLLED THROUGH NON-CANONICAL NF-KB SIGNALING VIA P2Y11R**D. Ocadlikova<sup>1</sup>, S. Casella<sup>1</sup>, L. Vitali<sup>1</sup>, I. Pintao<sup>1</sup>, M. Cavo<sup>2</sup>, A. Curti<sup>2</sup><sup>1</sup>Dipartimento di Medicina Specialistica, Diagnostica e Sperimentale, Università di Bologna, Istituto di Ematologia "Seràgnoli"; <sup>2</sup>IRCCS AOU di Bologna, Istituto di Ematologia "Seràgnoli", Italy

**Introduction:** We previously demonstrated that chemotherapy-induced release of ATP from dying AML cells drives dendritic cells (DCs) to upregulate indoleamine 2,3-dioxygenase 1 (IDO1), which in turn is involved in T regulatory cells induction. ATP released from chemotherapy-treated AML cells binds purinergic receptors on DCs thus inducing inflammasome activation (through P2X7R), DC maturation and IDO1 upregulation (both through P2Y11R). Since IDO1 expression was recently associated with non-canonical NF-kB activation through IFN-gamma, we hypothesized the same pathway as a principal intracellular mechanism through which ATP-dependent IDO1 expression in DCs is induced via P2Y11 activation. Moreover, we investigated a potential involvement of inflammasome machinery through P2X7R in IDO1 regulation.

**Methods:** CD14+ derived DCs were cultured with ATP in presence or absence of P2X7R and P2Y11R antagonists (AZ 10606120 dihydrochloride and NF 340, respectively) and inflammasome inhibitors (Bay 11-7082 and Ac-YVAD-cmk), and then used for flow cytometry, western blot or real-time PCR analyses to evaluate DC maturation, IDO1 expression or release of IL-1beta as response pattern of activated inflammasome. Non-canonical NF-kB transcription factors such as Rel-B and p52 were evaluated in the nuclei of treated DCs by western blotting.

**Results:** Our results confirmed that ATP released from chemotherapy-treated AML cells induces DC maturation and IDO1 expression through P2Y11R, while inflammasome activation is mediated by P2X7R. Furthermore, analysis of IDO1 expression in DCs treated with ATP in presence of P2X7R and P2Y11R antagonists, revealed a differential regulation of ATP-dependent IDO1 upregulation via P2Y11R (direct positive effect) and P2X7R (indirect negative effect). However, we did not confirm an involvement of inflammasome in inhibiting IDO1 regulation via P2X7R. Interestingly, we found a positive correlation of cytoplasmic IDO1 expression with the presence of Rel-B, the most important transcriptional factor of non-canonical NF-kB pathway.

**Conclusions:** Our data suggest that ATP-dependent IDO1 upregulation in DCs is induced through non-canonical NF-kB signaling by P2Y11 activation. While ATP activates DC inflammasome via P2X7R, the latter is not involved in IDO1 regulation. A more-in-depth understanding of the intracellular mechanisms of IDO1 regulation has clinical implications for the development of IDO1 inhibitors, especially in combination with immunotherapy and immunogenic chemotherapy.

**P66****A MODIFIED EASIX (M-EASIX) SCORE PREDICTS THE DEVELOPMENT OF GRADE 2-4 CRS IN PATIENTS WITH AGGRESSIVE B-NHL TREATED WITH ANTI CD19 CAR-T CELLS**E. Galli<sup>1,2</sup>, A. Di Rocco<sup>3</sup>, F. Sorà<sup>1,2</sup>, F. Autore<sup>1</sup>, M.A. Limongiello<sup>1</sup>, I. Innocenti<sup>1</sup>, E. Metafuni<sup>1</sup>, S. Giammarco<sup>1</sup>, U. La Rocca<sup>3</sup>, W. Barberi<sup>3</sup>, S. Pepe<sup>3</sup>, M. Ansuinelli<sup>3</sup>, L. Laurenti<sup>1,2</sup>, A. Bacigalupo<sup>1,2</sup>, P. Chiusolo<sup>1,2</sup>, A. Iori<sup>3</sup>, M. Martelli<sup>3</sup>, S. Hohaus<sup>1,2</sup>, S. Sica<sup>1,2</sup><sup>1</sup>Dipartimento di Diagnostica per Immagini, Radioterapia Oncologica ed Ematologia, Fondazione Policlinico Universitario A. Gemelli IRCCS; <sup>2</sup>Sezione di Ematologia, Dipartimento di Scienze Radiologiche ed Ematologiche, Università Cattolica del Sacro Cuore; <sup>3</sup>Dipartimento di Medicina Traslazionale e di Precisione, Università di Roma Sapienza, Italy

**Introduction:** Predicting the occurrence of a severe cytokine release syndrome (CRS) and of immune effector cell-associated neurotoxicity

syndrome (ICANS) represents a challenge in the management of CAR-T cell therapy. A major focus for research has been the role of cytokines and their interactions with endothelium. The Endothelial Activation and Stress Index (EASIX) score, is a marker of endothelial damage that associates with survival in patients undergoing allogeneic stem cell transplantation.

**Methods:** In this study, we aimed to assess the predictive value of a modified-(m)EASIX score for CRS and ICANS. m-EASIX was calculated as described by Pennisi et al (BloodAdv 2021) as [CRP (mg/dL) x LDH (U/L)/ platelets count (10<sup>9</sup> cells/L)]; we applied log transformation using base 2 (log<sub>2</sub>) in order to reduce skewness.

**Results:** We retrospectively analyzed 33 adult patients with DLBCL/PMBL treated with either tisa-cel or axi-cel in two CAR-T centers in Rome between 2019 to 2021. Seven patients did not develop CRS, seven developed grade 1 CRS, while 19/33 (56%) patients developed grade 2-3 CRS. In a rank-sum analysis, m-EASIX at baseline, pre-infusion, day +2 and day +4, was strongly associated with occurrence of CRS graded 2 or more (Figure 1A). ICANS grade 2-4 was observed in two patients. We did not find any association between mEASIX scores and ICANS. Among the three parameters CRP, LDH and platelet counts, levels of CRP was the strongest predictor for CRS, being significantly associated with occurrence of CRS grade >2 at all time points (p ranges from 0.004 to 0.0005). There was a trend for prediction of CRS grade >2 by LDH levels at baseline, day 2 and day 4 (p=0.07, p=0.06 and p=0.09) and by platelet counts at day 2 (p=0.08). We next aimed to identify a cut-off of mEASIX for predicting CRS of grade 2 or more, that could possibly be used as a threshold to alarm the physician in intensifying patient monitoring. Using a ROC analysis we found that an m-EASIX value of 4.72 at day 2 and day 4 predicted the occurrence of CRS>2 on the same day with a sensitivity of 79% (95% C.I., 62-91%) and a specificity of 70% (95% C.I., 51-85%), with an AUC of 0.79 (95% C.I., 0.65-0.88) (Figure 1B).

**Conclusions:** We found that mEASIX is increased in patients at risk to develop a grade >2 CRS, even if the score was assessed at start of the conditioning regimen or at the time of infusion of CAR-T cells. Moreover, we identified a cut-off value of mEASIX that can discriminate with acceptable sensibility and specificity patients at risk of developing grade >2 CRS on the same day. This parameter could help in intensifying patient monitoring before severe CRS occurrence, possibly facilitating an immediate intervention.

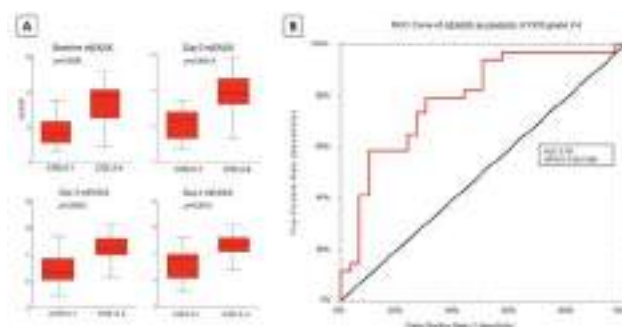

Figure 1.

**P67****IN VITRO FUNCTIONAL ACTIVITY OF CARCIK-CD19 CELLS COMPARED TO UNMODIFIED CIK CELLS COMBINED WITH BISPECIFIC ANTIBODY BLINATUMOMAB**S. Zaninelli<sup>1,2</sup>, S. Panna<sup>1</sup>, I. Cattaneo<sup>1</sup>, C. Cuofano<sup>1</sup>, E. Gotti<sup>1</sup>, J. Golay<sup>1,3</sup>, M. Introna<sup>1</sup><sup>1</sup>Laboratorio di terapia cellulare e genica "G. Lanzani", UOC Ematologia, ASST Papa Giovanni XXIII; <sup>2</sup>Università degli studi di Milano-Bicocca; <sup>3</sup>Fondazione per la ricerca ospedale maggiore FROM, Italy

**Introduction:** Although cytokine Induced Killer (CIK) cells show

anti-tumor activity *in vitro* and *in vivo*, there remains a need to increase their efficacy and specificity. This could be reached using either bispecific antibodies or chimeric antigen receptor (CAR) modifications. The aim of this study was to compare the *in vitro* function of CIK cells combined with soluble CD3xCD19 bispecific antibody Blinatumomab (CIK-Blina) or modified with two different anti-CD19 CAR molecules (CAR-CIK-MNZ and CARCIK-BG2, carrying the same anti-CD19 moiety with different signaling modules, CD28-OX40-CD3 $\epsilon$  and CD8-41BB-CD3 $\epsilon$ , respectively). The CARCIK-MNZ are being used by our group in clinical trials (FT01CARCIK and FT03CARCIK; Eudract n. 2017-000900-38 and 2020-005025-85) and the CARCIK-BG2 was designed on the structure of Tisagenlecleucel CAR (Novartis), cloned however in a transposon vector.

**Methods:** Unmodified CIK cells were generated in 21 days cultures, starting from peripheral blood mononuclear cells (PBMCs) stimulated with IFN- $\gamma$  on day 0, anti-CD3 on day 1, and rhIL-2 thereafter. Unmodified CIK were tested alone or in presence of 10 ng/ml blinatumomab. To generate CAR-modified CIK cells, the same procedure was used but PBMCs were first co-transfected on day 0 with the two plasmids encoding the Sleeping Beauty (SB) transposase and the CAR-CD19 molecules. Proliferation, cytotoxic activity, and cytokine production induced by Blinatumomab in CIK or by the two different CARCIK-CD19 products were analysed *in vitro* in response to the CD19<sup>+</sup> REH ALL cell line target, at different effector to target ratios (E:T). Methods included CFSE assay, calcein-AM release and measurement of cytokines by beads capture assays and flow cytometry, respectively.

**Results:** Proliferation of CIK-Blina and CARCIK-CD19 was induced more strongly with increasing number of REH target cells (*i.e.* decreasing E:T ratio, from 10:1 to 1:10). Proliferation of CIK-Blina and CARCIK-MNZ was slightly higher than that of CARCIK-BG2 (mean proliferation index 11.4, 12.6 and 6.4 at E:T 1:1, respectively)( $p < 0.05$ ). Cytotoxicity increased with increasing E:T ratio, as expected, and was not significantly different between the effectors (mean cytotoxicity of 55.8%, 30.9% and 36.1%, respectively versus 11.2% for CIK alone at E:T 10:1)( $p < 0.05$  in all cases). Finally, all cell types released IFN- $\gamma$ , TNF- $\alpha$  and IL-8 in response to REH cells (E:T 1:1). IFN- $\gamma$  production was significantly higher for CIK-Blina and CARCIK-MNZ compared to CARCIK-BG2 ( $p < 0.05$ ).

**Conclusions:** These data suggest that the addition of Blinatumomab renders CIK cells as efficacious *in vitro* as gene-modified CARCIK-CD19 cells, generated using different CAR-CD19 molecules. To complete our knowledge of the system, the intracellular signaling, as well as strength of the immune synapsis following target addition are being analyzed. Comparisons are also planned *in vivo* in a mouse model.

## P68

### HIGH LEVELS OF CIRCULATING MONOCYtic MYELOID DERIVED SUPPRESSIVE-LIKE CELLS CORRELATE WITH THE ONSET OF CAR T-CELL INFUSION-RELATED SEVERE COMPLICATIONS IN LYMPHOMA PATIENTS

S. De Matteis<sup>1</sup>, M. Dicaldo<sup>1,2</sup>, B. Casadei<sup>1,2</sup>, N. Laprovitera<sup>1</sup>, G. Storci<sup>1</sup>, B. Sinigaglia<sup>2</sup>, F. Barbato<sup>1,2</sup>, P.L. Zinzani<sup>1,2</sup>, M. Bonafè<sup>2</sup>, F. Bonifazi<sup>1</sup>

<sup>1</sup>IRCCS Azienda Ospedaliero-Universitaria di Bologna; <sup>2</sup>Department of Experimental, Diagnostic and Specialty Medicine (DIMES), University of Bologna, Italy

**Background:** Chimeric antigen receptor (CAR) T-cell therapy is associated with relevant, life-threatening side-effects such as cytokines release syndrome (CRS), macrophage activation syndrome (MAS), ipo/agammaglobulinemia, immune effector cell-associated neurotoxicity syndrome (ICANS) and infections. Here, we show the preliminary results of a prospective biological study conducted on a cohort of 12 patients affected by Relapsed/Refractory B-cell non-Hodgkin Lymphoma subtypes receiving commercial/AIFA approved anti-CD19 CAR-T cell products at IRCCS-Azienda Ospedaliero-Universitaria of Bologna.

**Methods:** We report a cytofluorimetric analysis of circulating monocytic-myeloid derived suppressive-like cells (MO-MDSC-LC) on peripheral blood samples from patients before receiving lymphodeplet-

ing chemotherapy with fludarabine (25-30 mg/m<sup>2</sup>) and cyclophosphamide (250–500 mg/m<sup>2</sup>). We monitor hospitalized patients for at least 14 days following cells infusion to guarantee a better and close monitoring of adverse events. We compared the onset of complications between patients with MO-MDSC-LC lower and higher median value. A p-value  $< 0.05$  was considered statistically significant.

**Results:** Among the 12 patients infused, 9 developed a CRS (any grade). In most cases, CRS was grade 1; with only 2 out of 12 patients experiencing CRS grade 3. Nine patients received Tocilizumab, with a median number of 3 doses (range 1–3). Four patients developed ICANS (any grade): 2 had grade 2 and 2 had grade  $> 3$  and first-line therapy with Dexamethasone (10 mg/kg per 4) was administered. The median MO-MDSC-LC value was higher in patients who experienced a CRS of grade  $\geq 2$  and/or ICANS of grade  $\geq 2$  in respect with those without severe complications ( $4.9 \pm 1.1$  vs  $0.65 \pm 0.8$ ;  $p = 0.0001$ , respectively) (Figure 1).

**Conclusions:** In this analysis, high MO-MDSC-LC percentage shows a relevant role as predictive marker for severe complications. These findings suggest that the analysis of circulating MO-MDSC-LC could be used to select the patients who will develop a severe toxicity after CAR T-cell therapy. New treatments targeting MDSC-LC could be developed for patients with higher levels of these cells in peripheral blood.

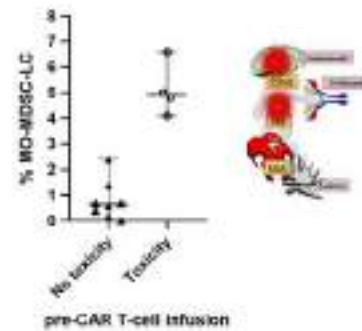

Figure 1.

## P69

### TRUNCATED CD20 AS SUICIDE GENE IN CARCIK THERAPY

C. Cuofano, F. Correnti, I. Cattaneo, S. Zaninelli, S. Panna, M. Introna, J. Golay

ASST Papa Giovanni XXIII, UOC Ematologia, Laboratorio Lanzani, Bergamo, Italy

**Introduction:** The CD20 molecule, transduced and expressed on the surface of allogeneic T cells for adoptive therapy, can act both as a selection marker and as a suicide gene following treatment with anti-CD20 monoclonal antibodies (mAbs). We wished to optimize the method in the context of CAR-modified allogeneic Cytokine Induced Killer cells (CIK) for cancer therapy.

**Methods:** To improve the safety and efficacy of this suicide strategy, several modifications were introduced: 1) a transposon-based transfection approach was used to express the CD20 protein in CIK cells, instead of retroviral vectors, using the more efficient Sleeping Beauty 100 transposase (SB100). 2) The human CD20 cDNA was truncated at its C-terminus (CD20t) to generate an inert protein lacking signaling capability. 3) CD20t cDNA was codon optimized and the  $\beta$ -actin 3'UTR was introduced, to increase transduced CD20t mRNA stability and protein expression.

**Results:** The conditions for transfection of peripheral blood mononuclear cells with improved CD20t plasmid and SB100 transposase were optimized and cells cultured to generate CIK. Transfected CIK expressed high levels of CD20t on 11-13% of cells after 21 days culture. In order to verify the efficiency of selection of transfected CD20t+ cells, an immunoselective magnetic column was used on day 10 of culture. Start-



ing from 8.2% CD20t+ cells, 99.6% pure CD20t CIK cells were obtained. Next, in order to demonstrate the efficacy of CD20t as a suicide gene, the capacity of either anti-CD20 mAbs rituximab or ofatumumab to lyse CD20t+ cells was verified in cytotoxicity dependent cytotoxicity (CDC) assays in presence of 20% human serum as source of complement. As expected, ofatumumab induced a more efficient CDC (approximately 80%) compared to rituximab (52-62%). The latter was in any case much higher than historical CDC data of T cells transduced with full-length CD20 retroviral vector (lysis <10% with rituximab in the same conditions). Finally we tested the feasibility of using CD20t in co-transfection with a CAR in CIK cells. For this purpose, the CD20t and CAR-CD19 transposon vectors were co-transfected at a 2:1 ratio, together with SB100. After 10 days of culture, the CD20t positive cells were purified from mean 12.7% to 98.7% after a single round of selection on anti-CD20 immunoaffinity columns. Most CD20t cells were also CAR-CD19+ (89.9% double positive) and only 0.2% CARCD19+ cells were CD20t- post-purification, compared to 4.2% before. The efficiency of CDC of CARCIK-CD19 co-transfected with CD20t was mean 84% with ofatumumab.

**Conclusions:** The optimized transposon-based CD20t efficiently performed the function of selection marker and suicide gene in the context of co-transfection of CIK with a CAR. The system may be applied in the future to novel CAR more likely to have toxicity *in vivo* due to cross-reactivity with normal tissues. Bicistronic vectors may be developed to guarantee 100% co-expression of CD20t and CAR.

## P70

### CD19 COMPLETE OR PARTIAL LOSS IS A MAJOR MECHANISM OF RELAPSE IN DLBCL PATIENTS TREATED WITH CD19-DIRECTED CAR-T CELLS: EXPERIENCE OF PERUGIA HEMATOLOGY CENTER

V.M. Perriello, L. Falini, L. Ruggeri, A. Venanzi, T. Zei, R. Iacucci-Ostini, A. Pierini, S. Ballanti, E. Tiacci, B. Falini

Centro Ricerche Onco-Ematologico, Università degli Studi di Perugia, Italy

**Introduction:** Chimeric antigen receptor (CAR)-T cells targeting CD19 have revolutionized the therapy of relapsed/refractory (r/r) Diffuse Large B-cell Lymphomas (DLBCLs). However, the biological determinants for the clinical success remain yet poorly characterized. We retrospectively analysed r/r DLBCL patients treated with CD19 CAR-T cells at Perugia Hematology Center with the aim to identify such determinants, focusing on assessment of CD19 antigen escape at relapse and to comparison of T cells composition between apheresis and manufactured product.

**Methods:** Between September 2020-November 2021, 13 DLBCL patients, 8 not otherwise specified (NOS) e 6 transformed follicular lymphoma (tFL) were treated with commercial CD19 CAR-T cells (11 Tisacel, 2 Axi-cel). Efficacy was evaluated through PET-CT scan 1, 3 and 6 months after CAR T-cell infusion. To investigate CD19 antigen escape, paired immunohistochemistry (IHC) and RNA sequencing for CD19 detection were performed on tissue biopsies before therapy and at relapse. IHC for CD19 was performed using mAbs recognizing the CD19 epitope targeted by CAR-T cells (to exclude exon-2 splicing) and another epitope. Multi-parameter flow cytometry (FC) was done to detect CAR T-cells and to assess markers of T-cell differentiation/activation (CD3, CD4, CD8, CD56, CD45RA, CD62L, CD27, CD28) in both apheresis and manufactured product. CAR-T cells in pathological samples were also detected by a newly developed immune-alkaline phosphatase technique (Figure 1).

**Results:** Median age at time of CAR-T therapy was 54 years (range 25-70) and 61% of patients were male. Median number of prior treatments was 5 (range 3-12), and 8 patients had undergone prior autologous HSCT. By day-30 post-treatment PET scan, 13 patients (100%) achieved complete response (n=11) or partial response (n=2). Among all responding patients, 5 relapsed (4 at three and 1 at six months). Notably, IHC analysis of samples collected at relapse showed complete CD19 antigen loss in 3 patients (confirmed by RNA seq) and CD19 antigen partial loss in the other two relapsed patients (Figure 2). CRS was observed in 6

patients (only 1  $\geq$  grade 3), while 1 patient experienced an early CNS relapse mimicking an ICANS. No relationship was observed between efficacy and CAR-T cell product composition at apheresis or at infusion. CAR T-cell expansion peaked over 20 CAR-T cells/mm<sup>3</sup> between day 7 and 14 in the peripheral blood in all patients except one (actually in remission).

**Conclusions:** Complete or partial loss of CD19 was a major mechanism of relapse in our DLBCL patients treated with CD19-directed CAR-T cells. This finding points to the importance of immunohistochemical studies at relapse, using an extended panel of monoclonal antibodies aimed to exclude CD19 escape and to identify the expression of other B cell markers (e.g. CD20) suitable for targeting with bispecific antibodies or alternative CARs, following CD19 escape.

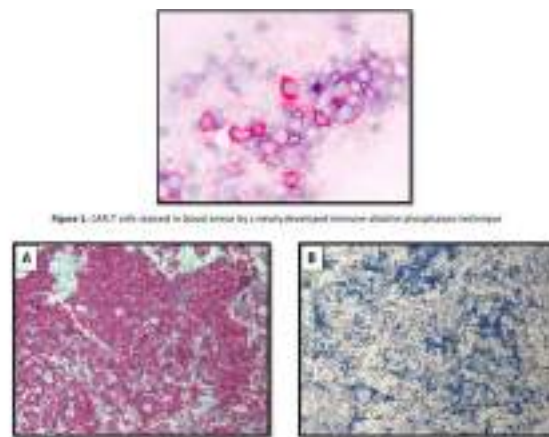

Figures 1 and 2.

## Benign Hematology (Red Cell Disease Thrombosis and Hemostasis)

P71

### DISSECTING THE MOLECULAR GENETICS AND PATHOGENESIS OF HEREDITARY DYSERYTHROPOIETIC ANEMIAS

R. Marra<sup>1,2</sup>, I. Andolfo<sup>1,2</sup>, B.E. Rosato<sup>1,2</sup>, A. Iolascon<sup>1,2</sup>, R. Russo<sup>1,2</sup><sup>1</sup>Dipartimento di Medicina Molecolare e Biotecnologie Mediche, Università di Napoli "Federico II"; <sup>2</sup>CEINGE, Biotecnologie Avanzate

**Introduction:** Hereditary anemias (HAs) are disorders with a highly variable clinical picture. Within HAs, congenital dyserythropoietic anemias (CDAs) are hypo-productive anemias due to various kinds of abnormalities during late stages of erythropoiesis. Among them, CDAI is caused by biallelic mutations in *CDAN1* and *C15orf41*, which is still an uncharacterized gene. Differential diagnosis, classification, and patient stratification of CDAs and related HAs are often difficult, particularly between CDAs and enzymatic defects, such as pyruvate kinase deficiency (PKD). The aim of this study was to establish an NGS-based diagnostic workflow for HAs and to demonstrate how it helped to unravel novel aspects of erythropoiesis in the overall scenario of hereditary anemias.

**Methods:** Targeted-NGS; ELISA assay; Cell cultures; qRT-PCR; Western Blot; Flow cytometry.

**Results:** Our NGS approach highlighted that, among patients originally suspected of CDA, 24.4% of them exhibited a final diagnosis of chronic anemia due to enzymatic defects, mainly PKD. Indeed, the analysis of the main erythroid markers, such as erythroferrone, soluble transferrin receptor, and erythropoietin, demonstrated that PKD patients showed a dyserythropoietic component that may underlie the frequent misdiagnosis with CDA patients, particularly those with clinical diagnosis of CDAI. Within these latter, we herein identified three cases of CDAI caused by three novel variants in *C15orf41*. Functional studies demonstrated that variants differentially affect *C15orf41* gene and protein expression. Both Y94S and H230P variants accounted for impaired erythroid differentiation in K562 cells overexpressing both mutants, while the H230P mutant exhibits an increased S-phase of the cell cycle. We demonstrated also that *C15orf41* wild-type protein exhibits mostly a nuclear localization, is mainly expressed during G1/S phase, and is degraded by the ubiquitin-proteasome pathway. Finally, gene expression of *C15orf41* and *CDAN1*, is tightly correlated, suggesting a shared mechanism of regulation between the two genes.

**Conclusions:** This study pointed out the relevance of genetic testing for the achievement of a correct diagnosis of CDAs and other HAs, for the treatment of these conditions, and for elucidating their underlying pathogenic mechanisms.

P72

### PHARMACOKINETIC / PHARMACODYNAMIC (PK/PD) SIMULATIONS GUIDE SELECTION OF THE DOSE FOR ADMINISTRATION OF EFGARTIGIMOD PH20 SUBCUTANEOUSLY IN A PHASE 3 CLINICAL TRIAL IN PATIENTS WITH PRIMARY IMMUNE THROMBOCYTOPENIA

W. Ghanima<sup>1</sup>, V. McDonald<sup>2</sup>, S. Jain<sup>3</sup>, M. Carpenedo<sup>4</sup>, E.N. Oliva<sup>5</sup>, A. Hultberg<sup>6</sup>, D. Gandini<sup>6</sup>, E. Hofman<sup>6</sup>, T. Van Bragt<sup>6</sup>, W. Parys<sup>6</sup>, B. van Hoorick<sup>6</sup>, M. Godar<sup>6</sup>, F. Rocca<sup>6</sup>, Y. Miyakawa<sup>7</sup>, C.M. Broome<sup>8</sup>

<sup>1</sup>Departments of Medicine, Hematology-Oncology, and Research, Østfold Hospital Trust and the Department of Hematology, Oslo University Hospital and Institute of Clinical Medicine, University of Oslo; <sup>2</sup>Barts Health NHS Trust; <sup>3</sup>RUSH University Medical Center; <sup>4</sup>ASST Ospedale San Gerardo di Monza; <sup>5</sup>Haematology Unit, Grande Ospedale Metropolitano; <sup>6</sup>Argenx Ghent, Belgium; <sup>7</sup>Saitama Medical University Hospital; <sup>8</sup>Georgetown University

**Introduction:** Efgartigimod is a human IgG1-derived Fc fragment that binds with high affinity to FcRn in a pH dependent way, resulting

in a blockade of FcRn-mediated recycling of IgGs. This leads to rapid degradation of all IgGs, including disease-associated autoantibodies. The efficacy, safety, tolerability, and pharmacokinetic (PK) and pharmacodynamic (PD) profile of IV efgartigimod were assessed during a Phase 1 study, Phase 2 studies in patients with Myasthenia gravis (MG) and immune thrombocytopenia (ITP), and a Phase 3 study in MG. These demonstrated that a dose of 10 mg/kg, administered in four weekly (qw) IV infusions, achieves close to maximal IgG reduction and a significant reduction of pathogenic autoantibodies in patients with ITP and MG; this dose was well tolerated in all populations. Based on the results of the Phase 2 study in primary ITP, a Phase 3 study was designed for IV administration in patients with persistent or chronic primary ITP (ADVANCE NCT04188379). To allow for SC administration of efgartigimod at a dose that achieves a similar PD effect to IV 10 mg/kg, a co-formulation with rHuPH20 SC was developed. Here we describe the dose selection process for the SC dose to be used in a Phase 3 study of patients with persistent or chronic ITP.

**Methods:** PK and PD data from a Phase 1 study, (n=32 receiving 750 mg, 1250 mg, 1750 mg, or 10 mg/kg single SC injections of efgartigimod co-mixed with rHuPH20), were used for a PK/PD analysis to predict the efgartigimod PH20 SC dose that would result in a similar PD effect to the benchmark dose from previous studies of 10 mg/kg IV.

**Results:** Weekly SC administration of 1000 mg efgartigimod co-mixed with 2000 U/mL rHuPH20 was predicted to result in comparable maximum total IgG reduction after the 4th SC injection as after the 4th IV infusion of 10 mg/kg administered qw. Additionally, the area under the curve for total IgG concentration after the 4th dose and trough IgG reduction were predicted to be comparable between weekly 1000 mg SC and the weekly 10 mg/kg IV benchmark dose. No statistically significant effect of body weight on the PK and PD of efgartigimod PH20 SC was found.

**Conclusion:** These results informed the weekly SC dose administration schedule in ADVANCE SC, a Phase 3, multicenter, randomized, double-blinded, placebo-controlled trial (NCT04687072) for evaluation of efficacy and safety of efgartigimod PH20 SC in adults with persistent or chronic primary ITP. Efgartigimod PH20 SC or placebo PH20 SC will be given weekly on visits 1-4 and then either weekly or every other week from visits 5 to 16, determined by platelet counts. The frequency of administration will remain unchanged for the last 7 weeks (visits 17 to 24) to evaluate the sustainable platelet count improvement as the primary objective. Secondary objectives include extent of disease control, bleeding events, and quality of life assessments.

P73

### EFGARTIGIMOD: A NOVEL FC RN ANTAGONIST IN THE TREATMENT OF AUTOIMMUNE DISEASES

H. de Haard, W. Parys, P. Ulrichs, F. Rocca, A. Guglietta, J. Beauchamp

Argenx Ghent, Belgium

**Introduction:** Immunoglobulin G (IgG) autoantibodies play a key role in the pathogenesis of several autoimmune diseases including immune thrombocytopenia (ITP), pemphigus vulgaris and neurological conditions such as myasthenia gravis (MG) chronic inflammatory demyelinating polyneuropathy (CIDP) and myositis.

**Methods:** The neonatal Fc receptor (FcRn) is the central regulator of IgG homeostasis protecting IgG (including pathogenic IgG autoantibodies) and albumin from lysosomal degradation and increasing their half-life. Therapeutic blocking of FcRn results in a reduction of all IgG subtypes, which makes it a prime target for potential treatment of a broad population of patients with autoimmune disorders, while maintaining normal immunological responses. Efgartigimod (EFG), an FcRn antagonist, is a human IgG1-derived Fc-fragment that outcompetes endogenous IgG binding, reduces recycling and increases IgG degradation.

**Results:** The completed Phase 3 study in MG (ADAPT) as well as Phase 1 and 2 studies have shown that EFG rapidly and consistently reduced over 60% of IgG without impacting IgM, IgA or albumin while recording notable clinical improvements. EFG also showed clinical effi-

cacy in Phase 2 trials in ITP and PV. Phase 2/3 studies in CIDP (ADHERE), bullous pemphigoid (BALLAD), and myositis (ALKIVIA), and Phase 3 studies in ITP (ADVANCE) and PV (ADDRESS) are ongoing. In all studies to date, EFG was generally well tolerated and adverse events were mainly mild to moderate.

*Conclusion:* FcRn inhibition by EFG is a promising potential therapeutic option for a number of autoimmune diseases mediated by pathogenic IgG autoantibodies.